



Smalley[®]
Steel Ring Company

50
FIFTY YEARS 

**SMALLEY
WAVE
SPRINGS**



**SPIROLOX
RETAINING
RINGS**



**CONSTANT
SECTION
RINGS**



**STOCK
SIZES**

Over 10000 Standards
Carbon & Stainless Steel

**SPECIAL
DESIGNS**

5 mm - 3000 mm
0,200 in - 120 in
No-Tooling-Charges™

**METRIC
ENGINEERING &
PARTS CATALOG**

www.smalley.com
+1 847 719 5900
info@smalley.com

Smalley Wave Springs

All Springs Are Not Equal®

free samples • free CAD models



SAVE SPACE

Reduce spring heights by up to 50% compared to coil springs

Same force and deflection as coil springs

Fits in tight radial and axial spaces

STAINLESS STEEL FROM STOCK

4000 stock sizes in carbon and stainless steel

Available from 6 mm to 400 mm diameters from stock

No-Tooling-Costs™ on specials; available from 5 mm to 3000 mm



SMALLEY WAVE SPRING



COIL SPRING

www.smalley.com



Lake Zurich, IL • USA • +1 847 719 5900 • info@smalley.com



Coignières • France • +33 130 131 575 • europe@smalley.com



Alingsås • Sweden • +46 322 611 770 • nordic@smalley.com



About Smalley

Smalley Steel Ring Company 4

About Wave Springs

General Spring Information/Comparator 12
Spring Applications 15

Wave Springs From Stock

Series	Spring Type	
SSB	Bearing Pre-Load Single Turn	18
	Bearing Cross Reference Chart	20
SSR	IMPERIAL Gap/Overlap Single Turn	22
SSR-N	IMPERIAL Narrow Single Turn	24
RW	IMPERIAL Wavo (Round Wire) Single Turn	25
CM/CMS	Crest-to-Crest	26
C/CS	IMPERIAL Crest-to-Crest/Shim Ends	33
SSRS	IMPERIAL Shim	40
	Spring Tester/Fatigue Tester	41

About Retaining Rings

General Ring Information 42
Ring Selection Guide/Ring Interchange Listing 44
Ring Applications 47
Assembly/Removal Methods 50

Internal Retaining Rings From Stock

Series	Rating, Ring Type	
VHM	Light Duty Single Turn, Spirolox	52
EH	Aerospace, Spirolox	54
DNH	DIN, Spirolox	56
FH	DIN, Constant Section	58
HHM/HHMU	Hoopster	60
HH/HHU	IMPERIAL Hoopster	61
VH	IMPERIAL Light Duty Single Turn, Spirolox	62
WH	IMPERIAL Medium Duty 2-Turn, Spirolox	64
WHW	IMPERIAL WaveRing, Spirolox	67
WHT	IMPERIAL Medium Heavy Duty 2-Turn, Spirolox	68
WHM	IMPERIAL Heavy Duty 2-Turn, Spirolox	70
FHE	IMPERIAL Heavy Duty Single Turn, Constant Section	72
XAH	IMPERIAL Constant Section	74
XDH	IMPERIAL Constant Section	76
	ID/OD Lock	77

External Retaining Rings From Stock

Series	Rating, Ring Type	
VSM	Light Duty Single Turn, Spirolox	78
ES	Aerospace, Spirolox	80
DNS	DIN, Spirolox	82
FS	DIN, Constant Section	84
HSM	Hoopster	86
HS	IMPERIAL Hoopster	87
VS	IMPERIAL Light Duty Single Turn, Spirolox	88
WS	IMPERIAL Medium Duty 2-Turn, Spirolox	90
WSW	IMPERIAL WaveRing, Spirolox	93
WST	IMPERIAL Medium Heavy Duty 2-Turn, Spirolox	94
WSM	IMPERIAL Heavy Duty 2-Turn, Spirolox	96
FSE	IMPERIAL Heavy Duty Single Turn, Constant Section	98
XAS	IMPERIAL Constant Section	100
XDS	IMPERIAL Constant Section	102

Laminar Seal Rings 103

Engineering

Special Designs 110
Introduction to Smalley Engineering 111
Materials / Finishes 112
Spring Design 117
Ring Design 122
End Configurations 128
Hoopster Design 129
Smalley Website 130
Spring Checklist 132
Ring Checklist 133
How to Order 134
Glossary 136
Sample Request Form 138

Copyright 2013 by
Smalley Steel Ring Company
Lake Zurich, IL 60047 USA
All rights reserved

The following are trademarks of Smalley Steel Ring Company: Gap-Type, No-Tooling-Costs, No-Tooling-Charges, Overlap-Type.

The following are registered trademarks of Smalley Steel Ring Company: All Springs Are Not Equal, Circular-Grain, Crest-to-Crest, Edgewound-Coiled, No Ears to Interfere, Quick Ship, Smalley, Spirawave, Spirolox, WaveRing, Wavo, Hoopster.

Company Profile



Smalley Steel Ring Company is prepared to quickly and efficiently assist our global customers with our network of regional offices serving Europe, Latin America and Asia Pacific. Our local staff has extensive product knowledge and is always available to help with part selection, application design, technical and customer support. Smalley staff is able to offer consultation in English, French, Swedish, Spanish and German to better serve you. Smalley's international locations allow us to offer customized global supply chain solutions to meet your worldwide manufacturing requirements.

Founded in 1918 as a supplier of precision automotive piston rings, Smalley Steel Ring Company had many years of successful growth in an expanding marketplace. Having had a variety of products throughout the years, it wasn't until 1963, when present ownership began the development of products in the wire forming industry. Spiral Retaining Rings and Wave Springs emerged and Smalley developed into a reputable manufacturer of precision rings, springs & wire forms. But one thing never changed from years back, and that is our commitment to providing ever-higher levels of quality, performance, deliverability, and value to our customers. Today, Smalley Steel Ring Company is a market leader in the industrial retaining ring and wave/compression spring business; a position we work hard to maintain and build upon.

Every Smalley ring and spring is engineered and manufactured to the highest quality standards using skills and processes we have honed over three quarters of a century. Our obsession with quality, combined with our near-perfect record of on-time delivery, has earned us an approved supplier status with leading OEM manufacturers around the world. Due to the ceaseless demands we place upon ourselves, Smalley has won the coveted title of Preferred Source in the most demanding applications: automotive, agriculture, aerospace, electronics, appliance, industrial, medical and power generation.

While we are understandably proud of the recognition we have received, ultimately, it is our products that set us apart. Unlike stamped rings and springs, which are die-stamped through the metal grain, our edgewound rings and springs have a circumferential metal grain structure that gives them exceptional strength, dimensional stability, and predictable performance characteristics.

Finally, every Smalley ring and spring is backed by our continued support. We are constantly searching ways to expand and improve our Customer Service and Engineering/Technical Assistance. We welcome your comments and your design challenges. Engineers are available to assist with any design questions. **+1 847 719 5900** or visit our website today!

Mission Statement

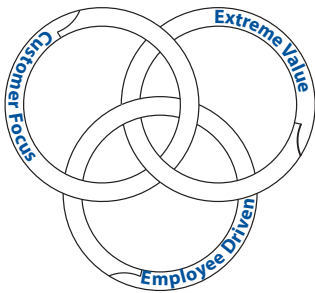

Customer Focus:

Always deliver the very best quality ON TIME with exceptional service.

Employee Driven Organization:

Attracting creative individual talent with a passion for TEAM SUCCESS.

Products with Extreme Value:

Having unique characteristics that differentiate SMALLEY PRODUCTS within our customer's innovative designs.

Products

All of Smalley's wave springs and retaining rings are manufactured with our unique edgewinding manufacturing process. This eliminates any tooling charges, greatly increases design flexibility and reduces lead times as dies do not have to be produced.



Retaining Rings

Unlike die-stamped circlips / retaining rings, Spirolox Retaining Rings and Constant Section Rings are coiled on edge to the exact diameter required. They have a uniform cross-section (or to use our terminology, No Ears To Interfere within an assembly) and are free of burrs. Spirolox Retaining Rings meet military and aerospace specifications and are found in thousands of mechanical products around the world.



Wave Springs

Wave springs are precise flat wire compression springs that fit into assemblies that other springs cannot. Since the overall lengths and operating heights of wave springs are lower than those of conventional round wire springs, they will often reduce the size of an assembly by as much as 50%. Of course, this will also reduce the part weight and raw material cost of every spring produced.

Raw Material

As we meet the increasing demand for more raw material sizes, the flat wire rolling mill operation in our plant continues to grow. Years ago, Smalley began a vertical integration that has evolved into the production of hundreds of material cross-sections in a wide variety of alloys.



Our goal... to supply Smalley customers with uncompromising quality and service.

Manufacturing

Edgewinding, also known as “The No-Tooling-Cost Process”, is our precision forming operation that coils pre-tempered flat wire on edge to create a near-perfect circle. (Visualize a Slinky®, the coiled metal toy which has delighted generations of children.) Circular-Grain metallurgy gives our products strength and stability far superior to that of conventional retaining rings and wave washers which are simply stamped through the metal grain. Smalley edgewound products can be coiled to your exact specification in any diameter and with any number of turns (layers or coils), effectively eliminating material waste.

As flexible as it is precise, our edgewinding process accommodates your design changes without the need for additional tooling and die modifications. This facilitates your developmental work, allowing us to produce your low-quantity custom orders and your working prototypes quickly and economically. Even after your initial prototype is produced, or in mid-stream production, our edgewinding process allows us to alter your design or dimensions with simple machine adjustments or a change in raw material size. After the revised specifications are approved, we complete and document the final setup. Then, we quickly resume production of your order, whether it consists of one part or one million.



Edgewinding Process



Conventional Stamping Process

Prototypes

About the easiest way to test a theoretical design is to produce a working prototype — a task at which Smalley excels. A prime example is the development of a custom wave spring. We can adjust dimensions, by changing the number of waves and the number of turns, and trying different combinations of spring variables. Finally, we test for function, before production, so we know we have it right.

Smalley-produced prototypes are also the most economical way to provide results on a trial-and-error basis. From one to a thousand pieces, we can produce, try, modify, and reproduce your design as often as necessary — all without special tooling costs.

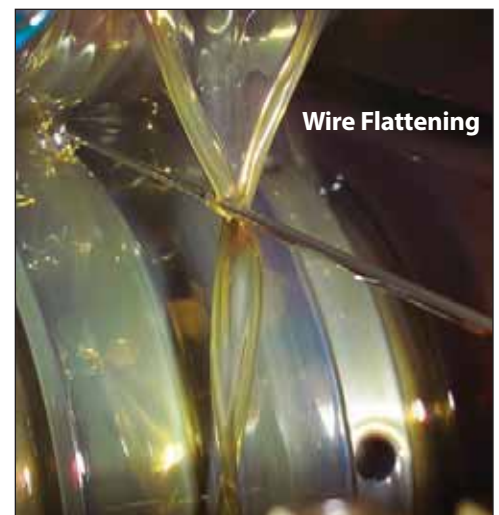

Finished Parts Warehouse

Smalley maintains a substantial parts inventory of every cataloged/standard retaining ring and wave spring — in both carbon and stainless steel. We do this to meet our JIT deliveries as well as any immediate requirement that you may have. In the rare circumstance that our inventory runs low, we can quickly replenish any item overnight.

In addition to our finished parts, we house a vast inventory of raw material sizes, stocked in thousands of pounds of flat wire. We are always ready to meet your needs for a quick turn-around in low to high quantities of existing or new designs.



Free

Need a Sample?

We offer free samples of any ring or spring found in our catalog. See page 138.

Customer Service

Smalley is dedicated to giving you the most positive, efficient and economical service possible, each and every day. We continually train our staff on every important aspect of our business. We can split shipments to suit your "just-in-time" delivery requirements. We offer you lower prices for your annual higher-usage orders. Please contact us directly for complete details and ideas on how you can purchase economically.

General Sales Information

Description:

The product descriptions in this catalog are intended to provide the user with practical information for application selection. Since it is not possible to include complete detail on all parts, please contact Smalley for any information not included in the description which may be critical for a specific application.

Quotations:

We will provide written or verbal quotations as requested.

Returns:

Parts not stocked which must be specially manufactured are not returnable except by special arrangement and will be subject to cancellation charges. Stocked parts may be returned for credit at a standard restocking charge (subject to condition). All returns of stocked parts must be made within 30 days from date of receipt of material.

Delivery:

Parts carried in stock normally will be shipped within 48 hours after receipt of an order. Special parts are normally delivered in 3 weeks (if no special processes are required) or as previously arranged.

Certifications:

Standard Certificate of Conformance will be supplied at no charge. Material and other Certifications for plating, load, etc. will be furnished as quoted.

Transportation:

As specified by the customer. In the absence of instructions, the shipping method will be selected by us. Insurance will be provided only at the customer's request.

Terms:

1/10/NET 30 on open accounts. For consideration of an open account, customers are requested to supply banking information and at least 3 commercial credit references.

Go to www.smalley.com for Terms and Conditions, which apply.

F.O.B.:

Factory, Lake Zurich, Illinois, USA

Packaging:

Rings and springs 34 mm in diameter and under are bulk packaged. Rings and springs 35 mm and over in diameter are generally tube (coin) packaged in lengths 250 mm to 450 mm.



Smalley is the proud recipient of the GM Quality Excellence Award and the GM Supplier of the Year Award.

Engineering & Design Assistance

Smalley's engineering staff is always ready to address your application requirements. Usually, the sooner we are able to review what you need, the easier the solution will be. Please call us today.

We invite you to draw upon our resources. Over the years, Smalley engineers have built an extensive library of over 25,000 applications while designing rings and springs in mechanical components and assemblies. In addition, we offer computer-aided spring-design alternatives to meet your specifications.

There are many more options that we would be pleased to review with you once your design criteria are established. We are ready to help you with the selection of a standard part from our vast inventory, or to modify a standard part to meet your exact needs.

We are pleased to offer you additional step-by-step resources. The "Special Designs" section of this catalog will help you determine basic retaining ring and wave spring specifications. We also invite you to try the design section on our website for step-by-step interactive design guidelines and options. As you can see, we are well-equipped to help you develop the best design solution possible, just as we have for thousands of other companies in diverse industries.

Specials

At Smalley, specials are standard. It's easy to get a custom part from Smalley. With No-Tooling-Charges, die costs, or other fixture charges, we can manufacture a new ring or spring design in just two weeks or to meet your delivery schedules.

Fast, precise, and economically — that's how Smalley produces rings and springs, in short runs or high volumes. If you can't find a standard part to meet your needs from the wide selection in our catalog, please contact our engineering department for immediate assistance with your special design requirements. And please note: Smalley Rings and Springs are available from 5 mm to 3000 mm in diameter.

CAD Downloads

Visit our website for CAD downloads in 90 different formats. It's easy to search and select a standard part for a quick upload to your computer.



Quality Policy

Smalley has established, and is continuously improving upon, a program that is designed to meet the following objectives:

- **Total product conformance in terms of drawings, specifications and contractual requirements.**
- **100% on-time delivery performance.**
- **Superior products with exceptional value.**
- **Prompt, professional and courteous response in every facet of design, manufacturing, sales, and customer service.**
- **Continued development and use of the latest technology.**

Quality Assurance

Smalley's Total Quality Management philosophy dictates our commitment to quality and customer satisfaction. While this commitment has earned us official certification (ISO 9001, ISO/TS 16949, AS 9100 and ISO 14001), quality assurance and customer satisfaction mean much more at Smalley. They are tradition; the very foundation upon which we have built our company. From the beginning, we have never lost sight of our goal: "to supply Smalley customers with uncompromising quality and service."

Smalley is committed to a quality policy that requires conformance to specification with controlled lot variation about the target, statistical quality control, defect prevention, and annual improvement in process and product. This is a company-wide commitment involving every Smalley employee. Each person works towards excellence, individually and cooperatively, to provide superior products and services.

A history of quality and strict compliance with military and aerospace standards has earned Smalley an approved supplier status with many leading original equipment manufacturers worldwide. Smalley has worked diligently to become their preferred source for Spirolox Retaining Rings and wave springs.

In accordance with the requirements of ISO 9001, ISO/TS 16949, AS 9100 and ISO 14001, we have established and are continuously improving our quality systems. Use of the latest technology, including statistical tools, has helped us achieve and maintain the world-class quality associated with the Smalley name for more than 50 years.

Smalley uses statistical quality control tools to assure the capability and stability of our coiling process. To begin with, we identify common dimensions to monitor and special causes of variation in the product. Then, we collect and analyze data on these critical dimensions. We perform disciplined sampling and take measurements during in-line and final inspection, and yet again, during pre-shipping inspection.

We make formal SQC in-house training programs mandatory for many Smalley employees involved with manufacturing.



This training has noticeably developed quality awareness and responsibility at all levels. Our employees have a clear understanding of what is expected, a means of regulating their processes and checking their output, and statistical tools to determine when machine adjustments are required.

Smalley's machine capability studies help us identify sources of variation before they become a problem. We analyze the capabilities of all production machinery in primary and secondary operations, heat treating, and finishing. In addition, we follow our own meticulous procedures to determine the reproducibility and repeatability of our gauging systems.

Due to the careful documentation of our quality, many Smalley customers have found that they can reduce or even eliminate their incoming inspections of our product. Many of our accounts have also revised their policy of dual sourcing and confidently rely on Smalley as their single source of Spirolox Retaining Rings, wave springs, constant section rings, linear springs and other wire forms.

Defect prevention, or near-zero defects, is a key goal at Smalley. We use the latest automated inspection techniques to monitor production. As a result, we are constantly studying the causes of variation, improving upon and developing processes with capability indexes (Cpk) exceeding 1.33.

Continuous improvement is an integral part of Smalley's quality plan. We require each of our departments to design and implement projects to improve their respective systems.

Wave Spring Introduction

All Springs Are Not Equal®

Smalley Wave Springs offer the unique advantage of space savings when used to replace coil springs. By reducing spring operating height, wave springs also produce a decrease in the spring cavity. With a smaller assembly size and less material used in the manufacturing process, a cost savings is realized.

Wave springs operate as load bearing devices. They take up play and compensate for dimensional variations within assemblies. A virtually unlimited range of forces can be produced whereby loads build either gradually or abruptly to reach a predetermined working height. This establishes a precise spring rate in which load is proportional to deflection.

Functional requirements are necessary for both dynamic and static spring applications. Special performance characteristics are individually built into each spring to satisfy a variety of precise operating conditions. Typically, a wave spring will occupy an extremely small area for the amount of work it performs. The use of this product is demanded, but not limited to tight axial and radial space constraints.

Product Performance

With their smooth, circular coiled sinusoidal wave form, and rolled round edges of pre-tempered raw material, Smalley's edgewound Wave Springs offer many advantages over die stamped products.

Loads and spring rates are more accurate, more predictable, and may be tolerated better than 50 percent tighter than stampings. The force of a Smalley Wave Spring will increase at a uniform rate throughout most of its available deflection.

By any criteria, Smalley Wave Springs offer their users higher dependability and better performance. Since they are produced from full hard, pre-tempered raw material, there is no risk of distorting the spring during a hardening heat treatment. By contrast, subsequent manufacturing procedures for stamped wavy washers can lead to problems such as fatigue cracking and inaccurate or inconsistent loading between springs. All told, the metallurgy, the mechanical properties and the uniform dimensional stability of the Smalley edgewound Wave Spring provide a component for precision quality applications.



Wave Spring Types



Gap Type Wave Spring



Overlap Type Wave Spring

Gap & Overlap Type

Conventional Gap and Overlap Type Wave Springs are used in a wide variety of applications. For short deflections and low-medium forces, they function with precision and dependability.

These two types of Smalley Wave Springs permit radial expansion or growth in diameter within a cavity, without the binding or hang-up normally associated with die stamped wave washers. Just as their terms imply, the gap type is split to retain a gap between the ends, while the overlap type has overlapping ends. Thus, the ends are free to move circumferentially as the spring outside diameter grows during compression.

For example, the O.D. of a Gap Type Wave Spring would fit 0,50 mm loose per side in a bore. Its I.D. clears a shaft by 0,25 mm per side. As the spring is deflected, the O.D. and I.D. grow larger until the O.D. contacts the bore. Continued deflection causes the gap ends to move closer together while the O.D. presses against the bore. An Overlap Type Wave Spring permits this type of cycling action in a similar manner.

Crest-to-Crest®

Crest-to-Crest Wave Springs are prestacked in series, decreasing the spring rate proportionally to the number of turns. Uses are typically applications requiring low-medium spring rates and large deflections with low-medium forces. Among major advantages, this design eliminates the need to keep the wave crests aligned. The need to use a key locating device, or to insert a shim between individual springs is not necessary. Because the spring is integrally formed, the wave peaks hold their configuration.

As a replacement for helical compression springs, Crest-to-Crest springs can develop similar forces, yet occupy one-half (½) or less the axial space. This allows for strict space constraints. Crest-to-Crest Wave Springs will maintain the same force and load specifications of a conventional round wire spring, but with the advantages of resultant lowered and compacted operating heights, free heights, and solid heights.



continued

Wave Spring Types (cont'd)



Crest-to-Crest with Optional Shim Ends

Crest-to-Crest Wave Springs are also available with squared-shim ends. Shim ends provide a 360° contact surface when compared to the wave point contact of plain ends. The shim ends, under load, more evenly distribute the spring's force upon adjacent components. This feature is similar to the concept of double-disc grinding springs for a flat surface. Shim ends have also been used to affix springs to mating components, as a flat locating surface that may be attached by various methods in the assembly.



Nested

Nested Wave Springs are pre-stacked in parallel from one continuous filament of flat wire. The need to stack individual springs for higher loads is no longer necessary. Nested springs result in a spring rate that increases proportionally to the number of turns. They can exert tremendous forces, yet maintain the precision of a circular-grain wave spring. In many applications, Nested Wave Springs replace Belleville Springs, particularly in cases where a high but accurate force is needed.



WAVO®

Wavo Springs are produced from round-section wire to provide higher loads while maintaining the accurate loading found in wave springs. As an alternative to Belleville Springs, the Wavo provides similar loads but with an accurate, predictable spring rate.

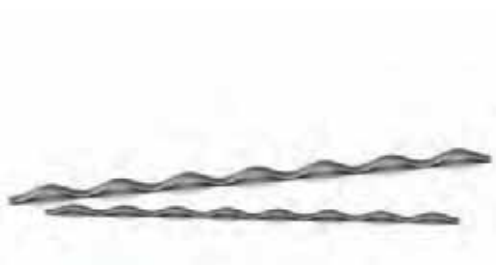

Linear Springs

Linear springs are a continuous wave formed (marcelled) wire length produce from spring tempered materials. They act as a load bearing device having approximately the same load/deflection characteristics as a wave spring.

Forces act linearly or radially depending on the installed position. Axial pressure is obtained by laying the spring flat in a straight line. Circular wrapping the spring produces a radial force or outward pressure. Linear springs are available cut to length or as a continuous coil, for the user to cut as needed.



A. Pressure Relief Valve



B. Face Seal

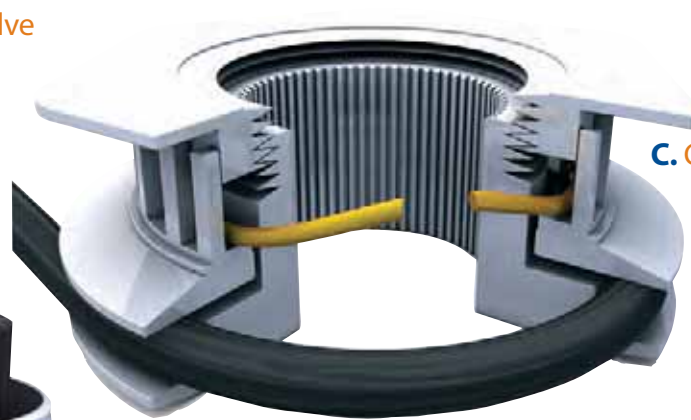

C. Clutch Drive



D. Bayonet Connector



E. Multi-Tooth Cutter

A. Pressure Relief Valve

An exact load applied to the top sealing plate was accomplished using a flat wire wave spring. Air pressure entering the top slots forces the plate away from the sealing surface providing the pressure relief mechanism.

B. Face Seal

Wave Spring applies pressure, to precisely load the carbon face against a mating surface, to properly seal fluids. The spring operates over a fixed working range and provides an exact force, unlike the stamped wavy washer it replaced which could not maintain the necessary spring rate.

C. Clutch Drive

Pressure on the round belt is produced by compressing the Wave Spring through the sheave halves. The top threaded cap rotates to adjust the Wave compression. The Wave can produce a high force in a tight radial cavity.

D. Bayonet Connector

Overlap Type Wave Spring installed in an electronic connector assembly. As male and female components are rotated together into final assembly, the wave spring is compressed to its working height. In this position it exerts a constant force that locks both components together.

E. Multi-Tooth Cutter

A custom designed wave spring with locating tabs is contained in the housing. The spring applies a precise force to the two cutter halves, allowing them to oscillate but not rattle.

Wave Spring Applications



F. Slip Clutch

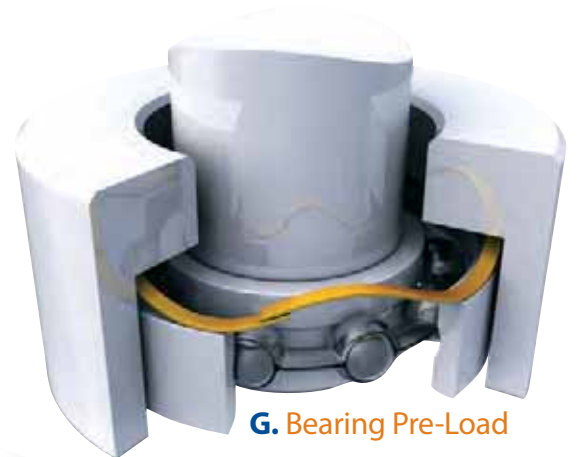

G. Bearing Pre-Load

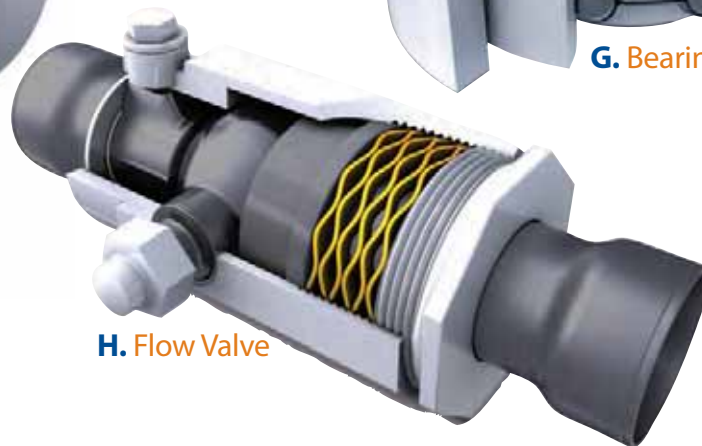

H. Flow Valve



I. Low Voltage Connector



J. Sprinkler Valve

F. Slip Clutch

Clutch drives when the “V”-detents are in the “V”-slots. A Smalley Wave Spring maintains pressure to hold this position. As torque is increased, the “V”-detents will ride up and out the “V”-slots, depressing the wave spring and developing the slip mechanism. When torque is decreased, the wave spring forces the “V”-detents firmly into the “V”-slots to drive again.

G. Bearing Pre-Load

One of the most common wave spring applications world-wide is a bearing preload arrangement as illustrated. Having the proper load will often extend bearing life by lowering operating temperatures, reducing vibration, minimizing wear and providing for quieter and smoother performance.

H. Flow Valve

As fluid pressure increases the Crest-to-Crest Wave Spring precisely controls the linear displacement of the piston, which positions the orifice for proper fluid flow. Because of the space savings of the Crest-to-Crest design, the valve can be made smaller.

I. Low Voltage Connector

A Bayonet Connector couples as the male end rotates and follows the groove contour in the female end. A 2-Turn Nested Spirawave Wave Spring provides the pre-load between the two halves. A 2-Turn Nested Spring was necessary to develop a higher load in very tight radial and axial space.

J. Sprinkler Valve

With height restrictions accounted for, the Smalley Crest-to-Crest Wave Spring maintains constant pressure on the pop-up head, holding it firmly closed. In operation, water pressure releases the head by overcoming the spring's force.



K. Oil Valve



L. Ball Valve



M. Quick Disconnect



N. Vibration Isolator

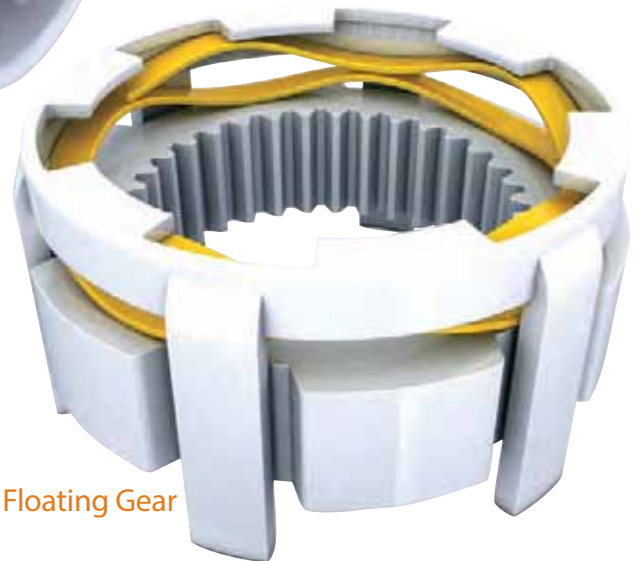

O. Floating Gear

K. Oil Valve

The force provided by the Crest-to-Crest Wave Spring in this oil valve application precisely regulates the amount of oil that is released. The Crest-to-Crest spring provides accurate resistance in a small space, allowing the overall size of the valve to be greatly reduced.

L. Ball Valve

A Smalley Crest-to-Crest Wave Spring is used to reduce the overall spring height in this application. The wave spring allows the seat to oscillate on the ball, keeping a tight seal in the operating position. The reduction in spring height and resulting smaller spring cavity also reduce the weight of the valve.

M. Quick Disconnect

The sliding member of the disconnect is held in its forward/locked position against the retaining ring, by the Crest-to-Crest Spring. As the user slides the member in the opposite direction compressing the spring, the detent balls align with a groove and release.

N. Vibration Isolator

Wavo Springs provide high force and a relatively large axial displacement, in limited space. The springs are arranged in series for additional travel.

O. Floating Gear

Functioning in a contained bracket, a Crest-to-Crest Wave Spring loads a gear with light force allowing axial movement. The gear shown self-aligns with its mating gear during operation.



Smalley Circular-Grain bearing preload Wave Springs eliminate play and minimize bearing noise. The constant light/medium pressure they apply removes play between the ball bearings and the bearings' inner and outer races. Preloading can reduce the possibility of bearing damage due to vibration (vibratory loading) and wear due to repetitive and non-repetitive runout.

Stock Items in carbon steel and 17-7 PH stainless steel. Springs listed below are 3 and 4 waves **Overlap Type**.

Smalley Part Number ^{1,5}	Bearing O.D. ²	Clears Shaft Diameter	Load (N)	Work Height	Free Height ³	Number of Waves	Thickness	Radial Wall	Spring Rate ⁴
SSB-0063	16,00	11,28	44,5	1,57	2,29	3	0,25	1,98	65
SSB-0075	19,00	14,28	53,4	1,57	3,05	3	0,25	1,98	35
SSB-0087	22,00	16,46	62,3	1,57	2,79	3	0,30	2,39	48
SSB-0095	24,00	18,46	66,7	1,57	3,56	3	0,30	2,39	35
SSB-0102	26,00	18,22	71,2	1,98	2,54	3	0,41	3,38	111
SSB-0110	28,00	20,22	75,6	1,98	2,79	3	0,41	3,38	85
SSB-0118	30,00	22,22	84,5	1,98	3,30	3	0,41	3,38	66
SSB-0126	32,00	24,22	89,0	1,98	3,81	3	0,41	3,38	52
SSB-0138	35,00	27,22	97,9	1,98	4,57	3	0,41	3,38	38
SSB-0146	37,00	28,72	102,3	1,98	3,81	3	0,46	3,63	58
SSB-0158	40,00	31,72	111,2	1,98	5,08	3	0,46	3,63	37
SSB-0165	42,00	33,72	115,7	1,98	3,05	4	0,46	3,63	99
SSB-0185	47,00	38,72	129,0	1,98	3,81	4	0,46	3,63	68
SSB-0205	52,00	43,11	142,4	2,36	3,56	4	0,61	3,76	121
SSB-0217	55,00	46,11	151,3	2,36	3,81	4	0,61	3,76	100
SSB-0244	62,00	51,69	169,1	2,36	4,32	4	0,61	4,52	85
SSB-0268	68,00	57,17	186,9	2,77	4,32	4	0,76	4,78	131
SSB-0276	70,00	59,17	191,3	2,77	4,32	4	0,76	4,78	119
SSB-0284	72,00	61,17	195,8	2,77	4,57	4	0,76	4,78	108
SSB-0295	75,00	64,17	204,7	2,77	5,08	4	0,76	4,78	94
SSB-0315	80,00	68,66	218,0	2,77	5,59	4	0,76	4,78	76
SSB-0335	85,00	71,38	231,4	2,77	5,59	4	0,76	5,92	83
SSB-0354	90,00	76,38	249,2	2,77	6,35	4	0,76	5,92	68
SSB-0374	95,00	81,38	262,5	2,77	7,37	4	0,76	5,92	57

OVERLAP TYPE SSB-0063 to SSB-0374

Product Dimensions

All dimensions in millimeters unless otherwise specified.

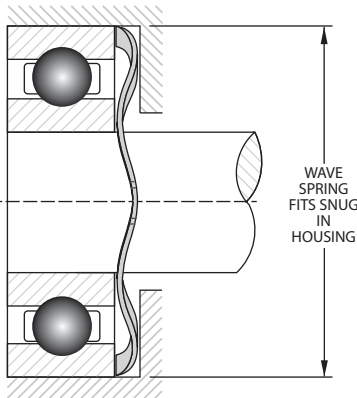

MULTI-WAVE
(SEE TABLE)

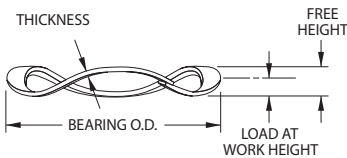
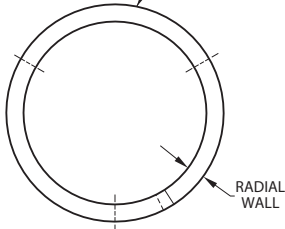

¹ Add suffix "-S17" for 17-7 stainless steel.

² Wave springs fit snug in housing.

³ Reference dimension.

⁴ Theoretical dimension; measured in N/mm.

⁵ See pages 134-135 for How to Order.



Bearing Assembly

Stock Items in carbon steel and 17-7 PH stainless steel. Springs listed below are 5 waves and up, **Gap Type**.

Smalley Part Number ^{1,5}	Bearing O.D. ²	Clears Shaft Diameter	Load (N)	Work Height	Free Height ³	Number of Waves	Thickness	Radial Wall	Spring Rate ⁴
SSB-0394	100,00	86,38	275,9	2,77	4,57	5	0,76	5,92	157
SSB-0413	105,00	91,38	289,2	2,77	5,08	5	0,76	5,92	134
SSB-0433	110,00	96,38	302,6	2,77	5,33	5	0,76	5,92	115
SSB-0453	115,00	101,38	315,9	3,18	6,35	5	0,76	5,92	99
SSB-0472	120,00	106,38	329,3	3,18	7,11	5	0,76	5,92	86
SSB-0492	125,00	111,38	342,6	3,18	7,62	5	0,76	5,92	76
SSB-0512	130,00	116,38	356,0	3,18	8,64	5	0,76	5,92	67
SSB-0532	135,00	121,38	369,3	3,18	9,40	5	0,76	5,92	59
SSB-0551	140,00	126,38	382,7	3,18	6,86	6	0,76	5,92	108
SSB-0571	145,00	131,38	396,0	3,18	7,37	6	0,76	5,92	97
SSB-0591	150,00	136,38	404,9	3,18	7,87	6	0,76	5,92	87
SSB-0630	160,00	146,38	440,5	3,18	9,40	6	0,76	5,92	71
SSB-0650	165,00	151,38	453,9	3,18	10,41	6	0,76	5,92	64
SSB-0669	170,00	156,38	467,2	3,18	11,18	6	0,76	5,92	58
SSB-0689	175,00	154,16	480,6	3,96	8,13	6	0,81	9,53	116
SSB-0709	180,00	159,16	493,9	3,96	8,64	6	0,81	9,53	105
SSB-0728	185,00	164,16	507,3	3,96	9,14	6	0,81	9,53	97
SSB-0748	190,00	169,16	520,6	3,96	9,91	6	0,81	9,53	88
SSB-0787	200,00	179,16	547,3	3,96	7,11	7	0,81	9,53	174
SSB-0807	205,00	184,16	560,7	3,96	7,37	7	0,81	9,53	161
SSB-0827	210,00	189,16	578,5	3,96	7,87	7	0,81	9,53	149
SSB-0847	215,00	194,16	591,8	3,96	8,38	7	0,81	9,53	138
SSB-0866	220,00	199,16	605,2	3,96	8,64	7	0,81	9,53	128
SSB-0886	225,00	204,16	618,5	3,96	7,11	8	0,81	9,53	203
SSB-0906	230,00	209,16	631,9	3,96	6,10	9	0,81	9,53	303
SSB-0925	235,00	214,16	645,2	3,96	6,35	9	0,81	9,53	283
SSB-0945	240,00	219,16	658,6	3,96	6,35	9	0,81	9,53	265
SSB-0984	250,00	229,16	685,3	3,96	6,86	9	0,81	9,53	232
SSB-1024	260,00	239,16	712,0	3,96	7,37	9	0,81	9,53	205
SSB-1043	265,00	244,16	725,3	3,96	7,62	9	0,81	9,53	193
SSB-1063	270,00	249,16	743,1	3,96	8,13	9	0,81	9,53	182
SSB-1102	280,00	259,16	769,8	3,96	8,64	9	0,81	9,53	162
SSB-1142	290,00	269,16	796,5	3,96	9,40	9	0,81	9,53	144
SSB-1181	300,00	279,16	823,2	3,96	10,41	9	0,81	9,53	129
SSB-1221	310,00	289,16	849,9	3,96	7,11	9	1,07	9,53	264
SSB-1260	320,00	299,16	876,6	3,96	7,62	9	1,07	9,53	239
SSB-1339	340,00	319,16	934,5	3,96	8,64	9	1,07	9,53	198
SSB-1378	350,00	329,16	961,1	3,96	9,40	9	1,07	9,53	180
SSB-1417	360,00	339,16	987,9	3,96	7,62	10	1,07	9,53	271
SSB-1457	370,00	349,16	1014,6	3,96	8,13	10	1,07	9,53	249
SSB-1496	380,00	359,16	1041,3	3,96	8,64	10	1,07	9,53	229
SSB-1535	390,00	369,16	1072,4	3,96	9,14	10	1,07	9,53	211
SSB-1575	400,00	379,16	1099,1	3,96	9,65	10	1,07	9,53	196
SSB-1614	410,00	382,82	1125,8	3,96	8,38	10	1,07	12,70	251
SSB-1654	420,00	392,82	1152,5	3,96	8,89	10	1,07	12,70	233
SSB-1693	430,00	402,82	1179,2	3,96	7,62	11	1,07	12,70	317
SSB-1732	440,00	412,82	1205,9	3,96	8,13	11	1,07	12,70	295
SSB-1811	460,00	432,82	1263,7	3,96	8,89	11	1,07	12,70	256
SSB-1890	480,00	452,82	1317,1	3,96	8,13	12	1,07	12,70	318
SSB-1969	500,00	472,82	1370,5	3,96	8,89	12	1,07	12,70	280
SSB-2126	540,00	512,82	1481,8	3,96	8,89	13	1,07	12,70	303
SSB-2284	580,00	552,82	1593,0	3,96	8,89	14	1,07	12,70	327

¹ Add suffix "-S17" for 17-7 stainless steel.

² Wave springs fit snug in housing.

³ Reference dimension.

⁴ Theoretical dimension; measured in N/mm.

⁵ See pages 134-135 for How to Order.



GAP TYPE SSB-0394 to SSB-2284

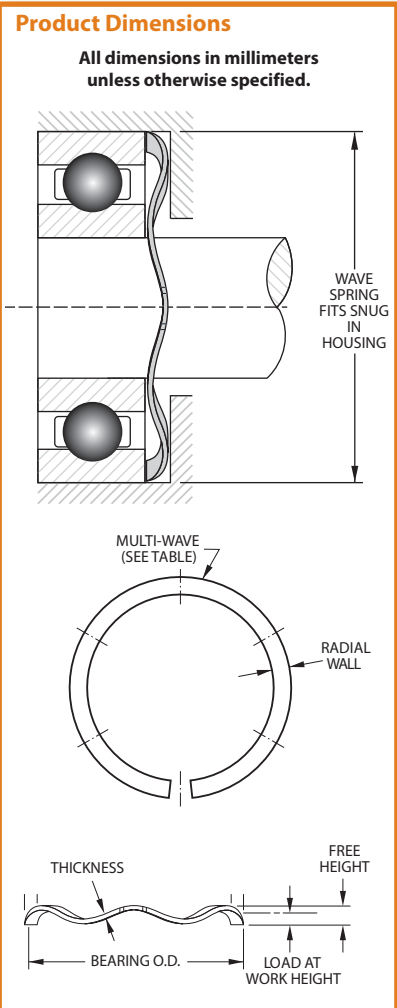



Use this cross-reference guide to select the appropriate Wave Spring for your bearing size. The numbers represent typical standard bearing part numbers and/or the suffix of a standard bearing size.

Stock Items in carbon steel and 17-7 PH stainless steel.

Smalley Part Number ^{1,4}	Bearing O.D. ²	Bearing Part Numbers						
		Extra Small	Extremely Light	Extra Light	Narrow	Light	Medium	Heavy
SSB-0063	16,00	34	—	—	—	—	—	—
SSB-0075	19,00	35, 36	—	—	—	—	—	—
SSB-0087	22,00	37, 38	00	—	—	—	—	—
SSB-0095	24,00	38KV	01	—	—	—	—	—
SSB-0102	26,00	39	—	100	—	—	—	—
SSB-0110	28,00	—	02	101	—	—	—	—
SSB-0118	30,00	—	03	—	—	200	—	—
SSB-0126	32,00	—	—	102	02	201	—	—
SSB-0138	35,00	—	—	103	—	202	300	—
SSB-0146	37,00	—	04	—	03	—	301	—
SSB-0158	40,00	—	—	—	—	203	—	—
SSB-0165	42,00	—	05	104	04	—	302	—
SSB-0185	47,00	—	06	105	—	204	303	—
SSB-0205	52,00	—	—	—	05	205	304	—
SSB-0217	55,00	—	07	106	—	—	—	—
SSB-0244	62,00	—	08	107	06	206	305	403
SSB-0268	68,00	—	09	108	—	—	—	—
SSB-0276	70,00	—	—	—	07	—	—	—
SSB-0284	72,00	—	10	—	—	207	306	404
SSB-0295	75,00	—	—	109	—	—	—	—
SSB-0315	80,00	—	11	110	08	208	307	405
SSB-0335	85,00	—	12	—	09	209	—	—
SSB-0354	90,00	—	13	111	10	210	308	406
SSB-0374	95,00	—	—	112	—	—	—	—
SSB-0394	100,00	—	14	113	11	211	309	407
SSB-0413	105,00	—	15	—	12	—	—	—
SSB-0433	110,00	—	16	114	—	212	310	408
SSB-0453	115,00	—	—	115	13	—	—	—
SSB-0472	120,00	—	17	—	14	213	311	409
SSB-0492	125,00	—	18	116	—	214	—	—
SSB-0512	130,00	—	19	117	15	215	312	410
SSB-0532	135,00	—	—	—	16	—	—	—
SSB-0551	140,00	—	20	118	—	216	313	411
SSB-0571	145,00	—	21	119	17	—	—	—
SSB-0591	150,00	—	22	120	18	217	314	412
SSB-0630	160,00	—	—	121	19	218	315	413
SSB-0650	165,00	—	24	—	20	—	—	—
SSB-0669	170,00	—	—	122	—	219	316	—
SSB-0689	175,00	—	—	—	22 ³	—	—	—
SSB-0709	180,00	—	26	124	21	220	317	414
SSB-0728	185,00	—	—	—	22 ³	—	—	—
SSB-0748	190,00	—	28	—	24	221	318	415
SSB-0787	200,00	—	—	126	—	222	319	416
SSB-0807	205,00	—	—	—	26	—	—	—
SSB-0827	210,00	—	30	128	—	—	—	417
SSB-0847	215,00	—	—	—	—	224	320	—

¹ Add suffix "-S17" for 17-7 stainless steel.

² Wave springs fit snug in housing.

³ Check bearing dimensions.

⁴ See pages 134-135 for How to Order.

Use this cross-reference guide to select the appropriate Wave Spring for your bearing size. The numbers represent typical standard bearing part numbers and/or the suffix of a standard bearing size.

Stock Items in carbon steel and 17-7 PH stainless steel.

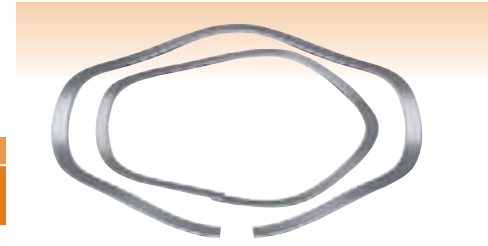

Smalley Part Number ^{1,4}	Bearing O.D. ²	Bearing Part Numbers						
		Extra Small	Extremely Light	Extra Light	Narrow	Light	Medium	Heavy
SSB-0866	220,00	—	32	—	28	—	—	—
SSB-0886	225,00	—	—	130	—	—	321	418
SSB-0906	230,00	—	34	—	—	226	—	—
SSB-0925	235,00	—	—	—	30	—	—	—
SSB-0945	240,00	—	—	132	—	—	322	—
SSB-0984	250,00	—	36	—	32	228	—	419
SSB-1024	260,00	—	38	134	—	—	324	—
SSB-1043	265,00	—	—	—	34	—	—	420
SSB-1063	270,00	—	—	—	—	230	—	—
SSB-1102	280,00	—	40	136	36	—	326	—
SSB-1142	290,00	—	—	138	—	232	—	421
SSB-1181	300,00	—	—	—	38	—	328	—
SSB-1221	310,00	—	—	140	—	234	—	—
SSB-1260	320,00	—	—	—	40	236	330	422
SSB-1339	340,00	—	—	144	42	238	332	—
SSB-1378	350,00	—	—	—	44	—	—	—
SSB-1417	360,00	—	—	148	—	240	334	—
SSB-1457	370,00	—	—	—	46	—	—	—
SSB-1496	380,00	—	—	—	—	—	336	—
SSB-1535	390,00	—	—	—	48	—	—	—
SSB-1575	400,00	—	—	152	—	244	338	—
SSB-1614	410,00	—	—	—	50	—	—	—
SSB-1654	420,00	—	—	156	—	—	340	—
SSB-1693	430,00	—	—	—	52	—	—	—
SSB-1732	440,00	—	—	—	—	248	342	—
SSB-1811	460,00	—	—	160	56	—	344	—
SSB-1890	480,00	—	—	164	—	252	—	—
SSB-1969	500,00	—	—	—	64	256	348	—
SSB-2126	540,00	—	—	—	—	260	352	—
SSB-2284	580,00	—	—	—	—	264	356	—

¹ Add suffix "-S17" for 17-7 stainless steel.

² Wave springs fit snug in housing.

³ Check bearing dimensions.

⁴ See pages 134-135 for How to Order.

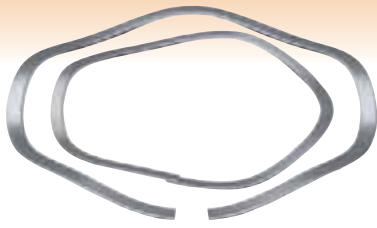

Stock Items in carbon steel and 17-7 PH stainless steel. Springs listed below are 3 wave, **Overlap Type**.

Smalley Part Number ^{1,4}	Operates in Bore Diameter	Clears Shaft Diameter	Load (lb)	Work Height	Free Height ²	Number of Waves	Thickness	Radial Wall	Spring Rate ³
SSR-0050	0,500	0,390	7	0,050	0,085	3	0,008	0,040	200
SSR-0062	0,625	0,480	10	0,050	0,095	3	0,010	0,058	222
SSR-0075	0,750	0,500	14	0,062	0,160	3	0,010	0,078	143
SSR-0087	0,875	0,620	16	0,062	0,130	3	0,012	0,094	235
SSR-0100	1,000	0,780	18	0,062	0,160	3	0,012	0,094	184
SSR-0112	1,125	0,840	20	0,078	0,130	3	0,016	0,133	385
SSR-0125	1,250	0,960	22	0,078	0,150	3	0,016	0,133	306
SSR-0137	1,375	1,090	24	0,078	0,190	3	0,016	0,133	214
SSR-0150	1,500	1,170	26	0,078	0,170	3	0,018	0,143	283
SSR-0162	1,625	1,310	28	0,078	0,200	3	0,018	0,143	230

¹ Add suffix "-S17" for 17-7 stainless steel.

² Reference dimension.

³ Theoretical dimension; measured in lb/in.

⁴ See pages 134-135 for How to Order.

⁵ 1 lb = 4,448 N

1 inch = 25,4 mm

OVERLAP TYPE

SSR-0050 to SSR-0162

Product Dimensions

All dimensions in inches unless otherwise specified.

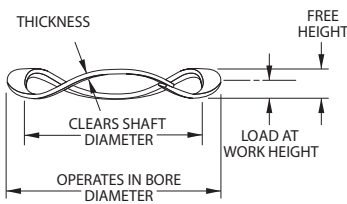
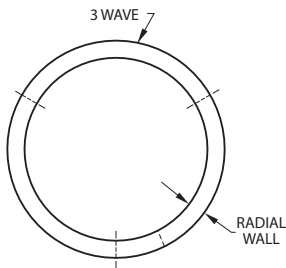

Bayonet Connector

Stock Items in carbon steel and 17-7 PH stainless steel. Springs listed below are 4 waves and up, **Gap Type**.

Smalley Part Number ^{1,4}	Operates in Bore Diameter	Clears Shaft Diameter	Load (lb)	Work Height	Free Height ²	Number of Waves	Thickness	Radial Wall	Spring Rate ³
SSR-0175	1,750	1,440	30	0,078	0,140	4	0,018	0,143	484
SSR-0187	1,875	1,560	32	0,078	0,150	4	0,018	0,143	444
SSR-0200	2,000	1,680	34	0,093	0,140	4	0,024	0,150	723
SSR-0212	2,125	1,800	36	0,093	0,150	4	0,024	0,150	632
SSR-0225	2,250	1,930	38	0,093	0,170	4	0,024	0,150	494
SSR-0237	2,375	1,990	40	0,093	0,160	4	0,024	0,178	597
SSR-0250	2,500	2,120	42	0,093	0,170	4	0,024	0,178	545
SSR-0262	2,625	2,240	44	0,093	0,190	4	0,024	0,178	454
SSR-0275	2,750	2,340	46	0,109	0,170	4	0,030	0,188	754
SSR-0287	2,875	2,470	48	0,109	0,180	4	0,030	0,188	676
SSR-0300	3,000	2,590	50	0,109	0,190	4	0,030	0,188	617
SSR-0312	3,125	2,710	52	0,109	0,210	4	0,030	0,188	515
SSR-0325	3,250	2,750	54	0,109	0,200	4	0,030	0,233	593
SSR-0337	3,375	2,840	56	0,109	0,220	4	0,030	0,233	505
SSR-0350	3,500	3,000	58	0,109	0,230	4	0,030	0,233	479
SSR-0362	3,625	3,120	60	0,109	0,240	4	0,030	0,233	458
SSR-0375	3,750	3,250	62	0,109	0,260	4	0,030	0,233	411
SSR-0387	3,875	3,370	64	0,109	0,300	4	0,030	0,233	335
SSR-0400	4,000	3,500	66	0,109	0,190	5	0,030	0,233	815
SSR-0412	4,125	3,620	67	0,109	0,200	5	0,030	0,233	736
SSR-0425	4,250	3,740	69	0,109	0,210	5	0,030	0,233	683
SSR-0437	4,375	3,860	70	0,109	0,210	5	0,030	0,233	693
SSR-0450	4,500	3,990	72	0,109	0,230	5	0,030	0,233	595
SSR-0462	4,625	4,110	73	0,125	0,270	5	0,030	0,233	503
SSR-0475	4,750	4,240	75	0,125	0,310	5	0,030	0,233	405
SSR-0487	4,875	4,370	76	0,125	0,290	5	0,030	0,233	461
SSR-0500	5,000	4,490	78	0,125	0,310	5	0,030	0,233	422
SSR-0512	5,125	4,610	80	0,125	0,340	5	0,030	0,233	372
SSR-0525	5,250	4,740	82	0,125	0,370	5	0,030	0,233	335
SSR-0537	5,375	4,860	84	0,125	0,380	5	0,030	0,233	329
SSR-0550	5,500	4,990	86	0,125	0,250	6	0,030	0,233	688
SSR-0562	5,625	5,110	88	0,125	0,270	6	0,030	0,233	607
SSR-0575	5,750	5,240	90	0,125	0,280	6	0,030	0,233	581
SSR-0587	5,875	5,360	92	0,125	0,300	6	0,030	0,233	526
SSR-0600	6,000	5,490	94	0,125	0,300	6	0,030	0,233	537
SSR-0612	6,125	5,610	96	0,125	0,310	6	0,030	0,233	519
SSR-0625	6,250	5,730	98	0,125	0,340	6	0,030	0,233	456
SSR-0637	6,375	5,860	100	0,125	0,350	6	0,030	0,233	444
SSR-0650	6,500	5,980	102	0,125	0,390	6	0,030	0,233	385
SSR-0675	6,750	6,230	104	0,125	0,420	6	0,030	0,233	353
SSR-0700	7,000	6,160	106	0,156	0,320	6	0,032	0,375	646
SSR-0725	7,250	6,440	108	0,156	0,350	6	0,032	0,375	557
SSR-0750	7,500	6,690	110	0,156	0,360	6	0,032	0,375	539
SSR-0775	7,750	6,940	114	0,156	0,380	6	0,032	0,375	509
SSR-0800	8,000	7,190	118	0,156	0,390	6	0,032	0,375	504
SSR-0825	8,250	7,440	122	0,156	0,430	6	0,032	0,375	445
SSR-0850	8,500	7,680	126	0,156	0,340	7	0,032	0,375	685
SSR-0875	8,750	7,930	130	0,156	0,340	7	0,032	0,375	707
SSR-0900	9,000	8,180	134	0,156	0,290	8	0,032	0,375	1000
SSR-0950	9,500	8,680	142	0,156	0,240	9	0,032	0,375	1690
SSR-1000	10,000	9,170	150	0,156	0,290	9	0,032	0,375	1119
SSR-1050	10,500	9,670	158	0,156	0,310	9	0,032	0,375	1026
SSR-1100	11,000	10,170	166	0,156	0,350	9	0,032	0,375	856
SSR-1150	11,500	10,660	174	0,156	0,360	9	0,032	0,375	853
SSR-1200	12,000	11,160	182	0,156	0,440	9	0,032	0,375	641
SSR-1250	12,500	11,660	190	0,156	0,350	10	0,032	0,375	979
SSR-1300	13,000	12,160	198	0,156	0,410	10	0,032	0,375	780
SSR-1350	13,500	12,650	206	0,156	0,430	10	0,032	0,375	752
SSR-1400	14,000	13,150	214	0,156	0,300	12	0,032	0,375	1486
SSR-1450	14,500	13,650	221	0,156	0,320	12	0,032	0,375	1348
SSR-1500	15,000	14,130	230	0,156	0,350	12	0,032	0,375	1186
SSR-1550	15,500	14,640	239	0,156	0,310	13	0,032	0,375	1552
SSR-1600	16,000	15,140	248	0,156	0,340	13	0,032	0,375	1348

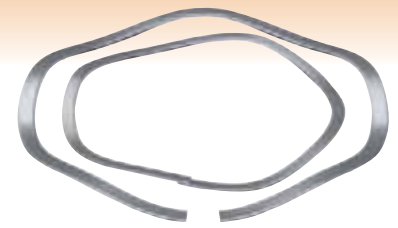

GAP TYPE

SSR-0175 to SSR-1600

Product Dimensions

All dimensions in inches unless otherwise specified.

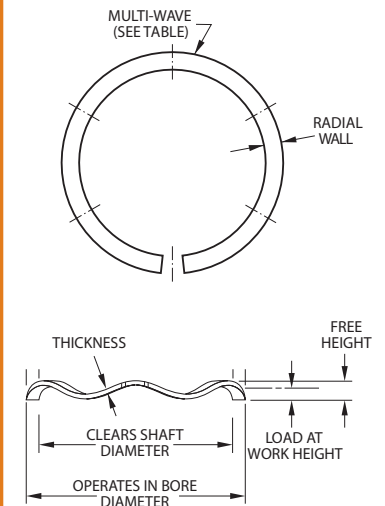

¹ Add suffix "-S17" for 17-7 stainless steel.

² Reference dimension.

³ Theoretical dimension; measured in lb/in.

⁴ See pages 134-135 for How to Order.

⁵ 1 lb = 4,448 N

1 inch = 25,4 mm

SSR-N Series IMPERIAL Narrow Section Wave Springs

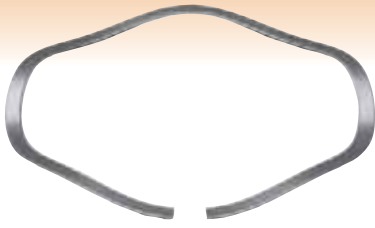

Smalley narrow section wave springs were originally designed to pre-load packings in telescoping hydraulic cylinders. They have also found other applications where working space is highly limited. This Smalley Wave Spring series is designed to fit into a bore with a light snap to assure perfect concentricity between the wave spring and assembly. When these narrow section wave springs are compressed, radial expansion is taken up by the gap in the spring to eliminate binding.

Stock Items in carbon steel and 17-7 PH stainless steel. Springs listed below are 4 waves and up, **Gap Type**.

Smalley Part Number ^{1,4}	Operates in Bore Diameter	Clears Shaft Diameter	Load (lb)	Work Height	Free Height ²	Number of Waves	Thickness	Radial Wall	Spring Rate ³
SSR-0325-N	3,250	2,820	54	0,109	0,200	4	0,030	0,188	593
SSR-0337-N	3,375	2,940	56	0,109	0,220	4	0,030	0,188	505
SSR-0350-N	3,500	3,070	58	0,109	0,260	4	0,030	0,188	384
SSR-0362-N	3,625	3,190	60	0,109	0,270	4	0,030	0,188	373
SSR-0375-N	3,750	3,320	62	0,109	0,280	4	0,030	0,188	363
SSR-0387-N	3,875	3,440	64	0,109	0,310	4	0,030	0,188	318
SSR-0400-N	4,000	3,570	66	0,109	0,200	5	0,030	0,188	725
SSR-0412-N	4,125	3,690	67	0,109	0,200	5	0,030	0,188	736
SSR-0425-N	4,250	3,820	69	0,109	0,240	5	0,030	0,188	527
SSR-0437-N	4,375	3,940	70	0,109	0,210	5	0,030	0,188	693
SSR-0450-N	4,500	4,070	72	0,109	0,280	5	0,030	0,188	421
SSR-0462-N	4,625	4,190	73	0,125	0,270	5	0,030	0,188	503
SSR-0475-N	4,750	4,320	75	0,125	0,320	5	0,030	0,188	385
SSR-0487-N	4,875	4,440	76	0,125	0,320	5	0,030	0,188	390
SSR-0500-N	5,000	4,570	78	0,125	0,350	5	0,030	0,188	347
SSR-0512-N	5,125	4,690	80	0,125	0,350	5	0,030	0,188	356
SSR-0525-N	5,250	4,820	82	0,125	0,360	5	0,030	0,188	349
SSR-0537-N	5,375	4,940	84	0,125	0,440	5	0,030	0,188	267
SSR-0550-N	5,500	5,070	86	0,125	0,280	6	0,030	0,188	555
SSR-0562-N	5,625	5,190	88	0,125	0,290	6	0,030	0,188	533
SSR-0575-N	5,750	5,320	90	0,125	0,340	6	0,030	0,188	419
SSR-0587-N	5,875	5,440	92	0,125	0,340	6	0,030	0,188	428
SSR-0600-N	6,000	5,570	94	0,125	0,340	6	0,030	0,188	437
SSR-0612-N	6,125	5,690	96	0,125	0,280	7	0,030	0,188	619
SSR-0625-N	6,250	5,820	98	0,125	0,280	7	0,030	0,188	632
SSR-0637-N	6,375	5,940	100	0,125	0,300	7	0,030	0,188	571
SSR-0650-N	6,500	6,070	102	0,125	0,300	7	0,030	0,188	583
SSR-0675-N	6,750	6,320	104	0,125	0,300	7	0,030	0,188	594
SSR-0700-N	7,000	6,480	106	0,156	0,320	7	0,030	0,233	646
SSR-0725-N	7,250	6,730	108	0,156	0,330	7	0,030	0,233	621
SSR-0750-N	7,500	6,980	110	0,156	0,360	7	0,030	0,233	539
SSR-0775-N	7,750	7,230	114	0,156	0,380	7	0,030	0,233	509

GAP TYPE

SSR-0325-N to SSR-0775-N

Product Dimensions

All dimensions in inches unless otherwise specified.

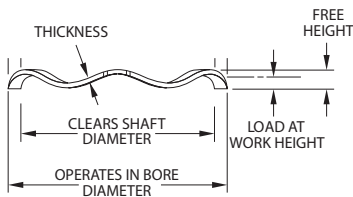
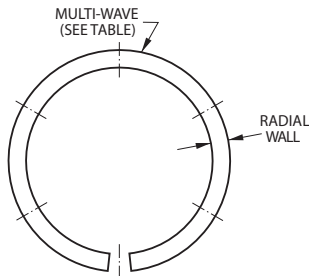

¹ Add suffix "-S17" for 17-7 stainless steel.

² Reference dimension.

³ Theoretical dimension; measured in lb/in.

⁴ See pages 134-135 for How to Order.

⁵ 1 lb = 4,448 N

1 inch = 25,4 mm

Stock Items in carbon and 17-7 PH stainless steel.

Smalley Part Number ^{1,4}	Operates in Bore Diameter	Clears Shaft Diameter	Load (lb)	Work Height	Free Height ²	Number of Waves	Wire Diameter	Spring Rate ³
RW-0050	0,500	0,408	35	0,052	0,062	3	0,031	3500
RW-0062	0,625	0,517	50	0,064	0,077	3	0,038	3846
RW-0075	0,750	0,628	70	0,076	0,092	3	0,045	4375
RW-0087	0,875	0,740	80	0,086	0,104	3	0,051	4444
RW-0100	1,000	0,855	90	0,095	0,116	3	0,056	4286
RW-0112	1,125	0,967	100	0,102	0,127	3	0,060	4000
RW-0125	1,250	1,081	110	0,110	0,138	3	0,065	3929
RW-0137	1,375	1,223	120	0,095	0,121	4	0,056	4615
RW-0150	1,500	1,339	130	0,102	0,128	4	0,060	5000
RW-0162	1,625	1,444	140	0,110	0,137	4	0,065	5185
RW-0175	1,750	1,564	150	0,113	0,144	4	0,067	4839
RW-0187	1,875	1,682	160	0,119	0,155	4	0,070	4444
RW-0200	2,000	1,803	170	0,124	0,165	4	0,072	4146
RW-0212	2,125	1,906	180	0,129	0,162	4	0,076	5455
RW-0225	2,250	2,023	190	0,136	0,168	4	0,080	5938
RW-0237	2,375	2,141	200	0,141	0,178	4	0,083	5405
RW-0250	2,500	2,261	210	0,144	0,185	4	0,085	5122
RW-0262	2,625	2,374	220	0,153	0,203	4	0,090	4400
RW-0275	2,750	2,497	230	0,154	0,212	4	0,091	3966
RW-0287	2,875	2,618	240	0,158	0,210	4	0,093	4615
RW-0300	3,000	2,767	250	0,141	0,179	5	0,083	6579
RW-0312	3,125	2,878	260	0,144	0,184	5	0,085	6500
RW-0325	3,250	2,992	270	0,153	0,190	5	0,090	7297
RW-0337	3,375	3,115	280	0,154	0,195	5	0,091	6829
RW-0350	3,500	3,236	290	0,158	0,201	5	0,093	6744
RW-0362	3,625	3,356	300	0,161	0,206	5	0,095	6667
RW-0375	3,750	3,475	310	0,166	0,212	5	0,098	6739
RW-0387	3,875	3,595	320	0,170	0,208	5	0,100	8421
RW-0400	4,000	3,718	330	0,170	0,225	5	0,100	6000
RW-0412	4,125	3,827	335	0,175	0,221	5	0,105	7283
RW-0425	4,250	3,948	345	0,178	0,225	5	0,105	7340
RW-0437	4,375	4,063	350	0,187	0,240	5	0,110	6604
RW-0450	4,500	4,185	360	0,187	0,247	5	0,110	6000
RW-0462	4,625	4,310	365	0,187	0,253	5	0,110	5530
RW-0475	4,750	4,431	375	0,190	0,257	5	0,112	5597
RW-0487	4,875	4,555	380	0,190	0,264	5	0,112	5135
RW-0500	5,000	4,672	390	0,195	0,265	5	0,116	5571
RW-0512	5,125	4,772	400	0,200	0,274	5	0,118	5405
RW-0525	5,250	4,893	410	0,204	0,279	5	0,120	5467
RW-0537	5,375	5,037	420	0,187	0,245	6	0,110	7241
RW-0550	5,500	5,162	430	0,187	0,251	6	0,110	6719
RW-0562	5,625	5,283	440	0,190	0,245	6	0,112	8000
RW-0575	5,750	5,406	450	0,190	0,251	6	0,112	7377
RW-0587	5,875	5,524	460	0,197	0,262	6	0,116	7077
RW-0600	6,000	5,644	470	0,200	0,268	6	0,118	6912

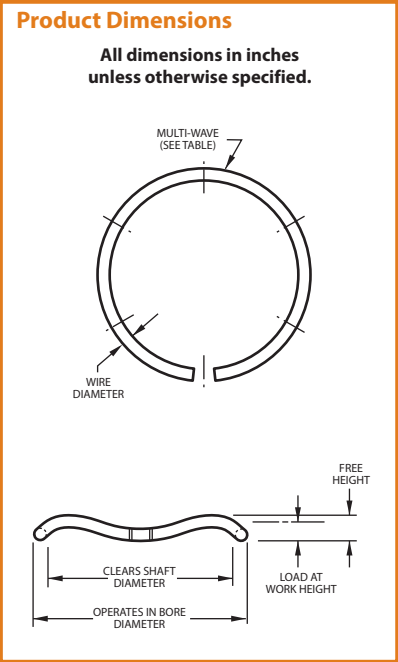
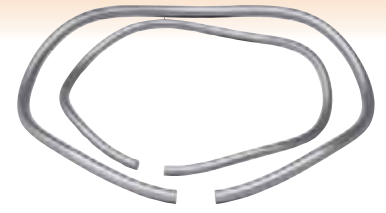

¹ Add suffix "-S17" for 17-7 stainless steel.

² Reference dimension.

³ Theoretical dimension; measured in lb/in.

⁴ See pages 134-135 for How to Order.

⁵ 1 lb = 4,448 N

1 inch = 25,4 mm



Stock Items in carbon steel and 17-7 PH stainless steel.

Smalley Part Number ^{1,2,5}	Operates in Bore Diameter	Clears Shaft Diameter	Load (N)	Work Height	Free Height ³	Number of Waves	Number of Turns	Thickness	Radial Wall	Spring Rate ⁴
CM06-L1*	6	4	6	0,61	1,52	2,5	3	0,13	0,51	6,59
CM06-L2*	6	4	6	0,81	2,03	2,5	4	0,13	0,51	4,92
CM06-L3*	6	4	6	1,02	2,54	2,5	5	0,13	0,51	3,95
CM06-L4*	6	4	6	1,22	3,05	2,5	6	0,13	0,51	3,28
CM06-L5*	6	4	6	1,42	3,56	2,5	7	0,13	0,51	2,80
CM06-L6*	6	4	6	1,63	4,06	2,5	8	0,13	0,51	2,47
CM06-L7*	6	4	6	1,83	4,57	2,5	9	0,13	0,51	2,19
CM06-L8*	6	4	6	2,24	5,59	2,5	11	0,13	0,51	1,79
CM06-L9*	6	4	6	2,64	6,60	2,5	13	0,13	0,51	1,52
CM06-M1*	6	4	12	0,74	1,52	2,5	3	0,15	0,61	15,38
CM06-M2*	6	4	12	0,97	2,03	2,5	4	0,15	0,61	11,32
CM06-M3*	6	4	12	1,22	2,54	2,5	5	0,15	0,61	9,09
CM06-M4*	6	4	12	1,47	3,05	2,5	6	0,15	0,61	7,59
CM06-M5*	6	4	12	1,70	3,56	2,5	7	0,15	0,61	6,45
CM06-M6*	6	4	12	1,96	4,06	2,5	8	0,15	0,61	5,71
CM06-M7*	6	4	12	2,18	4,57	2,5	9	0,15	0,61	5,02
CM06-M8*	6	4	12	2,69	5,59	2,5	11	0,15	0,61	4,14
CM06-M9*	6	4	12	3,18	6,60	2,5	13	0,15	0,61	3,51
CM08-L1	8	5	15	1,70	2,82	2,5	3	0,20	0,81	13,39
CM08-L2	8	5	15	2,39	3,76	2,5	4	0,20	0,81	10,95
CM08-L3	8	5	15	2,74	4,70	2,5	5	0,20	0,81	7,65
CM08-L4	8	5	15	3,56	5,64	2,5	6	0,20	0,81	7,21
CM08-L5	8	5	15	4,01	6,58	2,5	7	0,20	0,81	5,84
CM08-L6	8	5	15	4,57	7,52	2,5	8	0,20	0,81	5,08
CM08-L7	8	5	15	5,26	8,46	2,5	9	0,20	0,81	4,69
CM08-L8	8	5	15	6,35	10,34	2,5	11	0,20	0,81	3,76
CM08-L9	8	5	15	7,37	12,22	2,5	13	0,20	0,81	3,09
CM08-M1	8	5	30	1,78	2,82	2,5	3	0,25	0,81	28,85
CM08-M2	8	5	30	2,54	3,76	2,5	4	0,25	0,81	24,59
CM08-M3	8	5	30	3,05	4,70	2,5	5	0,25	0,81	18,18
CM08-M4	8	5	30	3,81	5,64	2,5	6	0,25	0,81	16,39
CM08-M5	8	5	30	4,32	6,58	2,5	7	0,25	0,81	13,27
CM08-M6	8	5	30	4,95	7,52	2,5	8	0,25	0,81	11,67
CM08-M7	8	5	30	5,59	8,46	2,5	9	0,25	0,81	10,45
CM08-M8	8	5	30	6,86	10,34	2,5	11	0,25	0,81	8,62
CM08-M9	8	5	30	7,87	12,22	2,5	13	0,25	0,81	6,90
CM10-L1	10	7	18	1,91	3,96	2,5	3	0,20	0,81	8,78
CM10-L2	10	7	18	2,54	5,28	2,5	4	0,20	0,81	6,57
CM10-L3	10	7	18	3,15	6,60	2,5	5	0,20	0,81	5,22
CM10-L4	10	7	18	3,78	7,92	2,5	6	0,20	0,81	4,35
CM10-L5	10	7	18	4,42	9,25	2,5	7	0,20	0,81	3,73
CM10-L6	10	7	18	5,05	10,57	2,5	8	0,20	0,81	3,26
CM10-L7	10	7	18	5,69	11,89	2,5	9	0,20	0,81	2,90
CM10-L8	10	7	18	6,32	13,21	2,5	10	0,20	0,81	2,61
CM10-L9	10	7	18	6,96	14,53	2,5	11	0,20	0,81	2,38
CM10-M1	10	7	35	2,03	3,96	2,5	3	0,28	0,81	18,13
CM10-M2	10	7	35	2,79	5,28	2,5	4	0,28	0,81	14,06
CM10-M3	10	7	35	3,56	6,60	2,5	5	0,28	0,81	11,51
CM10-M4	10	7	35	4,32	7,92	2,5	6	0,28	0,81	9,72
CM10-M5	10	7	35	5,08	9,25	2,5	7	0,28	0,81	8,39
CM10-M6	10	7	35	5,84	10,57	2,5	8	0,28	0,81	7,40
CM10-M7	10	7	35	6,60	11,89	2,5	9	0,28	0,81	6,62
CM10-M8	10	7	35	7,37	13,21	2,5	10	0,28	0,81	5,99
CM10-M9	10	7	35	8,13	14,53	2,5	11	0,28	0,81	5,47
CM12-L1	12	9	20	1,47	4,34	2,5	3	0,20	1,02	6,97
CM12-L2	12	9	20	1,98	5,79	2,5	4	0,20	1,02	5,25
CM12-L3	12	9	20	2,46	7,24	2,5	5	0,20	1,02	4,18
CM12-L4	12	9	20	2,95	8,69	2,5	6	0,20	1,02	3,48
CM12-L5	12	9	20	3,45	10,13	2,5	7	0,20	1,02	2,99
CM12-L6	12	9	20	3,94	11,58	2,5	8	0,20	1,02	2,62
CM12-L7	12	9	20	4,45	13,03	2,5	9	0,20	1,02	2,33
CM12-L8	12	9	20	4,93	14,48	2,5	10	0,20	1,02	2,09
CM12-L9	12	9	20	5,44	15,93	2,5	11	0,20	1,02	1,91

Product Dimensions

All dimensions in millimeters unless otherwise specified.

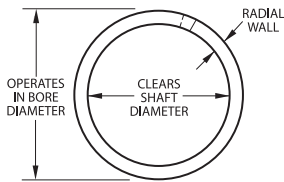

Plain Ends

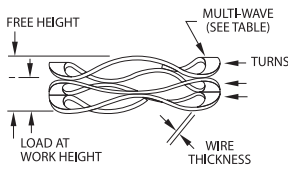

Shim Ends

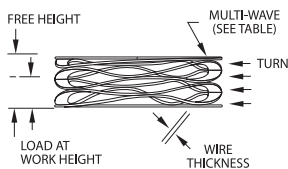

Order Options

CM 030-L1

End options:

Plain ends CM
 Squared-shim ends CMS

Material option:

Carbon Steel (blank)
 Stainless Steel -S17

¹ Use "CM" prefix for plain ends. Use "CMS" prefix for squared-shim ends.

* Not available with shim ends

² Add suffix "-S17" for 17-7 stainless steel.

³ Reference dimension.

⁴ Theoretical dimension; measured in N/mm.

⁵ See pages 134-135 for How to Order.

Stock Items in carbon steel and 17-7 PH stainless steel.

Smalley Part Number ^{1,2,5}	Operates in Bore Diameter	Clears Shaft Diameter	Load (N)	Work Height	Free Height ³	Number of Waves	Number of Turns	Thickness	Radial Wall	Spring Rate ⁴
CM12-M1	12	8,5	40	2,36	4,34	2,5	3	0,28	1,17	20,20
CM12-M2	12	8,5	40	3,18	5,79	2,5	4	0,28	1,17	15,33
CM12-M3	12	8,5	40	3,96	7,24	2,5	5	0,28	1,17	12,20
CM12-M4	12	8,5	40	4,75	8,69	2,5	6	0,28	1,17	10,15
CM12-M5	12	8,5	40	5,54	10,13	2,5	7	0,28	1,17	8,71
CM12-M6	12	8,5	40	6,32	11,58	2,5	8	0,28	1,17	7,60
CM12-M7	12	8,5	40	7,11	13,03	2,5	9	0,28	1,17	6,76
CM12-M8	12	8,5	40	7,92	14,48	2,5	10	0,28	1,17	6,10
CM12-M9	12	8,5	40	8,71	15,93	2,5	11	0,28	1,17	5,54
CM12-H1	12	8,5	60	1,98	4,34	2,5	3	0,30	1,14	25,42
CM12-H2	12	8,5	60	2,64	5,79	2,5	4	0,30	1,14	19,05
CM12-H3	12	8,5	60	3,30	7,24	2,5	5	0,30	1,14	15,23
CM12-H4	12	8,5	60	3,99	8,69	2,5	6	0,30	1,14	12,77
CM12-H5	12	8,5	60	4,65	10,13	2,5	7	0,30	1,14	10,95
CM12-H6	12	8,5	60	5,31	11,58	2,5	8	0,30	1,14	9,57
CM12-H7	12	8,5	60	5,97	13,03	2,5	9	0,30	1,14	8,50
CM12-H8	12	8,5	60	6,63	14,48	2,5	10	0,30	1,14	7,64
CM12-H9	12	8,5	60	7,29	15,93	2,5	11	0,30	1,14	6,94
CM14-L1	14	10	22	2,18	4,95	2,5	3	0,23	1,47	7,94
CM14-L2	14	10	22	2,95	6,60	2,5	4	0,23	1,47	6,03
CM14-L3	14	10	22	3,71	8,26	2,5	5	0,23	1,47	4,84
CM14-L4	14	10	22	4,52	9,91	2,5	6	0,23	1,47	4,08
CM14-L5	14	10	22	5,33	11,56	2,5	7	0,23	1,47	3,53
CM14-L6	14	10	22	6,17	13,21	2,5	8	0,23	1,47	3,13
CM14-L7	14	10	22	7,01	14,86	2,5	9	0,23	1,47	2,80
CM14-L8	14	10	22	7,85	16,51	2,5	10	0,23	1,47	2,54
CM14-L9	14	10	22	8,71	18,16	2,5	11	0,23	1,47	2,33
CM14-M1	14	10	50	2,18	4,95	2,5	3	0,30	1,52	18,05
CM14-M2	14	10	50	2,95	6,60	2,5	4	0,30	1,52	13,70
CM14-M3	14	10	50	3,71	8,26	2,5	5	0,30	1,52	10,99
CM14-M4	14	10	50	4,52	9,91	2,5	6	0,30	1,52	9,28
CM14-M5	14	10	50	5,33	11,56	2,5	7	0,30	1,52	8,03
CM14-M6	14	10	50	6,17	13,21	2,5	8	0,30	1,52	7,10
CM14-M7	14	10	50	7,01	14,86	2,5	9	0,30	1,52	6,37
CM14-M8	14	10	50	7,85	16,51	2,5	10	0,30	1,52	5,77
CM14-M9	14	10	50	8,71	18,16	2,5	11	0,30	1,52	5,29
CM14-H1	14	9	80	3,15	4,95	2,5	3	0,38	1,52	44,44
CM14-H2	14	9	80	4,19	6,60	2,5	4	0,38	1,52	33,20
CM14-H3	14	9	80	5,26	8,26	2,5	5	0,38	1,52	26,67
CM14-H4	14	9	80	6,30	9,91	2,5	6	0,38	1,52	22,16
CM14-H5	14	9	80	7,34	11,56	2,5	7	0,38	1,52	18,96
CM14-H6	14	9	80	8,41	13,21	2,5	8	0,38	1,52	16,67
CM14-H7	14	9	80	9,45	14,86	2,5	9	0,38	1,52	14,79
CM14-H8	14	9	80	10,49	16,51	2,5	10	0,38	1,52	13,29
CM14-H9	14	9	80	11,56	18,16	2,5	11	0,38	1,52	12,12
CM15-L1	15	11	25	2,57	5,18	2,5	3	0,25	1,47	9,58
CM15-L2	15	11	25	3,43	6,91	2,5	4	0,25	1,47	7,18
CM15-L3	15	11	25	4,27	8,64	2,5	5	0,25	1,47	5,72
CM15-L4	15	11	25	5,13	10,36	2,5	6	0,25	1,47	4,78
CM15-L5	15	11	25	5,99	12,09	2,5	7	0,25	1,47	4,10
CM15-L6	15	11	25	6,83	13,82	2,5	8	0,25	1,47	3,58
CM15-L7	15	11	25	7,70	15,54	2,5	9	0,25	1,47	3,19
CM15-L8	15	11	25	8,53	17,27	2,5	10	0,25	1,47	2,86
CM15-L9	15	11	25	9,40	19,00	2,5	11	0,25	1,47	2,60
CM15-M1	15	10	50	3,43	5,18	3,5	3	0,23	1,47	28,57
CM15-M2	15	10	50	4,57	6,91	3,5	4	0,23	1,47	21,37
CM15-M3	15	10	50	5,72	8,64	3,5	5	0,23	1,47	17,12
CM15-M4	15	10	50	6,86	10,36	3,5	6	0,23	1,47	14,29
CM15-M5	15	10	50	8,00	12,09	3,5	7	0,23	1,47	12,22
CM15-M6	15	10	50	9,14	13,82	3,5	8	0,23	1,47	10,68
CM15-M7	15	10	50	10,29	15,54	3,5	9	0,23	1,47	9,52
CM15-M8	15	10	50	11,43	17,27	3,5	10	0,23	1,47	8,56
CM15-M9	15	10	50	12,57	19,00	3,5	11	0,23	1,47	7,78

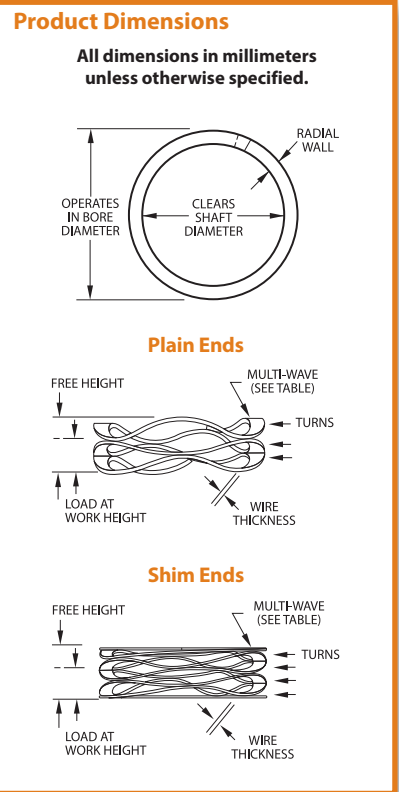

Order Options

CM 030-L1

End options:
 Plain ends **CM**
 Squared-shim ends **CMS**

Material option:
 Carbon Steel **(blank)**
 Stainless Steel **-S17**

¹ Use "CM" prefix for plain ends. Use "CMS" prefix for squared-shim ends.

² Add suffix "-S17" for 17-7 stainless steel.

³ Reference dimension.

⁴ Theoretical dimension; measured in N/mm.

⁵ See pages 134-135 for How to Order.



Stock Items in carbon steel and 17-7 PH stainless steel.

Smalley Part Number ^{1,2,5}	Operates in Bore Diameter	Clears Shaft Diameter	Load (N)	Work Height	Free Height ³	Number of Waves	Number of Turns	Thickness	Radial Wall	Spring Rate ⁴
CM15-H1	15	10	80	3,20	5,18	3,5	3	0,25	1,47	40,40
CM15-H2	15	10	80	4,19	6,91	3,5	4	0,25	1,47	29,41
CM15-H3	15	10	80	5,23	8,64	3,5	5	0,25	1,47	23,46
CM15-H4	15	10	80	6,27	10,36	3,5	6	0,25	1,47	19,56
CM15-H5	15	10	80	7,32	12,09	3,5	7	0,25	1,47	16,77
CM15-H6	15	10	80	8,36	13,82	3,5	8	0,25	1,47	14,65
CM15-H7	15	10	80	9,40	15,54	3,5	9	0,25	1,47	13,03
CM15-H8	15	10	80	10,46	17,27	3,5	10	0,25	1,47	11,75
CM15-H9	15	10	80	11,51	19,00	3,5	11	0,25	1,47	10,68
CM16-L1	16	11	25	2,11	5,41	2,5	3	0,25	1,47	7,58
CM16-L2	16	11	25	2,79	7,21	2,5	4	0,25	1,47	5,66
CM16-L3	16	11	25	3,51	9,02	2,5	5	0,25	1,47	4,54
CM16-L4	16	11	25	4,19	10,82	2,5	6	0,25	1,47	3,77
CM16-L5	16	11	25	4,90	12,62	2,5	7	0,25	1,47	3,24
CM16-L6	16	11	25	6,30	16,23	2,5	9	0,25	1,47	2,52
CM16-L7	16	11	25	7,70	19,84	2,5	11	0,25	1,47	2,06
CM16-L8	16	11	25	9,09	23,44	2,5	13	0,25	1,47	1,74
CM16-M1	16	11	55	3,63	5,41	3,5	3	0,25	1,47	30,90
CM16-M2	16	11	55	4,83	7,21	3,5	4	0,25	1,47	23,11
CM16-M3	16	11	55	6,05	9,02	3,5	5	0,25	1,47	18,52
CM16-M4	16	11	55	7,24	10,82	3,5	6	0,25	1,47	15,36
CM16-M5	16	11	55	8,46	12,62	3,5	7	0,25	1,47	13,22
CM16-M6	16	11	55	10,87	16,23	3,5	9	0,25	1,47	10,26
CM16-M7	16	11	55	13,28	19,84	3,5	11	0,25	1,47	8,38
CM16-M8	16	11	55	15,70	23,44	3,5	13	0,25	1,47	7,11
CM16-H1	16	11	90	3,30	5,41	3,5	3	0,30	1,52	65,61
CM16-H2	16	11	90	4,57	7,21	3,5	4	0,30	1,52	48,09
CM16-H3	16	11	90	5,59	9,02	3,5	5	0,30	1,52	38,24
CM16-H4	16	11	90	6,86	10,82	3,5	6	0,30	1,52	31,73
CM16-H5	16	11	90	7,87	12,62	3,5	7	0,30	1,52	27,95
CM16-H6	16	11	90	10,16	16,23	3,5	9	0,30	1,52	21,83
CM16-H7	16	11	90	12,45	19,84	3,5	11	0,30	1,52	18,18
CM16-H8	16	11	90	14,73	23,44	3,5	13	0,30	1,52	15,33
CM18-L1	18	13	30	3,63	5,72	3,5	3	0,20	1,80	14,35
CM18-L2	18	13	30	4,75	7,62	3,5	4	0,20	1,80	10,45
CM18-L3	18	13	30	5,94	9,53	3,5	5	0,20	1,80	8,36
CM18-L4	18	13	30	7,14	11,43	3,5	6	0,20	1,80	6,99
CM18-L5	18	13	30	8,31	13,34	3,5	7	0,20	1,80	5,96
CM18-L6	18	13	30	10,69	17,15	3,5	9	0,20	1,80	4,64
CM18-L7	18	13	30	14,25	22,86	3,5	12	0,20	1,80	3,48
CM18-M1	18	13	55	3,68	5,72	3,5	3	0,25	1,83	26,96
CM18-M2	18	13	55	4,98	7,62	3,5	4	0,25	1,83	20,83
CM18-M3	18	13	55	6,22	9,53	3,5	5	0,25	1,83	16,62
CM18-M4	18	13	55	7,47	11,43	3,5	6	0,25	1,83	13,89
CM18-M5	18	13	55	8,74	13,34	3,5	7	0,25	1,83	11,96
CM18-M6	18	13	55	11,23	17,15	3,5	9	0,25	1,83	9,29
CM18-M7	18	13	55	14,96	22,86	3,5	12	0,25	1,83	6,96
CM18-H1	18	13	90	3,84	5,72	3,5	3	0,30	1,83	47,87
CM18-H2	18	13	90	5,13	7,62	3,5	4	0,30	1,83	36,14
CM18-H3	18	13	90	6,40	9,53	3,5	5	0,30	1,83	28,75
CM18-H4	18	13	90	7,70	11,43	3,5	6	0,30	1,83	24,13
CM18-H5	18	13	90	8,97	13,34	3,5	7	0,30	1,83	20,59
CM18-H6	18	13	90	11,53	17,15	3,5	9	0,30	1,83	16,01
CM18-H7	18	13	90	15,37	22,86	3,5	12	0,30	1,83	12,02
CM20-L1	20	15	35	2,72	6,32	3,5	3	0,20	1,80	9,72
CM20-L2	20	15	35	3,61	8,43	3,5	4	0,20	1,80	7,26
CM20-L3	20	15	35	4,52	10,54	3,5	5	0,20	1,80	5,81
CM20-L4	20	15	35	5,41	12,65	3,5	6	0,20	1,80	4,83
CM20-L5	20	15	35	6,32	14,76	3,5	7	0,20	1,80	4,15
CM20-L6	20	15	35	8,13	18,97	3,5	9	0,20	1,80	3,23
CM20-L7	20	15	35	10,82	25,30	3,5	12	0,20	1,80	2,42
CM20-M1	20	14	70	3,05	6,32	3,5	3	0,25	1,98	21,41
CM20-M2	20	14	70	4,06	8,43	3,5	4	0,25	1,98	16,02
CM20-M3	20	14	70	5,08	10,54	3,5	5	0,25	1,98	12,82

Product Dimensions

All dimensions in millimeters unless otherwise specified.

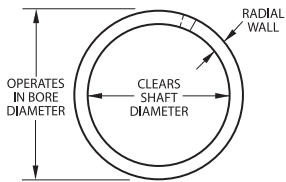

Plain Ends

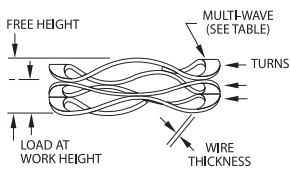

Shim Ends

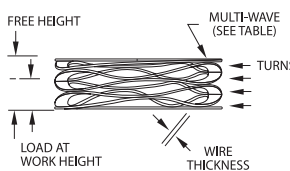

Order Options

CM 030-L1

End options:

Plain ends CM
 Squared-shim ends CMS

Material option:

Carbon Steel (blank)
 Stainless Steel -S17

¹ Use "CM" prefix for plain ends. Use "CMS" prefix for squared-shim ends.

² Add suffix "-S17" for 17-7 stainless steel.

³ Reference dimension.

⁴ Theoretical dimension; measured in N/mm.

⁵ See pages 134-135 for How to Order.

Stock Items in carbon steel and 17-7 PH stainless steel.

Smalley Part Number ^{1,2,5}	Operates in Bore Diameter	Clears Shaft Diameter	Load (N)	Work Height	Free Height ³	Number of Waves	Number of Turns	Thickness	Radial Wall	Spring Rate ⁴
CM20-M4	20	14	70	6,27	12,65	3,5	6	0,25	1,98	10,97
CM20-M5	20	14	70	7,32	14,76	3,5	7	0,25	1,98	9,41
CM20-M6	20	14	70	9,17	18,97	3,5	9	0,25	1,98	7,14
CM20-M7	20	14	70	12,22	25,30	3,5	12	0,25	1,98	5,35
CM20-H1	20	14	100	4,24	6,32	3,5	3	0,33	2,01	48,08
CM20-H2	20	14	100	5,66	8,43	3,5	4	0,33	2,01	36,10
CM20-H3	20	14	100	7,06	10,54	3,5	5	0,33	2,01	28,74
CM20-H4	20	14	100	8,48	12,65	3,5	6	0,33	2,01	23,98
CM20-H5	20	14	100	9,91	14,76	3,5	7	0,33	2,01	20,62
CM20-H6	20	14	100	12,73	18,97	3,5	9	0,33	2,01	16,03
CM20-H7	20	14	100	16,97	25,30	3,5	12	0,33	2,01	12,00
CM25-L1	25	19	50	2,06	6,63	3,5	3	0,25	2,18	10,94
CM25-L2	25	19	50	2,74	8,84	3,5	4	0,25	2,18	8,20
CM25-L3	25	19	50	3,43	11,05	3,5	5	0,25	2,18	6,56
CM25-L4	25	19	50	4,11	13,26	3,5	6	0,25	2,18	5,46
CM25-L5	25	19	50	4,80	15,47	3,5	7	0,25	2,18	4,69
CM25-L6	25	19	50	6,20	19,89	3,5	9	0,25	2,18	3,65
CM25-L7	25	19	50	8,26	26,52	3,5	12	0,25	2,18	2,74
CM25-M1	25	19	80	2,95	6,63	3,5	3	0,30	2,39	21,74
CM25-M2	25	19	80	3,94	8,84	3,5	4	0,30	2,39	16,33
CM25-M3	25	19	80	4,90	11,05	3,5	5	0,30	2,39	13,01
CM25-M4	25	19	80	5,89	13,26	3,5	6	0,30	2,39	10,85
CM25-M5	25	19	80	6,88	15,47	3,5	7	0,30	2,39	9,31
CM25-M6	25	19	80	8,84	19,89	3,5	9	0,30	2,39	7,24
CM25-M7	25	19	80	11,79	26,52	3,5	12	0,30	2,39	5,43
CM25-H1	25	19	110	4,04	6,63	3,5	3	0,38	2,39	42,47
CM25-H2	25	19	110	5,38	8,84	3,5	4	0,38	2,39	31,79
CM25-H3	25	19	110	6,73	11,05	3,5	5	0,38	2,39	25,46
CM25-H4	25	19	110	8,08	13,26	3,5	6	0,38	2,39	21,24
CM25-H5	25	19	110	9,40	15,47	3,5	7	0,38	2,39	18,12
CM25-H6	25	19	110	12,12	19,89	3,5	9	0,38	2,39	14,16
CM25-H7	25	19	110	16,15	26,52	3,5	12	0,38	2,39	10,61
CM28-L1	28	22	50	3,76	7,24	3,5	3	0,30	2,39	14,37
CM28-L2	28	22	50	5,00	9,65	3,5	4	0,30	2,39	10,75
CM28-L3	28	22	50	6,27	12,07	3,5	5	0,30	2,39	8,62
CM28-L4	28	22	50	7,52	14,48	3,5	6	0,30	2,39	7,18
CM28-L5	28	22	50	8,79	16,89	3,5	7	0,30	2,39	6,17
CM28-L6	28	22	50	10,03	19,30	3,5	8	0,30	2,39	5,39
CM28-L7	28	22	50	11,28	21,72	3,5	9	0,30	2,39	4,79
CM28-L8	28	22	50	13,79	26,54	3,5	11	0,30	2,39	3,92
CM28-L9	28	22	50	16,31	31,37	3,5	13	0,30	2,39	3,32
CM28-M1	28	22	80	4,39	7,24	3,5	3	0,38	2,39	28,07
CM28-M2	28	22	80	5,84	9,65	3,5	4	0,38	2,39	21,00
CM28-M3	28	22	80	7,32	12,07	3,5	5	0,38	2,39	16,84
CM28-M4	28	22	80	8,79	14,48	3,5	6	0,38	2,39	14,06
CM28-M5	28	22	80	10,24	16,89	3,5	7	0,38	2,39	12,03
CM28-M6	28	22	80	11,71	19,30	3,5	8	0,38	2,39	10,54
CM28-M7	28	22	80	13,18	21,72	3,5	9	0,38	2,39	9,37
CM28-M8	28	22	80	16,10	26,54	3,5	11	0,38	2,39	7,66
CM28-M9	28	22	80	19,02	31,37	3,5	13	0,38	2,39	6,48
CM28-H1	28	22	130	4,57	7,24	3,5	3	0,46	2,39	48,69
CM28-H2	28	22	130	6,07	9,65	3,5	4	0,46	2,39	36,31
CM28-H3	28	22	130	7,59	12,07	3,5	5	0,46	2,39	29,02
CM28-H4	28	22	130	9,12	14,48	3,5	6	0,46	2,39	24,25
CM28-H5	28	22	130	10,64	16,89	3,5	7	0,46	2,39	20,80
CM28-H6	28	22	130	12,17	19,30	3,5	8	0,46	2,39	18,23
CM28-H7	28	22	130	13,69	21,72	3,5	9	0,46	2,39	16,19
CM28-H8	28	22	130	16,71	26,54	3,5	11	0,46	2,39	13,22
CM28-H9	28	22	130	19,76	31,37	3,5	13	0,46	2,39	11,20
CM30-L1	30	24	50	3,18	7,62	3,5	3	0,30	2,39	11,26
CM30-L2	30	24	50	4,22	10,16	3,5	4	0,30	2,39	8,42
CM30-L3	30	24	50	5,28	12,70	3,5	5	0,30	2,39	6,74
CM30-L4	30	24	50	6,32	15,24	3,5	6	0,30	2,39	5,61
CM30-L5	30	24	50	7,39	17,78	3,5	7	0,30	2,39	4,81



Product Dimensions

All dimensions in millimeters unless otherwise specified.

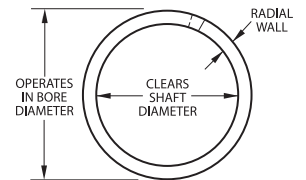

Plain Ends

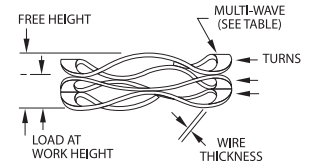

Shim Ends

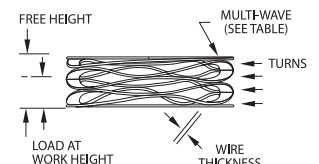

Order Options

CM 030-L1

End options:

Plain ends CM
 Squared-shim ends CMS

Material option:

Carbon Steel (blank)
 Stainless Steel -S17

¹ Use "CM" prefix for plain ends. Use "CMS" prefix for squared-shim ends.

² Add suffix "-S17" for 17-7 stainless steel.

³ Reference dimension.

⁴ Theoretical dimension; measured in N/mm.

⁵ See pages 134-135 for How to Order.



Stock Items in carbon steel and 17-7 PH stainless steel.

Smalley Part Number ^{1,2,5}	Operates in Bore Diameter	Clears Shaft Diameter	Load (N)	Work Height	Free Height ³	Number of Waves	Number of Turns	Thickness	Radial Wall	Spring Rate ⁴
CM30-L6	30	24	50	8,43	20,32	3,5	8	0,30	2,39	4,21
CM30-L7	30	24	50	9,50	22,86	3,5	9	0,30	2,39	3,74
CM30-L8	30	24	50	11,61	27,94	3,5	11	0,30	2,39	3,06
CM30-L9	30	24	50	13,72	33,02	3,5	13	0,30	2,39	2,59
CM30-M1	30	24	90	3,51	7,62	3,5	3	0,38	2,39	21,90
CM30-M2	30	24	90	4,70	10,16	3,5	4	0,38	2,39	16,48
CM30-M3	30	24	90	5,87	12,70	3,5	5	0,38	2,39	13,18
CM30-M4	30	24	90	7,04	15,24	3,5	6	0,38	2,39	10,98
CM30-M5	30	24	90	8,20	17,78	3,5	7	0,38	2,39	9,39
CM30-M6	30	24	90	9,37	20,32	3,5	8	0,38	2,39	8,22
CM30-M7	30	24	90	10,54	22,86	3,5	9	0,38	2,39	7,31
CM30-M8	30	24	90	12,90	27,94	3,5	11	0,38	2,39	5,98
CM30-M9	30	24	90	15,24	33,02	3,5	13	0,38	2,39	5,06
CM30-H1	30	24	130	4,19	7,62	3,5	3	0,46	2,39	37,90
CM30-H2	30	24	130	5,59	10,16	3,5	4	0,46	2,39	28,45
CM30-H3	30	24	130	6,99	12,70	3,5	5	0,46	2,39	22,77
CM30-H4	30	24	130	8,38	15,24	3,5	6	0,46	2,39	18,95
CM30-H5	30	24	130	9,78	17,78	3,5	7	0,46	2,39	16,25
CM30-H6	30	24	130	11,18	20,32	3,5	8	0,46	2,39	14,22
CM30-H7	30	24	130	12,57	22,86	3,5	9	0,46	2,39	12,63
CM30-H8	30	24	130	15,37	27,94	3,5	11	0,46	2,39	10,34
CM30-H9	30	24	130	18,16	33,02	3,5	13	0,46	2,39	8,75
CM35-L1	35	27	70	3,94	8,38	3,5	3	0,36	3,18	15,77
CM35-L2	35	27	70	5,23	11,18	3,5	4	0,36	3,18	11,76
CM35-L3	35	27	70	6,55	13,97	3,5	5	0,36	3,18	9,43
CM35-L4	35	27	70	7,87	16,76	3,5	6	0,36	3,18	7,87
CM35-L5	35	27	70	9,17	19,56	3,5	7	0,36	3,18	6,74
CM35-L6	35	27	70	10,49	22,35	3,5	8	0,36	3,18	5,90
CM35-L7	35	27	70	11,81	25,15	3,5	9	0,36	3,18	5,25
CM35-L8	35	27	70	14,43	30,73	3,5	11	0,36	3,18	4,29
CM35-L9	35	27	70	17,04	36,32	3,5	13	0,36	3,18	3,63
CM35-M1	35	27	110	4,14	8,38	3,5	3	0,41	3,38	25,94
CM35-M2	35	27	110	5,51	11,18	3,5	4	0,41	3,38	19,40
CM35-M3	35	27	110	6,88	13,97	3,5	5	0,41	3,38	15,51
CM35-M4	35	27	110	8,26	16,76	3,5	6	0,41	3,38	12,94
CM35-M5	35	27	110	9,63	19,56	3,5	7	0,41	3,38	11,08
CM35-M6	35	27	110	11,02	22,35	3,5	8	0,41	3,38	9,71
CM35-M7	35	27	110	12,40	25,15	3,5	9	0,41	3,38	8,63
CM35-M8	35	27	110	15,14	30,73	3,5	11	0,41	3,38	7,06
CM35-M9	35	27	110	17,91	36,32	3,5	13	0,41	3,38	5,98
CM35-H1	35	27	160	4,04	8,38	3,5	3	0,46	3,38	36,87
CM35-H2	35	27	160	5,38	11,18	3,5	4	0,46	3,38	27,59
CM35-H3	35	27	160	6,73	13,97	3,5	5	0,46	3,38	22,10
CM35-H4	35	27	160	8,08	16,76	3,5	6	0,46	3,38	18,43
CM35-H5	35	27	160	9,42	19,56	3,5	7	0,46	3,38	15,78
CM35-H6	35	27	160	10,77	22,35	3,5	8	0,46	3,38	13,82
CM35-H7	35	27	160	12,12	25,15	3,5	9	0,46	3,38	12,28
CM35-H8	35	27	160	14,81	30,73	3,5	11	0,46	3,38	10,05
CM35-H9	35	27	160	17,50	36,32	3,5	13	0,46	3,38	8,50
CM40-L1	40	30	100	2,90	9,14	3,5	3	0,41	3,38	16,03
CM40-L2	40	30	100	3,86	12,19	3,5	4	0,41	3,38	12,00
CM40-L3	40	30	100	4,80	15,24	3,5	5	0,41	3,38	9,58
CM40-L4	40	30	100	5,77	18,29	3,5	6	0,41	3,38	7,99
CM40-L5	40	30	100	6,73	21,34	3,5	7	0,41	3,38	6,84
CM40-L6	40	30	100	7,70	24,38	3,5	8	0,41	3,38	6,00
CM40-L7	40	30	100	8,66	27,43	3,5	9	0,41	3,38	5,33
CM40-L8	40	30	100	10,59	33,53	3,5	11	0,41	3,38	4,36
CM40-L9	40	30	100	12,52	39,62	3,5	13	0,41	3,38	3,69
CM40-M1	40	30	150	5,44	9,14	3,5	3	0,53	3,63	40,54
CM40-M2	40	30	150	7,24	12,19	3,5	4	0,53	3,63	30,30
CM40-M3	40	30	150	9,04	15,24	3,5	5	0,53	3,63	24,19
CM40-M4	40	30	150	10,85	18,29	3,5	6	0,53	3,63	20,16
CM40-M5	40	30	150	12,65	21,34	3,5	7	0,53	3,63	17,26

Product Dimensions

All dimensions in millimeters unless otherwise specified.

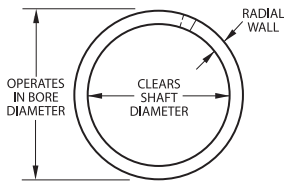

Plain Ends

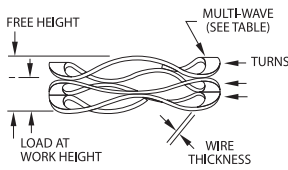

Shim Ends

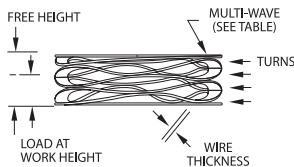

Order Options

CM 030-L1

End options:

Plain ends CM
 Squared-shim ends CMS

Material option:

Carbon Steel (blank)
 Stainless Steel -S17

¹ Use "CM" prefix for plain ends. Use "CMS" prefix for squared-shim ends.

² Add suffix "-S17" for 17-7 stainless steel.

³ Reference dimension.

⁴ Theoretical dimension; measured in N/mm.

⁵ See pages 134-135 for How to Order.

Stock Items in carbon steel and 17-7 PH stainless steel.

Smalley Part Number ^{1,2,5}	Operates in Bore Diameter	Clears Shaft Diameter	Load (N)	Work Height	Free Height ³	Number of Waves	Number of Turns	Thickness	Radial Wall	Spring Rate ⁴
CM40-M6	40	30	150	14,48	24,38	3,5	8	0,53	3,63	15,15
CM40-M7	40	30	150	16,28	27,43	3,5	9	0,53	3,63	13,45
CM40-M8	40	30	150	19,89	33,53	3,5	11	0,53	3,63	11,00
CM40-M9	40	30	150	23,50	39,62	3,5	13	0,53	3,63	9,31
CM40-H1	40	30	300	5,66	9,14	4,5	3	0,46	3,38	86,21
CM40-H2	40	30	300	7,54	12,19	4,5	4	0,46	3,38	64,52
CM40-H3	40	30	300	9,42	15,24	4,5	5	0,46	3,38	51,55
CM40-H4	40	30	300	11,33	18,29	4,5	6	0,46	3,38	43,10
CM40-H5	40	30	300	13,21	21,34	4,5	7	0,46	3,38	36,90
CM40-H6	40	30	300	15,09	24,38	4,5	8	0,46	3,38	32,29
CM40-H7	40	30	300	16,97	27,43	4,5	9	0,46	3,38	28,68
CM40-H8	40	30	300	20,75	33,53	4,5	11	0,46	3,38	23,47
CM40-H9	40	30	300	24,54	39,62	4,5	13	0,46	3,38	19,89
CM45-L1	45	35	110	3,38	9,91	3,5	3	0,46	3,63	16,85
CM45-L2	45	35	110	4,52	13,21	3,5	4	0,46	3,63	12,66
CM45-L3	45	35	110	5,64	16,51	3,5	5	0,46	3,63	10,12
CM45-L4	45	35	110	6,76	19,81	3,5	6	0,46	3,63	8,43
CM45-L5	45	35	110	7,90	23,11	3,5	7	0,46	3,63	7,23
CM45-L6	45	35	110	9,02	26,42	3,5	8	0,46	3,63	6,32
CM45-L7	45	35	110	10,16	29,72	3,5	9	0,46	3,63	5,62
CM45-L8	45	35	110	12,40	36,32	3,5	11	0,46	3,63	4,60
CM45-L9	45	35	110	14,66	42,93	3,5	13	0,46	3,63	3,89
CM45-M1	45	35	225	5,33	9,91	4,5	3	0,46	3,63	49,13
CM45-M2	45	35	225	6,99	13,21	4,5	4	0,46	3,63	36,17
CM45-M3	45	35	225	9,14	16,51	4,5	5	0,46	3,63	30,53
CM45-M4	45	35	225	10,80	19,81	4,5	6	0,46	3,63	24,97
CM45-M5	45	35	225	12,70	23,11	4,5	7	0,46	3,63	21,61
CM45-M6	45	35	225	14,48	26,42	4,5	8	0,46	3,63	18,84
CM45-M7	45	35	225	16,26	29,72	4,5	9	0,46	3,63	16,72
CM45-M8	45	35	225	19,81	36,32	4,5	11	0,46	3,63	13,63
CM45-M9	45	35	225	23,37	42,93	4,5	13	0,46	3,63	11,50
CM45-H1	45	35	400	6,43	9,91	4,5	3	0,61	3,76	114,94
CM45-H2	45	35	400	8,38	13,21	4,5	4	0,61	3,76	82,82
CM45-H3	45	35	400	11,20	16,51	4,5	5	0,61	3,76	75,33
CM45-H4	45	35	400	12,95	19,81	4,5	6	0,61	3,76	58,31
CM45-H5	45	35	400	15,37	23,11	4,5	7	0,61	3,76	51,68
CM45-H6	45	35	400	17,27	26,42	4,5	8	0,61	3,76	43,72
CM45-H7	45	35	400	19,68	29,72	4,5	9	0,61	3,76	39,88
CM45-H8	45	35	400	24,26	36,32	4,5	11	0,61	3,76	33,17
CM45-H9	45	35	400	28,45	42,93	4,5	13	0,61	3,76	27,62
CM50-L1	50	40	110	4,83	10,29	3,5	3	0,53	3,63	20,15
CM50-L2	50	40	110	6,10	13,72	3,5	4	0,53	3,63	14,44
CM50-L3	50	40	110	7,87	17,15	3,5	5	0,53	3,63	11,85
CM50-L4	50	40	110	9,40	20,57	3,5	6	0,53	3,63	9,85
CM50-L5	50	40	110	11,30	24,00	3,5	7	0,53	3,63	8,66
CM50-L6	50	40	110	12,70	27,43	3,5	8	0,53	3,63	7,47
CM50-L7	50	40	110	14,99	30,86	3,5	9	0,53	3,63	6,93
CM50-L8	50	40	110	18,16	37,72	3,5	11	0,53	3,63	5,62
CM50-L9	50	40	110	21,34	44,58	3,5	13	0,53	3,63	4,73
CM50-L10	50	40	110	24,64	51,44	3,5	15	0,53	3,63	4,10
CM50-M1	50	40	225	4,62	10,29	4,5	3	0,46	3,63	39,68
CM50-M2	50	40	225	6,35	13,72	4,5	4	0,46	3,63	30,53
CM50-M3	50	40	225	7,49	17,15	4,5	5	0,46	3,63	23,29
CM50-M4	50	40	225	8,89	20,57	4,5	6	0,46	3,63	19,26
CM50-M5	50	40	225	10,54	24,00	4,5	7	0,46	3,63	16,72
CM50-M6	50	40	225	11,89	27,43	4,5	8	0,46	3,63	14,48
CM50-M7	50	40	225	13,59	30,86	4,5	9	0,46	3,63	13,03
CM50-M8	50	40	225	16,71	37,72	4,5	11	0,46	3,63	10,71
CM50-M9	50	40	225	19,61	44,58	4,5	13	0,46	3,63	9,01
CM50-M10	50	40	225	22,48	51,44	4,5	15	0,46	3,63	7,77
CM50-H1	50	40	400	5,92	10,29	4,5	3	0,61	3,76	91,53
CM50-H2	50	40	400	7,80	13,72	4,5	4	0,61	3,76	67,57
CM50-H3	50	40	400	10,16	17,15	4,5	5	0,61	3,76	57,22
CM50-H4	50	40	400	11,79	20,57	4,5	6	0,61	3,76	45,56
CM50-H5	50	40	400	14,15	24,00	4,5	7	0,61	3,76	40,61
CM50-H6	50	40	400	15,62	27,43	4,5	8	0,61	3,76	33,87

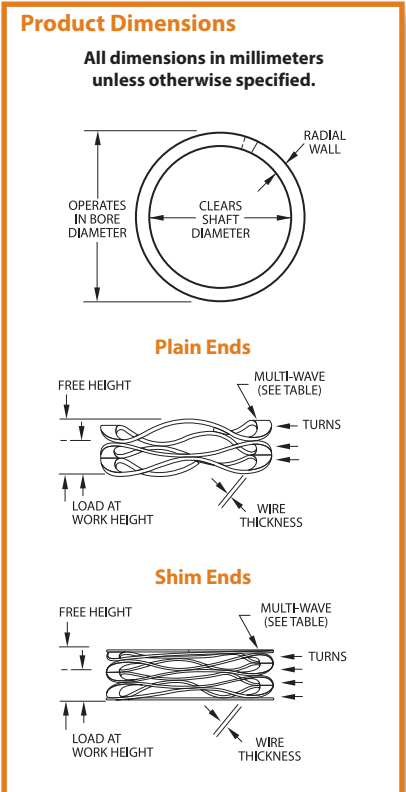

Order Options

CM 030-L1

End options:
 Plain ends **CM**
 Squared-shim ends **CMS**

Material option:
 Carbon Steel **(blank)**
 Stainless Steel **-S17**

¹ Use "CM" prefix for plain ends. Use "CMS" prefix for squared-shim ends.
² Add suffix "-S17" for 17-7 stainless steel.

³ Reference dimension.
⁴ Theoretical dimension; measured in N/mm.
⁵ See pages 134-135 for How to Order.



Stock Items in carbon steel and 17-7 PH stainless steel.

Smalley Part Number ^{1,2,5}	Operates in Bore Diameter	Clears Shaft Diameter	Load (N)	Work Height	Free Height ³	Number of Waves	Number of Turns	Thickness	Radial Wall	Spring Rate ⁴
CM50-H7	50	40	400	17,91	30,86	4,5	9	0,61	3,76	30,89
CM50-H8	50	40	400	21,54	37,72	4,5	11	0,61	3,76	24,72
CM50-H9	50	40	400	25,65	44,58	4,5	13	0,61	3,76	21,13
CM50-H10	50	40	400	29,21	51,44	4,5	15	0,61	3,76	17,99
CM55-L1	55	45	125	5,59	11,05	3,5	3	0,61	3,76	22,89
CM55-L2	55	45	125	7,72	14,73	3,5	4	0,61	3,76	17,83
CM55-L3	55	45	125	9,68	18,41	3,5	5	0,61	3,76	14,30
CM55-L4	55	45	125	11,48	22,10	3,5	6	0,61	3,76	11,77
CM55-L5	55	45	125	13,92	25,78	3,5	7	0,61	3,76	10,54
CM55-L6	55	45	125	15,52	29,46	3,5	8	0,61	3,76	8,97
CM55-L7	55	45	125	18,41	33,15	3,5	9	0,61	3,76	8,49
CM55-L8	55	45	125	21,67	40,51	3,5	11	0,61	3,76	6,63
CM55-L9	55	45	125	25,65	47,88	3,5	13	0,61	3,76	5,62
CM55-L10	55	45	125	29,77	55,25	3,5	15	0,61	3,76	4,91
CM55-M1	55	45	250	3,10	11,05	4,5	3	0,46	3,63	31,45
CM55-M2	55	45	250	4,11	14,73	4,5	4	0,46	3,63	23,54
CM55-M3	55	45	250	5,16	18,41	4,5	5	0,46	3,63	18,85
CM55-M4	55	45	250	6,20	22,10	4,5	6	0,46	3,63	15,72
CM55-M5	55	45	250	7,21	25,78	4,5	7	0,46	3,63	13,46
CM55-M6	55	45	250	8,26	29,46	4,5	8	0,46	3,63	11,79
CM55-M7	55	45	250	9,27	33,15	4,5	9	0,46	3,63	10,47
CM55-M8	55	45	250	11,33	40,51	4,5	11	0,46	3,63	8,57
CM55-M9	55	45	250	13,41	47,88	4,5	13	0,46	3,63	7,25
CM55-M10	55	45	250	15,47	55,25	4,5	15	0,46	3,63	6,28
CM55-H1	55	45	400	5,31	11,05	4,5	3	0,61	3,76	69,69
CM55-H2	55	45	400	7,24	14,73	4,5	4	0,61	3,76	53,40
CM55-H3	55	45	400	9,09	18,41	4,5	5	0,61	3,76	42,87
CM55-H4	55	45	400	10,64	22,10	4,5	6	0,61	3,76	34,90
CM55-H5	55	45	400	12,24	25,78	4,5	7	0,61	3,76	29,54
CM55-H6	55	45	400	14,10	29,46	4,5	8	0,61	3,76	26,04
CM55-H7	55	45	400	15,82	33,15	4,5	9	0,61	3,76	23,08
CM55-H8	55	45	400	19,30	40,51	4,5	11	0,61	3,76	18,86
CM55-H9	55	45	400	23,11	47,88	4,5	13	0,61	3,76	16,15
CM55-H10	55	45	400	26,54	55,25	4,5	15	0,61	3,76	13,93
CM60-L1	60	50	135	5,59	11,43	4,5	3	0,46	3,63	23,12
CM60-L2	60	50	135	7,47	15,24	4,5	4	0,46	3,63	17,37
CM60-L3	60	50	135	9,32	19,05	4,5	5	0,46	3,63	13,87
CM60-L4	60	50	135	11,20	22,86	4,5	6	0,46	3,63	11,58
CM60-L5	60	50	135	13,06	26,67	4,5	7	0,46	3,63	9,92
CM60-L6	60	50	135	14,94	30,48	4,5	8	0,46	3,63	8,69
CM60-L7	60	50	135	16,79	34,29	4,5	9	0,46	3,63	7,71
CM60-L8	60	50	135	20,52	41,91	4,5	11	0,46	3,63	6,31
CM60-L9	60	50	135	24,26	49,53	4,5	13	0,46	3,63	5,34
CM60-L10	60	50	135	27,99	57,15	4,5	15	0,46	3,63	4,63
CM60-M1	60	50	275	6,65	11,43	4,5	3	0,61	3,76	57,53
CM60-M2	60	50	275	8,86	15,24	4,5	4	0,61	3,76	43,10
CM60-M3	60	50	275	11,07	19,05	4,5	5	0,61	3,76	34,46
CM60-M4	60	50	275	13,28	22,86	4,5	6	0,61	3,76	28,71
CM60-M5	60	50	275	15,49	26,67	4,5	7	0,61	3,76	24,60
CM60-M6	60	50	275	17,70	30,48	4,5	8	0,61	3,76	21,52
CM60-M7	60	50	275	19,94	34,29	4,5	9	0,61	3,76	19,16
CM60-M8	60	50	275	24,36	41,91	4,5	11	0,61	3,76	15,67
CM60-M9	60	50	275	28,78	49,53	4,5	13	0,61	3,76	13,25
CM60-M10	60	50	275	33,22	57,15	4,5	15	0,61	3,76	11,49
CM60-H1	60	50	450	7,75	11,43	4,5	3	0,76	4,01	122,28
CM60-H2	60	50	450	10,31	15,24	4,5	4	0,76	4,01	91,28
CM60-H3	60	50	450	12,90	19,05	4,5	5	0,76	4,01	73,17
CM60-H4	60	50	450	15,47	22,86	4,5	6	0,76	4,01	60,89
CM60-H5	60	50	450	18,06	26,67	4,5	7	0,76	4,01	52,26
CM60-H6	60	50	450	20,62	30,48	4,5	8	0,76	4,01	45,64
CM60-H7	60	50	450	23,22	34,29	4,5	9	0,76	4,01	40,65
CM60-H8	60	50	450	28,37	41,91	4,5	11	0,76	4,01	33,23
CM60-H9	60	50	450	33,53	49,53	4,5	13	0,76	4,01	28,13
CM60-H10	60	50	450	38,68	57,15	4,5	15	0,76	4,01	24,36

Product Dimensions

All dimensions in millimeters unless otherwise specified.

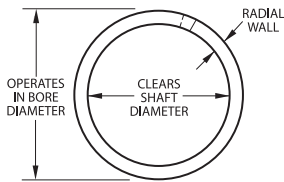

Plain Ends

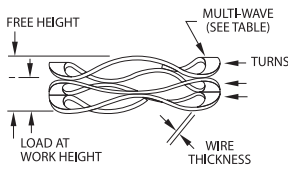

Shim Ends

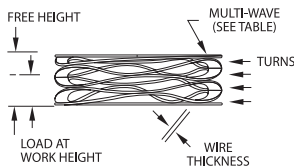

Order Options

CM 030-L1

End options:

Plain ends CM
 Squared-shim ends CMS

Material option:

Carbon Steel (blank)
 Stainless Steel -S17

¹ Use "CM" prefix for plain ends, Use "CMS" prefix for squared-shim ends.

² Add suffix "-S17" for 17-7 stainless steel.

³ Reference dimension.

⁴ Theoretical dimension; measured in N/mm.

⁵ See pages 134-135 for How to Order.

Stock Items in carbon steel and 17-7 PH stainless steel.

Smalley Part Number ^{1,2,5}	Operates in Bore Diameter	Clears Shaft Diameter	Load (lb)	Work Height	Free Height ³	Number of Waves	Number of Turns	Thickness	Radial Wall	Spring Rate ⁴
C025-L1*	0,250	0,150	2	0,033	0,075	2,5	3	0,006	0,024	48
C025-L2*	0,250	0,150	2	0,050	0,100	2,5	4	0,006	0,024	40
C025-L3*	0,250	0,150	2	0,060	0,125	2,5	5	0,006	0,024	31
C025-L4*	0,250	0,150	2	0,075	0,150	2,5	6	0,006	0,024	27
C025-L5*	0,250	0,150	2	0,085	0,175	2,5	7	0,006	0,024	22
C025-L6*	0,250	0,150	2	0,095	0,200	2,5	8	0,006	0,024	19
C025-L7*	0,250	0,150	2	0,120	0,225	2,5	9	0,006	0,024	19
C025-L8*	0,250	0,150	2	0,140	0,275	2,5	11	0,006	0,024	15
C025-L9*	0,250	0,150	2	0,170	0,325	2,5	13	0,006	0,024	13
C025-M1*	0,250	0,150	5	0,037	0,075	2,5	3	0,008	0,024	132
C025-M2*	0,250	0,150	5	0,048	0,100	2,5	4	0,008	0,024	96
C025-M3*	0,250	0,150	5	0,065	0,125	2,5	5	0,008	0,024	83
C025-M4*	0,250	0,150	5	0,075	0,150	2,5	6	0,008	0,024	67
C025-M5*	0,250	0,150	5	0,090	0,175	2,5	7	0,008	0,024	59
C025-M6*	0,250	0,150	5	0,100	0,200	2,5	8	0,008	0,024	50
C025-M7*	0,250	0,150	5	0,120	0,225	2,5	9	0,008	0,024	48
C025-M8*	0,250	0,150	5	0,148	0,275	2,5	11	0,008	0,024	39
C025-M9*	0,250	0,150	5	0,175	0,325	2,5	13	0,008	0,024	33
C031-L1	0,312	0,200	3	0,070	0,114	2,5	3	0,008	0,032	68
C031-L2	0,312	0,200	3	0,096	0,152	2,5	4	0,008	0,032	54
C031-L3	0,312	0,200	3	0,118	0,190	2,5	5	0,008	0,032	42
C031-L4	0,312	0,200	3	0,145	0,228	2,5	6	0,008	0,032	36
C031-L5	0,312	0,200	3	0,165	0,266	2,5	7	0,008	0,032	30
C031-L6	0,312	0,200	3	0,195	0,304	2,5	8	0,008	0,032	28
C031-L7	0,312	0,200	3	0,215	0,342	2,5	9	0,008	0,032	24
C031-L8	0,312	0,200	3	0,262	0,418	2,5	11	0,008	0,032	19
C031-L9	0,312	0,200	3	0,309	0,494	2,5	13	0,008	0,032	16
C031-M1	0,312	0,200	6	0,072	0,114	2,5	3	0,010	0,032	143
C031-M2	0,312	0,200	6	0,096	0,152	2,5	4	0,010	0,032	107
C031-M3	0,312	0,200	6	0,123	0,190	2,5	5	0,010	0,032	90
C031-M4	0,312	0,200	6	0,144	0,228	2,5	6	0,010	0,032	71
C031-M5	0,312	0,200	6	0,176	0,266	2,5	7	0,010	0,032	67
C031-M6	0,312	0,200	6	0,197	0,304	2,5	8	0,010	0,032	56
C031-M7	0,312	0,200	6	0,227	0,342	2,5	9	0,010	0,032	52
C031-M8	0,312	0,200	6	0,278	0,418	2,5	11	0,010	0,032	43
C031-M9	0,312	0,200	6	0,336	0,494	2,5	13	0,010	0,032	38
C037-L1	0,375	0,250	4	0,062	0,150	2,5	3	0,008	0,032	45
C037-L2	0,375	0,250	4	0,098	0,200	2,5	4	0,008	0,032	39
C037-L3	0,375	0,250	4	0,108	0,250	2,5	5	0,008	0,032	28
C037-L4	0,375	0,250	4	0,135	0,300	2,5	6	0,008	0,032	24
C037-L5	0,375	0,250	4	0,150	0,350	2,5	7	0,008	0,032	20
C037-L6	0,375	0,250	4	0,184	0,400	2,5	8	0,008	0,032	19
C037-L7	0,375	0,250	4	0,195	0,450	2,5	9	0,008	0,032	16
C037-L8	0,375	0,250	4	0,228	0,500	2,5	10	0,008	0,032	15
C037-L9	0,375	0,250	4	0,240	0,550	2,5	11	0,008	0,032	13
C037-M1	0,375	0,250	7	0,081	0,150	2,5	3	0,011	0,032	101
C037-M2	0,375	0,250	7	0,119	0,200	2,5	4	0,011	0,032	86
C037-M3	0,375	0,250	7	0,145	0,250	2,5	5	0,011	0,032	67
C037-M4	0,375	0,250	7	0,180	0,300	2,5	6	0,011	0,032	58
C037-M5	0,375	0,250	7	0,202	0,350	2,5	7	0,011	0,032	47
C037-M6	0,375	0,250	7	0,240	0,400	2,5	8	0,011	0,032	44
C037-M7	0,375	0,250	7	0,262	0,450	2,5	9	0,011	0,032	37
C037-M8	0,375	0,250	7	0,298	0,500	2,5	10	0,011	0,032	35
C037-M9	0,375	0,250	7	0,327	0,550	2,5	11	0,011	0,032	31



Product Dimensions

All dimensions in inches unless otherwise specified.

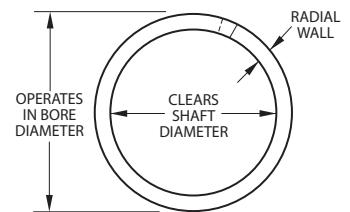

Plain Ends

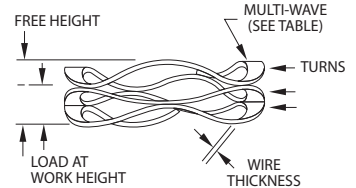

Shim Ends

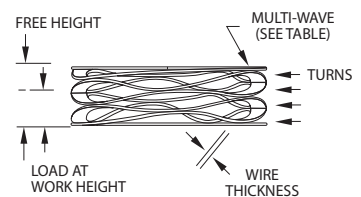

¹ Use "C" prefix for plain ends. Use "CS" prefix for squared-shim ends.

² Add suffix "-S17" for 17-7 stainless steel.

³ Reference dimension.

⁴ Theoretical dimension; measured in lb/in.

⁵ See See pages 134-135 for How to Order.

*Not available with shim ends

Order Options

C037-L1

End options:

Plain ends **C**
 Squared-shim ends. **CS**

Material option:

Carbon Steel **(blank)**
 Stainless Steel **-S17**



Stock Items in carbon steel and 17-7 PH stainless steel.

Smalley Part Number ^{1,2,5}	Operates in Bore Diameter	Clears Shaft Diameter	Load (lb)	Work Height	Free Height ³	Number of Waves	Number of Turns	Thickness	Radial Wall	Spring Rate ⁴
C043-L1	0,437	0,281	4	0,063	0,165	2,5	3	0,008	0,040	39
C043-L2	0,437	0,281	4	0,093	0,220	2,5	4	0,008	0,040	31
C043-L3	0,437	0,281	4	0,109	0,275	2,5	5	0,008	0,040	24
C043-L4	0,437	0,281	4	0,143	0,330	2,5	6	0,008	0,040	21
C043-L5	0,437	0,281	4	0,160	0,385	2,5	7	0,008	0,040	18
C043-L6	0,437	0,281	4	0,195	0,440	2,5	8	0,008	0,040	16
C043-L7	0,437	0,281	4	0,210	0,495	2,5	9	0,008	0,040	14
C043-L8	0,437	0,281	4	0,240	0,550	2,5	10	0,008	0,040	13
C043-L9	0,437	0,281	4	0,260	0,605	2,5	11	0,008	0,040	12
C043-M1	0,437	0,281	8	0,082	0,165	2,5	3	0,011	0,046	96
C043-M2	0,437	0,281	8	0,115	0,220	2,5	4	0,011	0,046	76
C043-M3	0,437	0,281	8	0,142	0,275	2,5	5	0,011	0,046	60
C043-M4	0,437	0,281	8	0,179	0,330	2,5	6	0,011	0,046	53
C043-M5	0,437	0,281	8	0,198	0,385	2,5	7	0,011	0,046	43
C043-M6	0,437	0,281	8	0,231	0,440	2,5	8	0,011	0,046	38
C043-M7	0,437	0,281	8	0,255	0,495	2,5	9	0,011	0,046	33
C043-M8	0,437	0,281	8	0,290	0,550	2,5	10	0,011	0,046	31
C043-M9	0,437	0,281	8	0,319	0,605	2,5	11	0,011	0,046	28
C050-L1	0,500	0,312	5	0,062	0,180	2,5	3	0,008	0,056	42
C050-L2	0,500	0,312	5	0,090	0,240	2,5	4	0,008	0,056	33
C050-L3	0,500	0,312	5	0,107	0,300	2,5	5	0,008	0,056	26
C050-L4	0,500	0,312	5	0,136	0,360	2,5	6	0,008	0,056	22
C050-L5	0,500	0,312	5	0,150	0,420	2,5	7	0,008	0,056	19
C050-L6	0,500	0,312	5	0,180	0,480	2,5	8	0,008	0,056	17
C050-L7	0,500	0,312	5	0,195	0,540	2,5	9	0,008	0,056	14
C050-L8	0,500	0,312	5	0,220	0,600	2,5	10	0,008	0,056	13
C050-L9	0,500	0,312	5	0,240	0,660	2,5	11	0,008	0,056	12
C050-M1	0,500	0,312	10	0,065	0,180	2,5	3	0,010	0,058	87
C050-M2	0,500	0,312	10	0,092	0,240	2,5	4	0,010	0,058	68
C050-M3	0,500	0,312	10	0,114	0,300	2,5	5	0,010	0,058	54
C050-M4	0,500	0,312	10	0,147	0,360	2,5	6	0,010	0,058	47
C050-M5	0,500	0,312	10	0,162	0,420	2,5	7	0,010	0,058	39
C050-M6	0,500	0,312	10	0,196	0,480	2,5	8	0,010	0,058	35
C050-M7	0,500	0,312	10	0,207	0,540	2,5	9	0,010	0,058	30
C050-M8	0,500	0,312	10	0,246	0,600	2,5	10	0,010	0,058	28
C050-M9	0,500	0,312	10	0,264	0,660	2,5	11	0,010	0,058	25
C050-H1	0,500	0,312	15	0,075	0,180	2,5	3	0,012	0,060	143
C050-H2	0,500	0,312	15	0,110	0,240	2,5	4	0,012	0,060	115
C050-H3	0,500	0,312	15	0,136	0,300	2,5	5	0,012	0,060	91
C050-H4	0,500	0,312	15	0,167	0,360	2,5	6	0,012	0,060	78
C050-H5	0,500	0,312	15	0,182	0,420	2,5	7	0,012	0,060	63
C050-H6	0,500	0,312	15	0,216	0,480	2,5	8	0,012	0,060	57
C050-H7	0,500	0,312	15	0,240	0,540	2,5	9	0,012	0,060	50
C050-H8	0,500	0,312	15	0,280	0,600	2,5	10	0,012	0,060	47
C050-H9	0,500	0,312	15	0,312	0,660	2,5	11	0,012	0,060	43
C056-L1	0,562	0,375	5	0,080	0,195	2,5	3	0,009	0,058	43
C056-L2	0,562	0,375	5	0,125	0,260	2,5	4	0,009	0,058	37
C056-L3	0,562	0,375	5	0,135	0,325	2,5	5	0,009	0,058	26
C056-L4	0,562	0,375	5	0,180	0,390	2,5	6	0,009	0,058	24
C056-L5	0,562	0,375	5	0,190	0,455	2,5	7	0,009	0,058	19
C056-L6	0,562	0,375	5	0,230	0,520	2,5	8	0,009	0,058	17
C056-L7	0,562	0,375	5	0,260	0,585	2,5	9	0,009	0,058	15
C056-L8	0,562	0,375	5	0,285	0,650	2,5	10	0,009	0,058	14
C056-L9	0,562	0,375	5	0,315	0,715	2,5	11	0,009	0,058	13

Product Dimensions

All dimensions in inches unless otherwise specified.

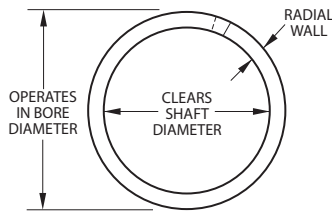

Plain Ends

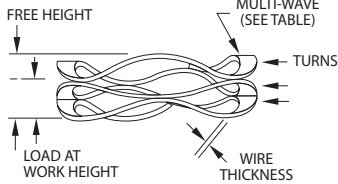

Shim Ends

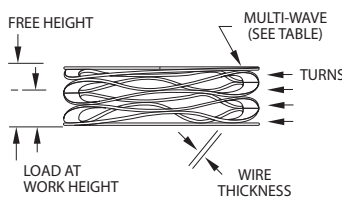

Order Options

C037-L1

End options:

Plain ends **C**
 Squared-shim ends. **CS**

Material option:

Carbon Steel **(blank)**
 Stainless Steel **-S17**

¹ Use "C" prefix for plain ends. Use "CS" prefix for squared-shim ends.

² Add suffix "-S17" for 17-7 stainless steel.

³ Reference dimension.

⁴ Theoretical dimension; measured in lb/in.

⁵ See pages 134-135 for How to Order.

⁶ 1 lb = 4,448 N

1 inch = 25,4 mm

Stock Items in carbon steel and 17-7 PH stainless steel.

Smalley Part Number ^{1,2,5}	Operates in Bore Diameter	Clears Shaft Diameter	Load (lb)	Work Height	Free Height ³	Number of Waves	Number of Turns	Thickness	Radial Wall	Spring Rate ⁴
C056-M1	0,562	0,375	11	0,086	0,195	2,5	3	0,012	0,060	101
C056-M2	0,562	0,375	11	0,123	0,260	2,5	4	0,012	0,060	80
C056-M3	0,562	0,375	11	0,145	0,325	2,5	5	0,012	0,060	61
C056-M4	0,562	0,375	11	0,187	0,390	2,5	6	0,012	0,060	54
C056-M5	0,562	0,375	11	0,209	0,455	2,5	7	0,012	0,060	45
C056-M6	0,562	0,375	11	0,253	0,520	2,5	8	0,012	0,060	41
C056-M7	0,562	0,375	11	0,273	0,585	2,5	9	0,012	0,060	35
C056-M8	0,562	0,375	11	0,318	0,650	2,5	10	0,012	0,060	33
C056-M9	0,562	0,375	11	0,343	0,715	2,5	11	0,012	0,060	30
C056-H1	0,562	0,375	18	0,093	0,195	2,5	3	0,015	0,060	176
C056-H2	0,562	0,375	18	0,136	0,260	2,5	4	0,015	0,060	145
C056-H3	0,562	0,375	18	0,165	0,325	2,5	5	0,015	0,060	113
C056-H4	0,562	0,375	18	0,212	0,390	2,5	6	0,015	0,060	101
C056-H5	0,562	0,375	18	0,245	0,455	2,5	7	0,015	0,060	86
C056-H6	0,562	0,375	18	0,282	0,520	2,5	8	0,015	0,060	76
C056-H7	0,562	0,375	18	0,323	0,585	2,5	9	0,015	0,060	69
C056-H8	0,562	0,375	18	0,360	0,650	2,5	10	0,015	0,060	62
C056-H9	0,562	0,375	18	0,408	0,715	2,5	11	0,015	0,060	59
C062-L1	0,625	0,450	6	0,055	0,180	2,5	3	0,010	0,058	48
C062-L2	0,625	0,450	6	0,068	0,240	2,5	4	0,010	0,058	35
C062-L3	0,625	0,450	6	0,085	0,300	2,5	5	0,010	0,058	28
C062-L4	0,625	0,450	6	0,106	0,360	2,5	6	0,010	0,058	24
C062-L5	0,625	0,450	6	0,128	0,420	2,5	7	0,010	0,058	21
C062-L6	0,625	0,450	6	0,165	0,540	2,5	9	0,010	0,058	16
C062-L7	0,625	0,450	6	0,202	0,660	2,5	11	0,010	0,058	13
C062-L8	0,625	0,450	6	0,238	0,780	2,5	13	0,010	0,058	11
C062-M1	0,625	0,450	12	0,104	0,180	3,5	3	0,010	0,058	158
C062-M2	0,625	0,450	12	0,130	0,240	3,5	4	0,010	0,058	109
C062-M3	0,625	0,450	12	0,175	0,300	3,5	5	0,010	0,058	96
C062-M4	0,625	0,450	12	0,206	0,360	3,5	6	0,010	0,058	78
C062-M5	0,625	0,450	12	0,246	0,420	3,5	7	0,010	0,058	69
C062-M6	0,625	0,450	12	0,317	0,540	3,5	9	0,010	0,058	54
C062-M7	0,625	0,450	12	0,386	0,660	3,5	11	0,010	0,058	44
C062-M8	0,625	0,450	12	0,454	0,780	3,5	13	0,010	0,058	37
C062-H1	0,625	0,450	20	0,102	0,180	3,5	3	0,012	0,060	256
C062-H2	0,625	0,450	20	0,135	0,240	3,5	4	0,012	0,060	190
C062-H3	0,625	0,450	20	0,175	0,300	3,5	5	0,012	0,060	160
C062-H4	0,625	0,450	20	0,205	0,360	3,5	6	0,012	0,060	129
C062-H5	0,625	0,450	20	0,245	0,420	3,5	7	0,012	0,060	114
C062-H6	0,625	0,450	20	0,315	0,540	3,5	9	0,012	0,060	89
C062-H7	0,625	0,450	20	0,390	0,660	3,5	11	0,012	0,060	74
C062-H8	0,625	0,450	20	0,465	0,780	3,5	13	0,012	0,060	63
C075-L1	0,750	0,550	7	0,142	0,250	3,5	3	0,008	0,071	65
C075-L2	0,750	0,550	7	0,187	0,333	3,5	4	0,008	0,071	48
C075-L3	0,750	0,550	7	0,246	0,417	3,5	5	0,008	0,071	41
C075-L4	0,750	0,550	7	0,285	0,500	3,5	6	0,008	0,071	33
C075-L5	0,750	0,550	7	0,348	0,583	3,5	7	0,008	0,071	30
C075-L6	0,750	0,550	7	0,446	0,750	3,5	9	0,008	0,071	23
C075-L7	0,750	0,550	7	0,580	1,000	3,5	12	0,008	0,071	17
C075-M1	0,750	0,550	13	0,159	0,250	3,5	3	0,010	0,078	143
C075-M2	0,750	0,550	13	0,203	0,333	3,5	4	0,010	0,078	100
C075-M3	0,750	0,550	13	0,270	0,417	3,5	5	0,010	0,078	88
C075-M4	0,750	0,550	13	0,314	0,500	3,5	6	0,010	0,078	70
C075-M5	0,750	0,550	13	0,381	0,583	3,5	7	0,010	0,078	64
C075-M6	0,750	0,550	13	0,489	0,750	3,5	9	0,010	0,078	50
C075-M7	0,750	0,550	13	0,649	1,000	3,5	12	0,010	0,078	37
C075-H1	0,750	0,550	22	0,169	0,250	3,5	3	0,013	0,079	272
C075-H2	0,750	0,550	22	0,215	0,333	3,5	4	0,013	0,079	186
C075-H3	0,750	0,550	22	0,291	0,417	3,5	5	0,013	0,079	175
C075-H4	0,750	0,550	22	0,335	0,500	3,5	6	0,013	0,079	133
C075-H5	0,750	0,550	22	0,405	0,583	3,5	7	0,013	0,079	124
C075-H6	0,750	0,550	22	0,526	0,750	3,5	9	0,013	0,079	98
C075-H7	0,750	0,550	22	0,699	1,000	3,5	12	0,013	0,079	73

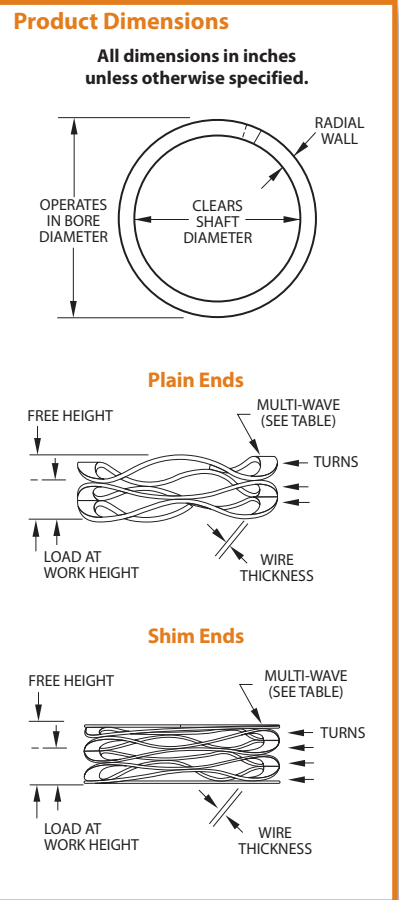

Order Options

C037-L1

End options:
 Plain ends C
 Squared-shim ends. CS

Material option:
 Carbon Steel (blank)
 Stainless Steel -S17

¹ Use "C" prefix for plain ends. Use "CS" prefix for squared-shim ends.
² Add suffix "-S17" for 17-7 stainless steel.
³ Reference dimension.
⁴ Theoretical dimension; measured in lb/in.
⁵ See pages 134-135 for How to Order.
⁶ 1 lb = 4,448 N
 1 inch = 25,4 mm



Stock Items in carbon steel and 17-7 PH stainless steel.

Smalley Part Number ^{1,2,5}	Operates in Bore Diameter	Clears Shaft Diameter	Load (lb)	Work Height	Free Height ³	Number of Waves	Number of Turns	Thickness	Radial Wall	Spring Rate ⁴
C087-L1	0,875	0,600	12	0,117	0,250	3,5	3	0,010	0,086	90
C087-L2	0,875	0,600	12	0,158	0,333	3,5	4	0,010	0,086	69
C087-L3	0,875	0,600	12	0,207	0,417	3,5	5	0,010	0,086	57
C087-L4	0,875	0,600	12	0,242	0,500	3,5	6	0,010	0,086	47
C087-L5	0,875	0,600	12	0,287	0,583	3,5	7	0,010	0,086	41
C087-L6	0,875	0,600	12	0,378	0,750	3,5	9	0,010	0,086	32
C087-L7	0,875	0,600	12	0,498	1,000	3,5	12	0,010	0,086	24
C087-M1	0,875	0,600	18	0,124	0,250	3,5	3	0,012	0,094	148
C087-M2	0,875	0,600	18	0,164	0,333	3,5	4	0,012	0,094	108
C087-M3	0,875	0,600	18	0,214	0,417	3,5	5	0,012	0,094	89
C087-M4	0,875	0,600	18	0,252	0,500	3,5	6	0,012	0,094	76
C087-M5	0,875	0,600	18	0,296	0,583	3,5	7	0,012	0,094	66
C087-M6	0,875	0,600	18	0,385	0,750	3,5	9	0,012	0,094	50
C087-M7	0,875	0,600	18	0,509	1,000	3,5	12	0,012	0,094	38
C087-H1	0,875	0,600	25	0,166	0,250	3,5	3	0,015	0,094	298
C087-H2	0,875	0,600	25	0,214	0,333	3,5	4	0,015	0,094	210
C087-H3	0,875	0,600	25	0,278	0,417	3,5	5	0,015	0,094	180
C087-H4	0,875	0,600	25	0,327	0,500	3,5	6	0,015	0,094	145
C087-H5	0,875	0,600	25	0,395	0,583	3,5	7	0,015	0,094	133
C087-H6	0,875	0,600	25	0,510	0,750	3,5	9	0,015	0,094	104
C087-H7	0,875	0,600	25	0,670	1,000	3,5	12	0,015	0,094	78
C100-L1	1,000	0,730	12	0,084	0,250	3,5	3	0,010	0,086	72
C100-L2	1,000	0,730	12	0,108	0,333	3,5	4	0,010	0,086	53
C100-L3	1,000	0,730	12	0,145	0,417	3,5	5	0,010	0,086	44
C100-L4	1,000	0,730	12	0,165	0,500	3,5	6	0,010	0,086	36
C100-L5	1,000	0,730	12	0,201	0,583	3,5	7	0,010	0,086	31
C100-L6	1,000	0,730	12	0,258	0,750	3,5	9	0,010	0,086	24
C100-L7	1,000	0,730	12	0,342	1,000	3,5	12	0,010	0,086	18
C100-L8	1,000	0,730	12	0,445	1,250	3,5	15	0,010	0,086	15
C100-L9	1,000	0,730	12	0,519	1,500	3,5	18	0,010	0,086	12
C100-L10	1,000	0,730	12	0,633	1,750	3,5	21	0,010	0,086	11
C100-L11	1,000	0,730	12	0,710	2,000	3,5	24	0,010	0,086	9
C100-M1	1,000	0,730	18	0,087	0,250	3,5	3	0,012	0,094	110
C100-M2	1,000	0,730	18	0,113	0,333	3,5	4	0,012	0,094	82
C100-M3	1,000	0,730	18	0,148	0,417	3,5	5	0,012	0,094	67
C100-M4	1,000	0,730	18	0,175	0,500	3,5	6	0,012	0,094	55
C100-M5	1,000	0,730	18	0,212	0,583	3,5	7	0,012	0,094	49
C100-M6	1,000	0,730	18	0,276	0,750	3,5	9	0,012	0,094	38
C100-M7	1,000	0,730	18	0,360	1,000	3,5	12	0,012	0,094	28
C100-M8	1,000	0,730	18	0,452	1,250	3,5	15	0,012	0,094	23
C100-M9	1,000	0,730	18	0,549	1,500	3,5	18	0,012	0,094	19
C100-M10	1,000	0,730	18	0,650	1,750	3,5	21	0,012	0,094	16
C100-M11	1,000	0,730	18	0,720	2,000	3,5	24	0,012	0,094	14
C100-H1	1,000	0,730	25	0,131	0,250	3,5	3	0,015	0,094	210
C100-H2	1,000	0,730	25	0,174	0,333	3,5	4	0,015	0,094	157
C100-H3	1,000	0,730	25	0,227	0,417	3,5	5	0,015	0,094	132
C100-H4	1,000	0,730	25	0,266	0,500	3,5	6	0,015	0,094	107
C100-H5	1,000	0,730	25	0,319	0,583	3,5	7	0,015	0,094	95
C100-H6	1,000	0,730	25	0,406	0,750	3,5	9	0,015	0,094	73
C100-H7	1,000	0,730	25	0,541	1,000	3,5	12	0,015	0,094	54
C100-H8	1,000	0,730	25	0,688	1,250	3,5	15	0,015	0,094	45
C100-H9	1,000	0,730	25	0,813	1,500	3,5	18	0,015	0,094	36
C100-H10	1,000	0,730	25	0,957	1,750	3,5	21	0,015	0,094	32
C100-H11	1,000	0,730	25	1,083	2,000	3,5	24	0,015	0,094	27

Product Dimensions

All dimensions in inches unless otherwise specified.

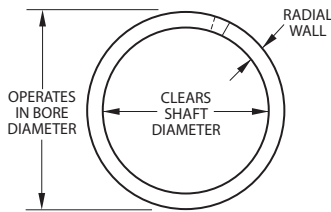

Plain Ends

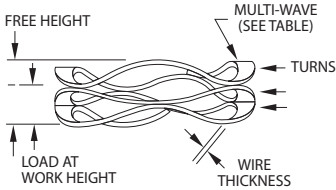

Shim Ends

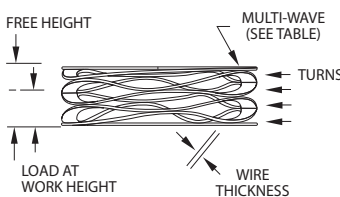

Order Options

C037-L1

End options:

Plain ends **C**
 Squared-shim ends. **CS**

Material option:

Carbon Steel **(blank)**
 Stainless Steel **-S17**

¹ Use "C" prefix for plain ends. Use "CS" prefix for squared-shim ends.

² Add suffix "-S17" for 17-7 stainless steel.

³ Reference dimension.

⁴ Theoretical dimension; measured in lb/in.

⁵ See pages 134-135 for How to Order.

⁶ 1 lb = 4,448 N

1 inch = 25,4 mm

Stock Items in carbon steel and 17-7 PH stainless steel.

Smalley Part Number ^{1,2,5}	Operates in Bore Diameter	Clears Shaft Diameter	Load (lb)	Work Height	Free Height ³	Number of Waves	Number of Turns	Thickness	Radial Wall	Spring Rate ⁴
C112-L1	1,125	0,850	12	0,146	0,300	3,5	3	0,012	0,094	78
C112-L2	1,125	0,850	12	0,186	0,400	3,5	4	0,012	0,094	56
C112-L3	1,125	0,850	12	0,250	0,500	3,5	5	0,012	0,094	48
C112-L4	1,125	0,850	12	0,295	0,600	3,5	6	0,012	0,094	39
C112-L5	1,125	0,850	12	0,344	0,700	3,5	7	0,012	0,094	34
C112-L6	1,125	0,850	12	0,392	0,800	3,5	8	0,012	0,094	29
C112-L7	1,125	0,850	12	0,488	1,000	3,5	10	0,012	0,094	23
C112-L8	1,125	0,850	12	0,659	1,300	3,5	13	0,012	0,094	19
C112-L9	1,125	0,850	12	0,807	1,600	3,5	16	0,012	0,094	15
C112-L10	1,125	0,850	12	1,017	2,000	3,5	20	0,012	0,094	12
C112-M1	1,125	0,850	20	0,160	0,300	3,5	3	0,015	0,094	143
C112-M2	1,125	0,850	20	0,202	0,400	3,5	4	0,015	0,094	101
C112-M3	1,125	0,850	20	0,270	0,500	3,5	5	0,015	0,094	87
C112-M4	1,125	0,850	20	0,318	0,600	3,5	6	0,015	0,094	71
C112-M5	1,125	0,850	20	0,381	0,700	3,5	7	0,015	0,094	63
C112-M6	1,125	0,850	20	0,427	0,800	3,5	8	0,015	0,094	54
C112-M7	1,125	0,850	20	0,536	1,000	3,5	10	0,015	0,094	43
C112-M8	1,125	0,850	20	0,708	1,300	3,5	13	0,015	0,094	34
C112-M9	1,125	0,850	20	0,861	1,600	3,5	16	0,015	0,094	27
C112-M10	1,125	0,850	20	1,088	2,000	3,5	20	0,015	0,094	22
C112-H1	1,125	0,850	30	0,178	0,300	3,5	3	0,018	0,094	246
C112-H2	1,125	0,850	30	0,229	0,400	3,5	4	0,018	0,094	175
C112-H3	1,125	0,850	30	0,303	0,500	3,5	5	0,018	0,094	152
C112-H4	1,125	0,850	30	0,350	0,600	3,5	6	0,018	0,094	120
C112-H5	1,125	0,850	30	0,421	0,700	3,5	7	0,018	0,094	108
C112-H6	1,125	0,850	30	0,470	0,800	3,5	8	0,018	0,094	91
C112-H7	1,125	0,850	30	0,593	1,000	3,5	10	0,018	0,094	74
C112-H8	1,125	0,850	30	0,787	1,300	3,5	13	0,018	0,094	58
C112-H9	1,125	0,850	30	0,956	1,600	3,5	16	0,018	0,094	47
C112-H10	1,125	0,850	30	1,202	2,000	3,5	20	0,018	0,094	38
C125-L1	1,250	1,000	12	0,084	0,300	3,5	3	0,012	0,094	56
C125-L2	1,250	1,000	12	0,113	0,400	3,5	4	0,012	0,094	42
C125-L3	1,250	1,000	12	0,149	0,500	3,5	5	0,012	0,094	34
C125-L4	1,250	1,000	12	0,172	0,600	3,5	6	0,012	0,094	28
C125-L5	1,250	1,000	12	0,207	0,700	3,5	7	0,012	0,094	24
C125-L6	1,250	1,000	12	0,227	0,800	3,5	8	0,012	0,094	21
C125-L7	1,250	1,000	12	0,301	1,000	3,5	10	0,012	0,094	17
C125-L8	1,250	1,000	12	0,395	1,300	3,5	13	0,012	0,094	13
C125-L9	1,250	1,000	12	0,467	1,600	3,5	16	0,012	0,094	11
C125-L10	1,250	1,000	12	0,591	2,000	3,5	20	0,012	0,094	9
C125-M1	1,250	1,000	20	0,124	0,300	3,5	3	0,015	0,094	114
C125-M2	1,250	1,000	20	0,165	0,400	3,5	4	0,015	0,094	85
C125-M3	1,250	1,000	20	0,215	0,500	3,5	5	0,015	0,094	70
C125-M4	1,250	1,000	20	0,253	0,600	3,5	6	0,015	0,094	58
C125-M5	1,250	1,000	20	0,303	0,700	3,5	7	0,015	0,094	50
C125-M6	1,250	1,000	20	0,341	0,800	3,5	8	0,015	0,094	44
C125-M7	1,250	1,000	20	0,427	1,000	3,5	10	0,015	0,094	35
C125-M8	1,250	1,000	20	0,577	1,300	3,5	13	0,015	0,094	28
C125-M9	1,250	1,000	20	0,692	1,600	3,5	16	0,015	0,094	22
C125-M10	1,250	1,000	20	0,866	2,000	3,5	20	0,015	0,094	18
C125-H1	1,250	1,000	30	0,158	0,300	3,5	3	0,019	0,094	210
C125-H2	1,250	1,000	30	0,210	0,400	3,5	4	0,019	0,094	158
C125-H3	1,250	1,000	30	0,272	0,500	3,5	5	0,019	0,094	132
C125-H4	1,250	1,000	30	0,320	0,600	3,5	6	0,019	0,094	107
C125-H5	1,250	1,000	30	0,384	0,700	3,5	7	0,019	0,094	95
C125-H6	1,250	1,000	30	0,433	0,800	3,5	8	0,019	0,094	82
C125-H7	1,250	1,000	30	0,538	1,000	3,5	10	0,019	0,094	65
C125-H8	1,250	1,000	30	0,717	1,300	3,5	13	0,019	0,094	51
C125-H9	1,250	1,000	30	0,878	1,600	3,5	16	0,019	0,094	42
C125-H10	1,250	1,000	30	1,103	2,000	3,5	20	0,019	0,094	33



Product Dimensions

All dimensions in inches unless otherwise specified.

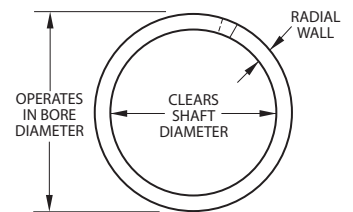

Plain Ends

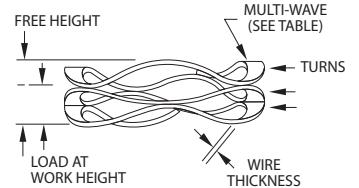

Shim Ends

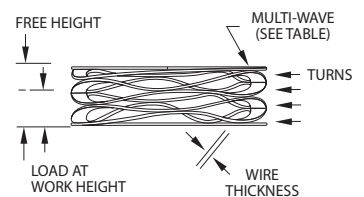

Order Options

C037-L1

End options:
 Plain ends **C**
 Squared-shim ends **CS**

Material option:
 Carbon Steel **(blank)**
 Stainless Steel **-S17**

¹ Use "C" prefix for plain ends. Use "CS" prefix for squared-shim ends.

² Add suffix "-S17" for 17-7 stainless steel.

³ Reference dimension.

⁴ Theoretical dimension; measured in lb/in.

⁵ See pages 134-135 for How to Order.

⁶ 1 lb = 4,448 N

1 inch = 25,4 mm



Stock Items in carbon steel and 17-7 PH stainless steel.

Smalley Part Number ^{1,2,5}	Operates in Bore Diameter	Clears Shaft Diameter	Load (lb)	Work Height	Free Height ³	Number of Waves	Number of Turns	Thickness	Radial Wall	Spring Rate ⁴
C137-L1	1,375	1,030	15	0,075	0,300	3,5	3	0,012	0,122	67
C137-L2	1,375	1,030	15	0,099	0,400	3,5	4	0,012	0,122	50
C137-L3	1,375	1,030	15	0,129	0,500	3,5	5	0,012	0,122	40
C137-L4	1,375	1,030	15	0,155	0,600	3,5	6	0,012	0,122	34
C137-L5	1,375	1,030	15	0,179	0,700	3,5	7	0,012	0,122	29
C137-L6	1,375	1,030	15	0,206	0,800	3,5	8	0,012	0,122	25
C137-L7	1,375	1,030	15	0,256	1,000	3,5	10	0,012	0,122	20
C137-L8	1,375	1,030	15	0,341	1,300	3,5	13	0,012	0,122	16
C137-L9	1,375	1,030	15	0,424	1,600	3,5	16	0,012	0,122	13
C137-L10	1,375	1,030	15	0,530	2,000	3,5	20	0,012	0,122	10
C137-M1	1,375	1,030	25	0,142	0,300	3,5	3	0,016	0,133	158
C137-M2	1,375	1,030	25	0,186	0,400	3,5	4	0,016	0,133	117
C137-M3	1,375	1,030	25	0,240	0,500	3,5	5	0,016	0,133	96
C137-M4	1,375	1,030	25	0,281	0,600	3,5	6	0,016	0,133	78
C137-M5	1,375	1,030	25	0,340	0,700	3,5	7	0,016	0,133	69
C137-M6	1,375	1,030	25	0,384	0,800	3,5	8	0,016	0,133	60
C137-M7	1,375	1,030	25	0,486	1,000	3,5	10	0,016	0,133	49
C137-M8	1,375	1,030	25	0,632	1,300	3,5	13	0,016	0,133	37
C137-M9	1,375	1,030	25	0,788	1,600	3,5	16	0,016	0,133	31
C137-M10	1,375	1,030	25	0,982	2,000	3,5	20	0,016	0,133	25
C137-H1	1,375	1,030	35	0,149	0,300	3,5	3	0,018	0,133	232
C137-H2	1,375	1,030	35	0,189	0,400	3,5	4	0,018	0,133	166
C137-H3	1,375	1,030	35	0,247	0,500	3,5	5	0,018	0,133	138
C137-H4	1,375	1,030	35	0,287	0,600	3,5	6	0,018	0,133	112
C137-H5	1,375	1,030	35	0,343	0,700	3,5	7	0,018	0,133	98
C137-H6	1,375	1,030	35	0,390	0,800	3,5	8	0,018	0,133	85
C137-H7	1,375	1,030	35	0,490	1,000	3,5	10	0,018	0,133	69
C137-H8	1,375	1,030	35	0,646	1,300	3,5	13	0,018	0,133	54
C137-H9	1,375	1,030	35	0,793	1,600	3,5	16	0,018	0,133	43
C137-H10	1,375	1,030	35	1,000	2,000	3,5	20	0,018	0,133	35
C150-L1	1,500	1,140	20	0,129	0,300	3,5	3	0,016	0,133	117
C150-L2	1,500	1,140	20	0,164	0,400	3,5	4	0,016	0,133	85
C150-L3	1,500	1,140	20	0,213	0,500	3,5	5	0,016	0,133	70
C150-L4	1,500	1,140	20	0,247	0,600	3,5	6	0,016	0,133	57
C150-L5	1,500	1,140	20	0,301	0,700	3,5	7	0,016	0,133	50
C150-L6	1,500	1,140	20	0,337	0,800	3,5	8	0,016	0,133	43
C150-L7	1,500	1,140	20	0,430	1,000	3,5	10	0,016	0,133	35
C150-L8	1,500	1,140	20	0,565	1,300	3,5	13	0,016	0,133	27
C150-L9	1,500	1,140	20	0,694	1,600	3,5	16	0,016	0,133	22
C150-L10	1,500	1,140	20	0,866	2,000	3,5	20	0,016	0,133	18
C150-M1	1,500	1,140	35	0,122	0,300	3,5	3	0,018	0,133	197
C150-M2	1,500	1,140	35	0,158	0,400	3,5	4	0,018	0,133	145
C150-M3	1,500	1,140	35	0,206	0,500	3,5	5	0,018	0,133	119
C150-M4	1,500	1,140	35	0,241	0,600	3,5	6	0,018	0,133	97
C150-M5	1,500	1,140	35	0,291	0,700	3,5	7	0,018	0,133	86
C150-M6	1,500	1,140	35	0,324	0,800	3,5	8	0,018	0,133	74
C150-M7	1,500	1,140	35	0,409	1,000	3,5	10	0,018	0,133	59
C150-M8	1,500	1,140	35	0,540	1,300	3,5	13	0,018	0,133	46
C150-M9	1,500	1,140	35	0,657	1,600	3,5	16	0,018	0,133	37
C150-M10	1,500	1,140	35	0,835	2,000	3,5	20	0,018	0,133	30
C150-H1	1,500	1,140	60	0,166	0,300	4,5	3	0,018	0,133	448
C150-H2	1,500	1,140	60	0,216	0,400	4,5	4	0,018	0,133	326
C150-H3	1,500	1,140	60	0,278	0,500	4,5	5	0,018	0,133	270
C150-H4	1,500	1,140	60	0,329	0,600	4,5	6	0,018	0,133	221
C150-H5	1,500	1,140	60	0,390	0,700	4,5	7	0,018	0,133	194
C150-H6	1,500	1,140	60	0,443	0,800	4,5	8	0,018	0,133	168
C150-H7	1,500	1,140	60	0,555	1,000	4,5	10	0,018	0,133	135
C150-H8	1,500	1,140	60	0,726	1,300	4,5	13	0,018	0,133	105
C150-H9	1,500	1,140	60	0,890	1,600	4,5	16	0,018	0,133	85
C150-H10	1,500	1,140	60	1,119	2,000	4,5	20	0,018	0,133	68

Product Dimensions

All dimensions in inches unless otherwise specified.

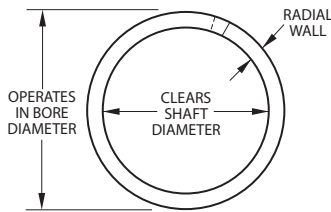

Plain Ends

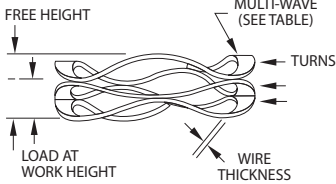

Shim Ends

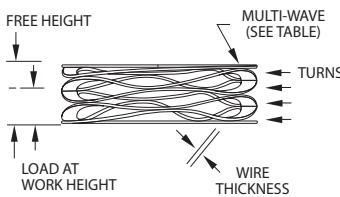

Order Options

C037-L1

End options:

Plain ends **C**
 Squared-shim ends. **CS**

Material option:

Carbon Steel (blank)
 Stainless Steel **-S17**

¹ Use "C" prefix for plain ends. Use "CS" prefix for squared-shim ends.

² Add suffix "-S17" for 17-7 stainless steel.

³ Reference dimension.

⁴ Theoretical dimension; measured in lb/in.

⁵ See pages 134-135 for How to Order.

⁶ 1 lb = 4,448 N

1 inch = 25,4 mm

Stock Items in carbon steel and 17-7 PH stainless steel.

Smalley Part Number ^{1,2,5}	Operates in Bore Diameter	Clears Shaft Diameter	Load (lb)	Work Height	Free Height ³	Number of Waves	Number of Turns	Thickness	Radial Wall	Spring Rate ⁴
C175-L1	1,750	1,340	25	0,155	0,375	3,5	3	0,018	0,143	114
C175-L2	1,750	1,340	25	0,200	0,500	3,5	4	0,018	0,143	83
C175-L3	1,750	1,340	25	0,265	0,625	3,5	5	0,018	0,143	69
C175-L4	1,750	1,340	25	0,310	0,750	3,5	6	0,018	0,143	57
C175-L5	1,750	1,340	25	0,367	0,870	3,5	7	0,018	0,143	50
C175-L6	1,750	1,340	25	0,415	1,000	3,5	8	0,018	0,143	43
C175-L7	1,750	1,340	25	0,523	1,250	3,5	10	0,018	0,143	34
C175-L8	1,750	1,340	25	0,638	1,500	3,5	12	0,018	0,143	29
C175-L9	1,750	1,340	25	0,737	1,750	3,5	14	0,018	0,143	25
C175-L10	1,750	1,340	25	0,844	2,000	3,5	16	0,018	0,143	22
C175-M1	1,750	1,340	50	0,188	0,375	4,5	3	0,018	0,143	267
C175-M2	1,750	1,340	50	0,244	0,500	4,5	4	0,018	0,143	195
C175-M3	1,750	1,340	50	0,315	0,625	4,5	5	0,018	0,143	161
C175-M4	1,750	1,340	50	0,374	0,750	4,5	6	0,018	0,143	133
C175-M5	1,750	1,340	50	0,452	0,870	4,5	7	0,018	0,143	120
C175-M6	1,750	1,340	50	0,505	1,000	4,5	8	0,018	0,143	101
C175-M7	1,750	1,340	50	0,629	1,250	4,5	10	0,018	0,143	81
C175-M8	1,750	1,340	50	0,768	1,500	4,5	12	0,018	0,143	68
C175-M9	1,750	1,340	50	0,899	1,750	4,5	14	0,018	0,143	59
C175-M10	1,750	1,340	50	1,026	2,000	4,5	16	0,018	0,143	51
C175-H1	1,750	1,340	90	0,232	0,375	4,5	3	0,024	0,148	629
C175-H2	1,750	1,340	90	0,314	0,500	4,5	4	0,024	0,148	484
C175-H3	1,750	1,340	90	0,409	0,625	4,5	5	0,024	0,148	417
C175-H4	1,750	1,340	90	0,482	0,750	4,5	6	0,024	0,148	336
C175-H5	1,750	1,340	90	0,577	0,870	4,5	7	0,024	0,148	307
C175-H6	1,750	1,340	90	0,651	1,000	4,5	8	0,024	0,148	258
C175-H7	1,750	1,340	90	0,813	1,250	4,5	10	0,024	0,148	206
C175-H8	1,750	1,340	90	0,980	1,500	4,5	12	0,024	0,148	173
C175-H9	1,750	1,340	90	1,147	1,750	4,5	14	0,024	0,148	149
C175-H10	1,750	1,340	90	1,317	2,000	4,5	16	0,024	0,148	132
C200-L1	2,000	1,600	25	0,094	0,375	3,5	3	0,018	0,143	89
C200-L2	2,000	1,600	25	0,120	0,500	3,5	4	0,018	0,143	66
C200-L3	2,000	1,600	25	0,158	0,625	3,5	5	0,018	0,143	54
C200-L4	2,000	1,600	25	0,179	0,750	3,5	6	0,018	0,143	44
C200-L5	2,000	1,600	25	0,217	0,870	3,5	7	0,018	0,143	38
C200-L6	2,000	1,600	25	0,243	1,000	3,5	8	0,018	0,143	33
C200-L7	2,000	1,600	25	0,306	1,250	3,5	10	0,018	0,143	26
C200-L8	2,000	1,600	25	0,365	1,500	3,5	12	0,018	0,143	22
C200-L9	2,000	1,600	25	0,433	1,750	3,5	14	0,018	0,143	19
C200-L10	2,000	1,600	25	0,490	2,000	3,5	16	0,018	0,143	17
C200-M1	2,000	1,600	50	0,140	0,375	4,5	3	0,018	0,143	213
C200-M2	2,000	1,600	50	0,184	0,500	4,5	4	0,018	0,143	158
C200-M3	2,000	1,600	50	0,245	0,625	4,5	5	0,018	0,143	132
C200-M4	2,000	1,600	50	0,278	0,750	4,5	6	0,018	0,143	106
C200-M5	2,000	1,600	50	0,345	0,870	4,5	7	0,018	0,143	95
C200-M6	2,000	1,600	50	0,395	1,000	4,5	8	0,018	0,143	83
C200-M7	2,000	1,600	50	0,498	1,250	4,5	10	0,018	0,143	66
C200-M8	2,000	1,600	50	0,593	1,500	4,5	12	0,018	0,143	55
C200-M9	2,000	1,600	50	0,694	1,750	4,5	14	0,018	0,143	47
C200-M10	2,000	1,600	50	0,800	2,000	4,5	16	0,018	0,143	42
C200-H1	2,000	1,600	90	0,197	0,375	4,5	3	0,024	0,148	506
C200-H2	2,000	1,600	90	0,258	0,500	4,5	4	0,024	0,148	372
C200-H3	2,000	1,600	90	0,332	0,625	4,5	5	0,024	0,148	307
C200-H4	2,000	1,600	90	0,389	0,750	4,5	6	0,024	0,148	249
C200-H5	2,000	1,600	90	0,465	0,870	4,5	7	0,024	0,148	222
C200-H6	2,000	1,600	90	0,525	1,000	4,5	8	0,024	0,148	189
C200-H7	2,000	1,600	90	0,661	1,250	4,5	10	0,024	0,148	153
C200-H8	2,000	1,600	90	0,781	1,500	4,5	12	0,024	0,148	125
C200-H9	2,000	1,600	90	0,941	1,750	4,5	14	0,024	0,148	111
C200-H10	2,000	1,600	90	1,069	2,000	4,5	16	0,024	0,148	97



Product Dimensions

All dimensions in inches unless otherwise specified.

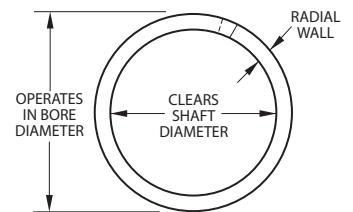

Plain Ends

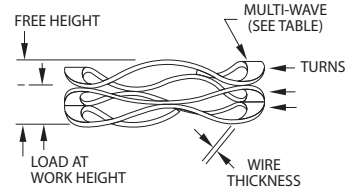

Shim Ends

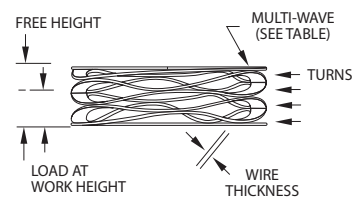

Order Options

C037-L1

End options:
 Plain ends **C**
 Squared-shim ends. **CS**

Material option:
 Carbon Steel **(blank)**
 Stainless Steel **-S17**

¹ Use "C" prefix for plain ends. Use "CS" prefix for squared-shim ends.

² Add suffix "-S17" for 17-7 stainless steel.

³ Reference dimension.

⁴ Theoretical dimension; measured in lb/in.

⁵ See pages 134-135 for How to Order.

⁶ 1 lb = 4,448 N

1 inch = 25,4 mm

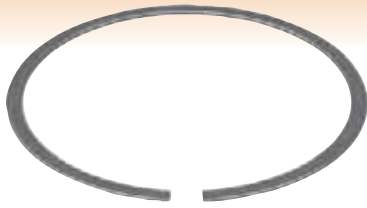

Smalley Shims are commonly used in conjunction with wave springs where a back-up plate is needed for housings made of softer metals like aluminum or bronze, and for packings made of leather, neoprene or similar materials. Shims can function as spacers to change wave spring operating heights. Adding or subtracting shims is an excellent method of adjusting load on a wave spring. Using a shim spacer can also control tolerance buildups.

Stock Items in carbon steel and 17-7 PH stainless steel. However, Smalley can make them to order in nearly any size or material.

Smalley Part Number ^{1,3}	Outside Diameter	Thickness	Radial Wall	Part Weight ²	Smalley Part Number ^{1,3}	Outside Diameter	Thickness	Radial Wall	Part Weight ²
SSRS-0075	0,750	0,024	0,093	1,31	SSRS-0550	5,500	0,030	0,233	32,77
SSRS-0087	0,875	0,024	0,093	1,55	SSRS-0562	5,625	0,030	0,233	33,54
SSRS-0100	1,000	0,024	0,103	1,97	SSRS-0575	5,750	0,030	0,233	34,32
SSRS-0112	1,125	0,024	0,138	2,91	SSRS-0587	5,875	0,030	0,233	35,10
SSRS-0125	1,250	0,024	0,138	3,28	SSRS-0600	6,000	0,030	0,233	35,88
SSRS-0137	1,375	0,024	0,138	3,65	SSRS-0612	6,125	0,030	0,233	36,66
SSRS-0150	1,500	0,024	0,150	4,33	SSRS-0625	6,250	0,030	0,233	37,43
SSRS-0162	1,625	0,024	0,150	4,73	SSRS-0637	6,375	0,030	0,233	38,21
SSRS-0175	1,750	0,024	0,150	5,13	SSRS-0650	6,500	0,030	0,233	38,99
SSRS-0187	1,875	0,024	0,150	5,53	SSRS-0675	6,750	0,030	0,233	40,54
SSRS-0200	2,000	0,024	0,150	5,93	SSRS-0700	7,000	0,032	0,375	70,76
SSRS-0212	2,125	0,024	0,150	6,33	SSRS-0725	7,250	0,032	0,375	73,43
SSRS-0225	2,250	0,024	0,150	6,73	SSRS-0750	7,500	0,032	0,375	76,10
SSRS-0237	2,375	0,024	0,178	8,35	SSRS-0775	7,750	0,032	0,375	78,77
SSRS-0250	2,500	0,024	0,178	8,83	SSRS-0800	8,000	0,032	0,375	81,44
SSRS-0262	2,625	0,024	0,178	9,30	SSRS-0825	8,250	0,032	0,375	84,11
SSRS-0275	2,750	0,030	0,188	12,86	SSRS-0850	8,500	0,032	0,375	86,78
SSRS-0287	2,875	0,030	0,188	13,49	SSRS-0875	8,750	0,032	0,375	89,45
SSRS-0300	3,000	0,030	0,188	14,12	SSRS-0900	9,000	0,032	0,375	92,12
SSRS-0312	3,125	0,030	0,188	14,74	SSRS-0950	9,500	0,032	0,375	97,46
SSRS-0325	3,250	0,030	0,233	18,77	SSRS-1000	10,000	0,032	0,375	102,80
SSRS-0337	3,375	0,030	0,233	19,55	SSRS-1050	10,500	0,032	0,375	108,14
SSRS-0350	3,500	0,030	0,233	20,32	SSRS-1100	11,000	0,032	0,375	113,48
SSRS-0362	3,625	0,030	0,233	21,10	SSRS-1150	11,500	0,032	0,375	118,82
SSRS-0375	3,750	0,030	0,233	21,88	SSRS-1200	12,000	0,032	0,375	124,16
SSRS-0387	3,875	0,030	0,233	22,66	SSRS-1250	12,500	0,032	0,375	129,50
SSRS-0400	4,000	0,030	0,233	23,44	SSRS-1300	13,000	0,032	0,375	134,84
SSRS-0412	4,125	0,030	0,233	24,21	SSRS-1350	13,500	0,032	0,375	140,18
SSRS-0425	4,250	0,030	0,233	24,99	SSRS-1400	14,000	0,032	0,375	145,52
SSRS-0437	4,375	0,030	0,233	25,77	SSRS-1450	14,500	0,032	0,375	150,86
SSRS-0450	4,500	0,030	0,233	26,55	SSRS-1500	15,000	0,032	0,375	156,20
SSRS-0462	4,625	0,030	0,233	27,32	SSRS-1550	15,500	0,032	0,375	161,54
SSRS-0475	4,750	0,030	0,233	28,10	SSRS-1600	16,000	0,032	0,375	166,88
SSRS-0487	4,875	0,030	0,233	28,88					
SSRS-0500	5,000	0,030	0,233	29,66					
SSRS-0512	5,125	0,030	0,233	30,43					
SSRS-0525	5,250	0,030	0,233	31,21					
SSRS-0537	5,375	0,030	0,233	31,99					

Product Dimensions

All dimensions in inches unless otherwise specified.

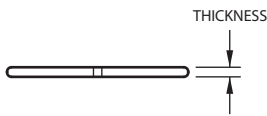
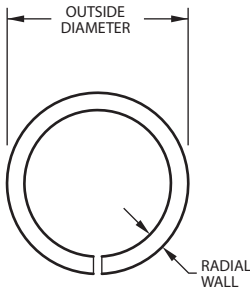

¹ Add suffix "-S17" for 17-7 stainless steel.

² Lbs. per 1000.

³ See pages 134-135 for How to Order.

⁴ 1 lb = 4,448 N

1 inch = 25,4 mm



Spring Tester

Spring Tester

Springs are inspected for load, deflection, free height and spring rate with this compression spring tester, designed and built by Smalley. Main components of the tester are described below.

The accuracy in checking spring load/deflection characteristics is dependent on the accuracy and precision of the testing device itself. The concept of accurate compression testing relies greatly on the following tester features:

1. Upper and lower plates must remain parallel throughout the test. Generally, the distance between upper and lower plates must be within 0,05 mm at any point, from zero to full load.
2. Upper and lower plates must be rigid in that they should not misalign with the spring positioned at any point on the lower plate (note that placing a spring off-center induces a moment, which tends to both tip the plates and cause frictional drag.)
3. The load system must be free of friction, which can cause hysteresis in the load values obtained in the test.
4. Testing surfaces of both the lower and upper plates must be smooth and free of scratches, cracks or other physical imperfections.

Fatigue Tester

Fatigue cycling is often a consideration when designing compression springs. Testing provides a more accurate prediction of actual cycle life and is recommended whenever cycle life is critical or when calculations show little margin over the cycle requirement.

Ideally, springs should be cycle tested in the actual assembly. Where this is not feasible, Smalley offers testing on high speed cycle machinery. The cycle test machinery can be adjusted to various work heights and stroke lengths to simulate the actual application.



Fatigue Tester

Ring Introduction

Advantages of Spirolox® Retaining Rings

Spirolox Retaining Rings have No Ears to Interfere in your assembly! Spirolox Rings are manufactured by coiling the ring from flat wire. This unique process produces a retaining ring that has no protruding ears or burrs to interfere with your assembly. Because coiling produces a retaining ring with no scrap, the Spirolox Ring can be economically produced in carbon steel, stainless steel, coppers, and many other alloys.

Smalley offers over 6000 standard parts, which are readily available in both carbon and stainless steel. If you require special designs, take advantage of Smalley's No-Tooling-Cost process; a process perfect for large runs, prototypes and midstream design changes. Whatever your application, Smalley has the cost-effective and innovative design solution.



Spirolox Retaining Rings offer many advantages over stamped retaining rings

- No gap - 360° retaining surface
- No protruding ears to interfere with mating components (uniform cross-section)
- Economically produced in stainless steel because the coiling process produces no scrap
- **No-Tooling-Charge** on special designs
- Easy installation and removal

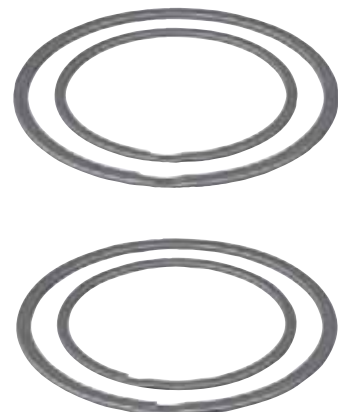

Other Ring Types & Special Designs



Constant Section Rings

Another popular choice of retaining ring configurations is the well known Constant Section Ring. Produced by edgewinding with no special tooling charges, Constant Section Rings have been specified for many years in the automotive and heavy equipment industries as a standard choice of engineers.

Smalley has hundreds of standard Constant Section Rings in stock, in carbon steel and stainless steel and in both inch and metric sizes. Special or custom designs can be produced quickly and economically utilizing Smalley's precision No-Tooling-Cost manufacturing process.

Constant Section Rings can withstand high forces and impact loads and are easily installed and removed from their internal or external groove for field servicing your product.



WAVERING®

The WaveRing is a spiral retaining ring with an axial wave form. It acts like a standard retaining ring with the additional feature of compressibility. It compensates for the overall length tolerance of stacked components, while still acting as a retaining ring. Once assembled the WaveRing will reduce looseness and vibration in the assembly.

Designed to fit into a groove, the WaveRing applies pressure in two directions: against the groove wall and against the assembly components. Single, double or multiple turns in the WaveRing are possible as well as a choice of materials, including our standard 17-7 PH stainless and carbon steel.



Special Rings

A major segment of Smalley manufacturing is in "special" or prototype retaining rings. Common Smalley specials include balanced, multi-turn (4,5,6 turns and more) and special ends in diameters from 5 mm – 3000 mm (0,200 in – 120 in)and larger. Smalley engineers are on hand to help you design a ring specific to your application. Because there are no tooling costs, no job is too big or too little. Prototypes can be quickly and economically produced to test a design; in days, not weeks.

Retaining Ring Selection Guide

1

STEP 1: Do you need to meet any specifications?
YES **NO**

Specification	Smalley Series
Military MIL- DTL-27426/3	.WH
Military MIL- DTL-27426/1	.WS
Military MIL- DTL-27426/4	.WHM
Military MIL- DTL-27426/2	.WSM
Aerospace AS4299, AS3217, AS3219	.WH
Aerospace AS4299, AS3218, AS3219	.WS
Aerospace AS4299, AS3215, AS3219	.WHM
Aerospace AS4299, AS3216, AS3219	.WSM
Metric Aerospace MA 4017	.EH
Metric Aerospace MA 4016	.ES



2

STEP 2: Do you need to match an alternative ring groove?
YES **NO**

Manufacturer	Smalley Series
Truarc N5000 & 5008	.WHM
Truarc 5100 & 5108	.WSM
Eaton NAN	.WHT
Eaton XAN	.WST
Eaton I-N	.WHM
Eaton E-N	.WSM
Industrial RR 3000 & 4000	.WHM
Industrial RR 3100 & 4100	.WSM
Anderton N1300	.WHM
Anderton N1400	.WSM
Anderton D1300	.DNH
Anderton D1400	.DNS
European Specification DIN 472	.DNH
European Specification DIN 471	.DNS



3

STEP 3A: Choose by the Thrust Capacity needed OR see step 3B

Metric Units (mm)			
Series	Load ¹	Housing	Shaft
Light Duty	18,03	VHM	VSM
DIN Series ²	36,55	DNH	DNS
Aerospace Series	38,96	EH	ES
Constant Section Rings	36,53	FH	FS

¹ Representative example shows the load capacity (kN) for a 50 mm ring.

² Manufactured to DIN groove specifications.

Standard Units (inches)			
Series	Load ¹	Housing	Shaft
Light Duty	4100	VH	VS
Medium Duty	4950	WH	WS
Medium Heavy Duty	7070	WHT	WST
Heavy Duty	8340	WHM	WSM
Constant Section Rings	8341	FHE	FSE
WaveRing	—	WHW	WSW

¹ Representative example shows the load capacity (lb) for a 2" ring.

STEP 3B: Still not sure?

Use Smalley's most popular series, Medium Duty WH (internal) or WS (external).

Ask for a free sample.

Relative proportions of rings in grooves

A cross-section of each Spirolox Retaining Ring configuration is illustrated, comparing groove and ring sections in the same diameter bore or shaft. The heavier retaining ring cross-sections are in deeper and wider grooves, to provide significantly greater thrust capacity.

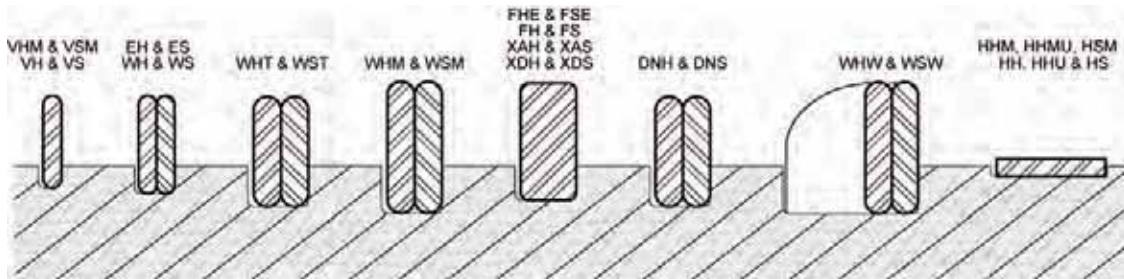

Ring Types

Spirolox Retaining Rings—Single Turn (1-Turn)

VHM & VSM — Light Duty, metric
VH & VS — Light Duty, inch

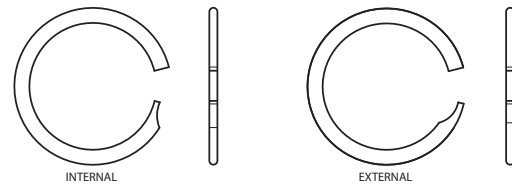

Spirolox Retaining Rings—2-Turn

EH & ES — Medium Duty, Metric Aerospace
DNH & DNS — Heavy Duty DIN, metric
WH & WS — Medium Duty, inch
WHT & WST — Medium Heavy Duty, inch
WHM & WSM — Heavy Duty, inch

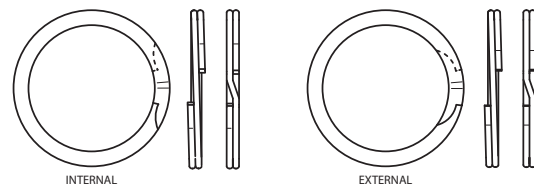

Constant Section Rings

FH & FS — Heavy Duty, metric
FHE & FSE — Heavy Duty, inch
*XAH & XAS — Eaton Style, inch
*XDH & XDS — Eaton Style, inch

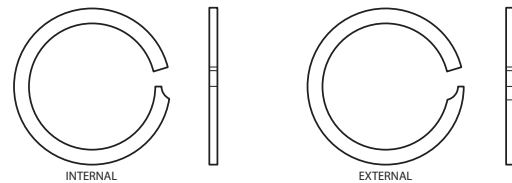

WaveRings

WHW & WSW — inch

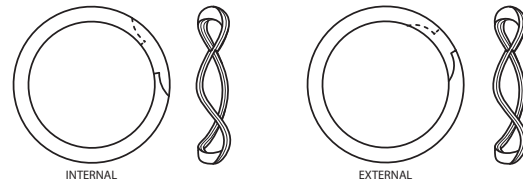

Hoopster Rings

HHM, HHMU & HSM — metric
HH, HHU & HS — inch

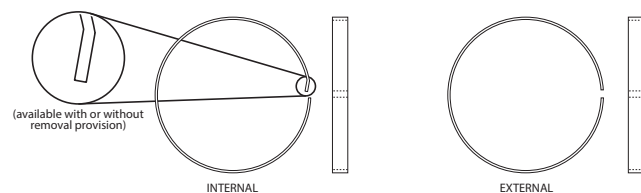

*End configurations vary by size; see page 128 for Constant Section Ring end configurations.

Selection Guide

Interchange Listing

Smalley Retaining Rings are interchangeable with both inch and metric retaining ring grooves. Smalley offers free samples of all stock retaining rings to test in your application.

Cross reference a standard stamped ring or snap ring to find the appropriate Smalley Retaining Ring to fit your application.

SMALLEY®	SPIROLOX® SERIES	MILITARY MIL-DTL-27426	AEROSPACE AS3219	METRIC AEROSPACE MA 4035	EUROPEAN SPECIFICATION DIN	WALDES TRUARC	EATON	INDUSTRIAL RETAINING RING	OTHER RINGS	ANDERTON
VH	UR	---	---	---	Groove Interchange Only Use a Smalley Retaining Ring to fit into the same groove of these stamped Retaining Rings (circlips).					
VS	US	---	---	---						
WH	RR	/3	AS4299 AS3217	---						
WS	RS	/1	AS4299 AS3218	---						
WHT	RRT	---	---	---	---	---	NAN	---	UHB	---
WST	RST	---	---	---	---	---	XAN	---	USC	---
WHM	RRN	/4	AS4299 AS3215	---	---	N5000 5008	IN	3000 4000	HO HOI UHO	N1300
WSM	RSN	/2	AS4299 AS3216	---	---	5100 5108	EN	3100 4100	SH SHI USH	N1400
DNH	---	---	---	---	DIN 472	---	---	---	DHO	D1300
DNS	---	---	---	---	DIN 471	---	---	---	DSH	D1400
EH	---	---	---	MA 4017	---	---	---	---	---	---
ES	---	---	---	MA 4016	---	---	---	---	---	---
FH	---	---	---	---	DIN 472	---	---	---	DHO	D1300
FS	---	---	---	---	DIN 471	---	---	---	DSH	D1400
XAH	---	---	---	---	---	---	NAN	---	UHB	---
XAS	---	---	---	---	---	---	XAN	---	USC	---
XDH	---	---	---	---	---	---	ND	---	HN	---
XDS	---	---	---	---	---	---	XD	---	SNL	---
XNH	---	---	---	---	---	---	IN	---	UHO	---
XNS	---	---	---	---	---	---	EN	---	USH	---



A. Rubber Boot

B. Pneumatic Fitting



C. Conduit Connector

D. Gear Bracket



E. Ratchet Wrench



F. Cylinder Housing

A. Rubber Boot

A 2-Turn Spirolox Retaining Ring clamps the rubber boot onto the groove making for a nearly perfect seal when the boot is filled with grease. The ring has been deburred so it will not tear into the rubber.

B. Pneumatic Fitting

An economical (without removal notches or offset) 2-Turn Spirolox Retaining Ring creates an ID/OD lock, permitting the 360° rotation of the nut. This permanent assembly is commonly used to hold two components together.

C. Conduit Connector

In this unique application, a Dished Retaining Ring was designed with sharp edges, to bite into the conduit it holds in place. The clamping force of the ring to the conduit (not shown) is achieved by screwing the nut. This decreases the ring's diameter as it advances in a tapered bore.

D. Gear Bracket

The worm gear shaft is held in place and pre-loaded using a 2-Turn Smalley WaveRing. The WaveRing fits an internal groove and the waveform in the ring allows the gear/shaft to float axially as the gear rotates.

E. Ratchet Wrench

This Single-Turn (it is actually 1½ turns) External Retaining Ring retains the internal mechanical components of the ratchet wrench. The additional ½ turn provides that little extra strength needed to prevent the ring from dislodging when the wrench is dropped.

F. Cylinder Housing

The Hoopster Retaining Ring in this application allows for a shallow groove in the cylinder housing without compromising the ability to have high forces applied to the Hoopster. Because the cylinder is thin, a normal retaining ring groove could not be used.

Ring Applications



G. Bike Lock



I. Gear Assembly



K. Pneumatic Clutch

H. Pressure Gauge

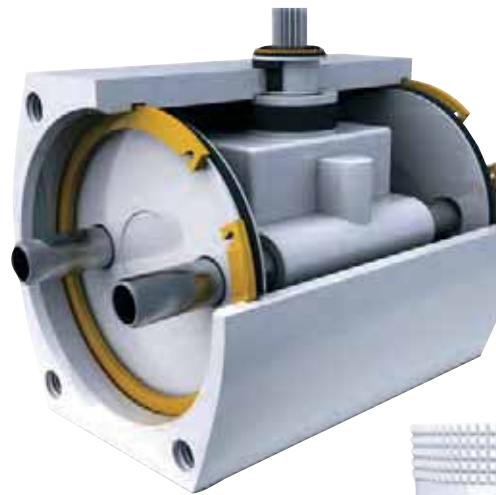
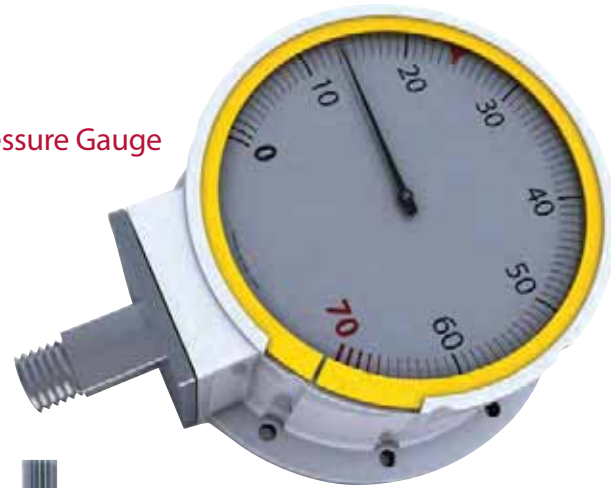

J. Actuator Valve



L. Hose Fitting

G. Bike Lock

Tamper-proof ring holds the lock assembly within its housing. The ring is considered tamper-proof because of reversed removal notches. Also, having a heavy cross-section makes the ring nearly impossible to remove.

H. Pressure Gauge

A retaining ring designed in a shallow groove exerts very light pressure on the glass lens in this pressure gauge. This single-turn retaining ring design provides the optimum load without breaking the glass.

I. Gear Assembly

External 2-Turn retaining ring prevents the pinion shafts from spinning when the gears are rotating. The Spirolox ring snaps securely on the groove and the ring's radial wall is designed to extend radially outward, clearing the four flat pinion shaft pins by 0,50 mm.

J. Actuator Valve

High thrust capacity was needed and a constant section ring was selected to absorb the occasional shock loading of the pistons.

K. Pneumatic Clutch

The internal components of this clutch are held in the housing using a heavy-duty constant section ring. Field servicing was often necessary and the snap ring was the ideal solution to the design requirement.

L. Hose Fitting

To keep the cap on the fitting, a single-turn retaining ring is located in a shallow internal groove. The wall thickness of the cap is small, so the ring was designed with square corners to operate in a very shallow groove.

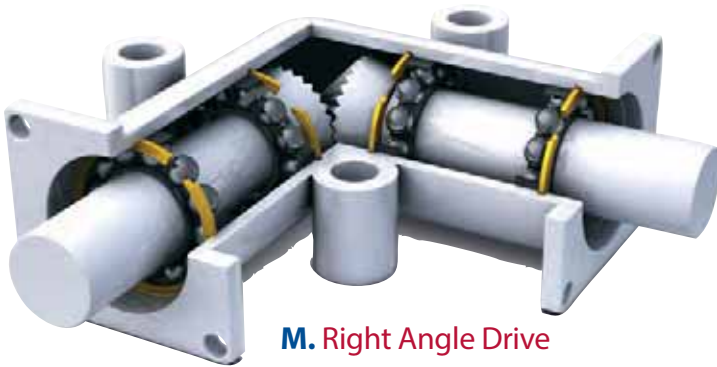

M. Right Angle Drive

N. Air Vent



O. Pulley



P. Belt Pulley



Q. ID/OD Lock



R. Hip Replacement

M. Right Angle Drive

Constant section rings secure the bearing assembly by providing removable shoulders in the bore. This simplifies the design of the gear box and replaces costly flanged end plates.

N. Air Vent

Single-turn, light-duty retaining ring fits tightly in the internal groove of a plastic air vent. Ring ends are dimensioned close together, providing nearly complete 360° ring support.

O. Pulley

2-Turn retaining rings provide 360° side walls as sides of the timing belt pulley. Design eliminates costly pressed-on stamped side walls. For belt replacement one ring can be easily removed.

P. Belt Pulley

Three hold down screws and a 2-Turn Spirolox Ring form a bi-directional shoulder. The shaft is inserted through the pulley and the retaining ring rests on the pulley face securing the shaft in one direction. Movement is prevented in the other direction with the three screws clamping down on the ring.

Q. ID/OD Lock

Single-turn retaining ring operates in an internal and external groove at the same time, commonly referred to as an ID/OD Lock. In this application, the ring fits tight on the body (shaft) groove and extends radially into the nut (housing). This allows the nut to spin freely but not come off the body.

R. Hip Replacement

A titanium Spirolox Retaining Ring is used in this hip replacement application to secure the shell and the liner together to form the socket of the new hip. Smalley's manufacturing process allows for the economical production of special alloy products.

Assembly Methods

Manual Installation

Manual installation on an individual or low production basis is accomplished as follows:

- Separate the ring coils and insert one end of the ring into the groove.
- Wind the ring by pressing down around the circumference until the entire ring is inserted into the groove.

Housing:



Shaft:



Semi-Automated and Automated Installation

For higher speed and automated assembly operations, simple tooling or assembly fixtures can be designed. External installation on a shaft can be accomplished with a plunger and tapered plug. The plug, angled at approximately 6 degrees, is centered over the shaft end. A loose fitting plunger pushes the ring into position over the tapered plug. An arbor press or air cylinder is commonly used to automate this assembly operation.

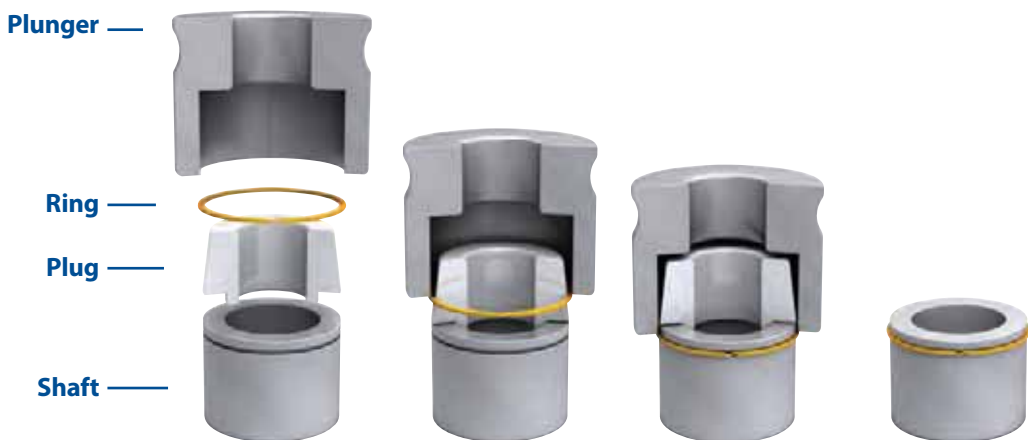

Internal retaining ring installation is accomplished in a similar manner. A tapered bore, which acts as a ring contracting guide, and a plunger pushes the retaining ring into position. Tooling for ring installation should have hardened working surfaces to minimize wear.



Using Screwdriver



Using Dental Pick



Removal

Smalley Retaining Rings are supplied standard with removal notches to enable easy extraction from a groove. The notch is provided to form a small gap between the ring end and the shaft or housing, permitting a blunt object to be inserted at the end of the ring to pry the free end out radially and up.

- Insert a screwdriver or dental pick behind the removal notch.
- Use the tool to pry out the first end of the ring.
- Manually spiral the ring around until it is free from the groove.

Smalley Tooling

Smalley's Spirolox Retaining Ring Removal Tool, part number RT-107, fits between the layers of a multiple turn retaining ring in order to access the removal notch. The end of the tool bit is slotted for the tip of the notch end to pass through. Once inserted, the ring end may be pulled out radially and up.

Visit www.smalley.com/retaining_rings/installation_and_removal.asp for more information about installation and removal.

Stock Items available in carbon steel and 302 and 316 stainless steel.

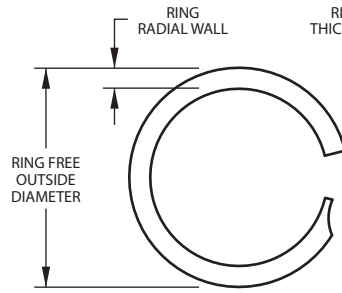
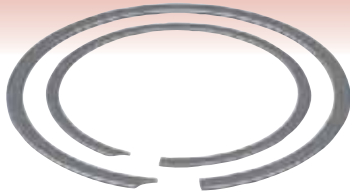

*No removal notch

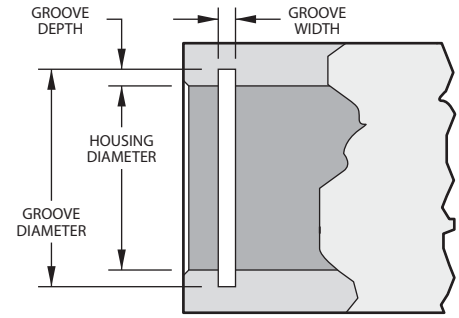

Product Dimensions All dimensions in millimeters unless otherwise specified.

Smalley Part Number ^{1,4}	Housing Diameter	Ring			Groove		Thrust Capacity	
		Outside Diameter	Radial Wall	Thickness	Diameter	Width	Groove Yield (N) ²	Ring Shear (N) ³
VHM-6*	6,00	6,35	0,51	0,30	6,30	0,38	439	1988
VHM-7*	7,00	7,38	0,51	0,30	7,32	0,38	546	2320
VHM-8*	8,00	8,44	0,64	0,38	8,36	0,46	702	3183
VHM-9*	9,00	9,54	0,76	0,38	9,46	0,46	1003	3580
VHM-10*	10,00	10,58	0,76	0,38	10,50	0,46	1238	3978
VHM-11	11,00	11,68	0,89	0,38	11,60	0,46	1634	4388
VHM-12	12,00	12,74	0,89	0,38	12,66	0,46	1930	4774
VHM-13	13,00	13,80	1,14	0,46	13,72	0,56	2281	6261
VHM-14	14,00	14,80	1,14	0,46	14,72	0,56	2456	6742
VHM-15	15,00	15,80	1,14	0,46	15,72	0,56	2632	7224
VHM-16	16,00	16,80	1,14	0,46	16,72	0,56	2807	7705
VHM-17	17,00	17,82	1,14	0,46	17,72	0,56	2983	8187
VHM-18	18,00	18,82	1,14	0,46	18,72	0,56	3158	8669
VHM-19	19,00	19,86	1,14	0,46	19,76	0,56	3519	9150
VHM-20	20,00	21,26	1,65	0,53	21,06	0,66	5166	11097
VHM-21	21,00	22,27	1,65	0,53	22,06	0,66	5424	11652
VHM-22	22,00	23,28	1,65	0,53	23,06	0,66	5683	12207
VHM-24	24,00	25,29	1,65	0,53	25,06	0,66	6199	13317
VHM-25	25,00	26,30	1,65	0,53	26,06	0,66	6458	13872
VHM-26	26,00	27,31	1,65	0,53	27,06	0,66	6716	14427
VHM-28	28,00	29,40	2,24	0,64	29,12	0,79	7642	16303
VHM-29	29,00	30,41	2,24	0,64	30,12	0,79	7915	16885
VHM-30	30,00	31,42	2,24	0,64	31,12	0,79	8188	17467
VHM-31	31,00	32,43	2,24	0,64	32,12	0,79	8461	18049
VHM-32	32,00	33,44	2,24	0,64	33,12	0,79	8734	18632
VHM-34	34,00	35,45	2,24	0,64	35,12	0,79	9279	19796
VHM-35	35,00	36,47	2,24	0,64	36,12	0,79	9552	20378
VHM-36	36,00	37,48	2,24	0,64	37,12	0,79	9825	20960
VHM-37	37,00	38,49	2,24	0,64	38,12	0,79	10098	21543
VHM-38	38,00	39,50	2,24	0,64	39,12	0,79	10371	22125
VHM-40	40,00	41,94	3,00	0,79	41,48	0,99	14426	28748
VHM-42	42,00	43,96	3,00	0,79	43,48	0,99	15147	30185
VHM-45	45,00	46,99	3,00	0,79	46,48	0,99	16229	32341
VHM-47	47,00	49,00	3,00	0,79	48,48	0,99	16950	33779
VHM-48	48,00	50,01	3,00	0,79	49,48	0,99	17311	34497
VHM-50	50,00	52,04	3,00	0,79	51,48	0,99	18032	35935
VHM-52	52,00	54,55	4,01	0,79	53,94	0,99	24583	37372
VHM-55	55,00	57,57	4,01	0,79	56,94	0,99	26001	39528
VHM-56	56,00	58,58	4,01	0,79	57,94	0,99	26473	40247
VHM-58	58,00	60,60	4,01	0,79	59,94	0,99	27419	41684
VHM-60	60,00	62,64	4,01	0,79	61,94	0,99	28364	43122
VHM-62	62,00	64,67	4,01	0,79	63,94	0,99	29310	44559
VHM-63	63,00	65,69	4,01	0,79	64,94	0,99	29783	45278
VHM-65	65,00	67,70	4,01	0,79	66,94	0,99	30728	46715
VHM-68	68,00	70,72	4,01	0,79	69,94	0,99	32146	48871
VHM-70	70,00	72,74	4,01	0,79	71,94	0,99	33092	50309
VHM-72	72,00	74,77	4,01	0,79	73,94	0,99	34037	51746
VHM-75	75,00	77,80	4,01	0,79	76,94	0,99	35456	53902

¹ Add suffix "-S02" for 302 stainless steel. Add suffix "-S16" for 316 stainless steel.

² Based on a groove material yield strength of 310 N/mm² and a safety factor of 2.

³ Based on a safety factor of 3.

⁴ See pages 134 – 135 for How to Order.

Smalley Part Number ^{1,4}	Housing Diameter	Ring			Groove		Thrust Capacity	
		Outside Diameter	Radial Wall	Thickness	Diameter	Width	Groove Yield (N) ²	Ring Shear (N) ³
VHM-78	78,00	81,20	4,78	0,99	80,34	1,12	44477	70250
VHM-80	80,00	83,23	4,78	0,99	82,34	1,12	45617	72052
VHM-82	82,00	85,25	4,78	0,99	84,34	1,12	46757	73853
VHM-85	85,00	88,29	4,78	0,99	87,34	1,12	48468	76555
VHM-88	88,00	91,32	4,78	0,99	90,34	1,12	50179	79257
VHM-90	90,00	93,36	4,78	0,99	92,34	1,12	51319	81058
VHM-92	92,00	95,37	4,78	0,99	94,34	1,12	52460	82859
VHM-95	95,00	98,39	4,78	0,99	97,34	1,12	54170	85561
VHM-98	98,00	101,41	4,78	0,99	100,34	1,12	55881	88263
VHM-100	100,00	103,43	4,78	0,99	102,34	1,12	57021	90064
VHM-102	102,00	105,44	4,78	0,99	104,34	1,12	58162	91866
VHM-105	105,00	108,92	5,72	1,17	107,80	1,32	71642	106440
VHM-110	110,00	113,98	5,72	1,17	112,80	1,32	75054	111508
VHM-112	112,00	116,01	5,72	1,17	114,80	1,32	76418	113536
VHM-115	115,00	119,12	5,72	1,17	117,88	1,32	80707	116577
VHM-120	120,00	124,30	5,72	1,17	123,00	1,32	87725	121645
VHM-125	125,00	129,47	5,72	1,17	128,12	1,32	95036	126714
VHM-130	130,00	134,66	5,72	1,17	133,26	1,32	103272	131783
VHM-135	135,00	139,83	5,72	1,55	138,38	1,70	111192	181299
VHM-140	140,00	145,00	5,72	1,55	143,50	1,70	119404	188013
VHM-145	145,00	150,17	5,72	1,55	148,62	1,70	127974	194907
VHM-150	150,00	155,30	6,73	1,55	153,76	1,70	137436	201443
VHM-155	155,00	160,46	6,73	1,55	158,88	1,70	146361	208158
VHM-160	160,00	165,64	6,73	1,55	164,00	1,70	155956	214872
VHM-165	165,00	170,82	6,73	1,55	169,13	1,70	165855	221587
VHM-170	170,00	175,99	6,73	1,55	174,25	1,70	176059	228302
VHM-175	175,00	181,17	6,73	1,55	179,38	1,70	186568	235017
VHM-180	180,00	186,35	6,73	1,55	184,50	1,70	197381	241731
VHM-185	185,00	191,52	6,73	1,55	189,63	1,70	208499	248446
VHM-190	190,00	196,70	6,73	1,55	194,75	1,70	219922	255161
VHM-195	195,00	201,87	7,62	1,55	199,88	1,70	231649	261876
VHM-200	200,00	207,05	7,62	1,55	205,00	1,70	243681	268590
VHM-210	210,00	217,40	7,62	1,55	215,25	1,70	268658	282020
VHM-220	220,00	227,76	8,76	1,93	225,50	2,08	294854	367882
VHM-230	230,00	238,11	8,76	1,93	235,75	2,08	322268	384604
VHM-240	240,00	248,46	8,76	1,93	246,00	2,08	350900	401326
VHM-250	250,00	258,81	8,76	1,93	256,25	2,08	380751	418048
VHM-260	260,00	269,17	9,65	1,93	266,50	2,08	411821	434770
VHM-270	270,00	279,52	9,65	1,93	276,75	2,08	444108	451492
VHM-280	280,00	289,87	9,65	1,93	287,00	2,08	477614	468214
VHM-290	290,00	300,22	9,65	1,93	297,25	2,08	512339	484936
VHM-300	300,00	310,58	9,65	1,93	307,50	2,08	548282	501658

¹ Add suffix "-S02" for 302 stainless steel. Add suffix "-S16" for 316 stainless steel.
² Based on a groove material yield strength of 310 N/mm² and a safety factor of 2.
³ Based on a safety factor of 3.
⁴ See pages 134 –135 for How to Order.

Stock Items available in carbon steel and 302 and 316 stainless steel.



MA 4017⁵

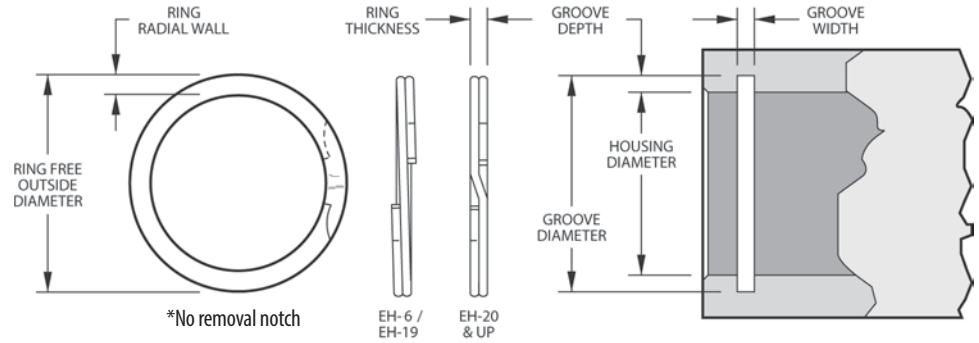

Product Dimensions All dimensions in millimeters unless otherwise specified.

Smalley Part Number ^{1,4}	Housing Diameter	Ring			Groove		Thrust Capacity	
		Outside Diameter	Radial Wall	Thickness	Diameter	Width	Groove Yield (N) ²	Ring Shear (N) ³
EH-6 *	6,00	6,35	0,33 - 0,53	0,38	6,30	0,51	440	1880
EH-7 *	7,00	7,37	0,33 - 0,53	0,38	7,32	0,51	550	2190
EH-8 *	8,00	8,51	0,51 - 0,71	0,38	8,43	0,51	840	2500
EH-9 *	9,00	9,60	0,64 - 0,84	0,64	9,50	0,74	1100	4740
EH-10 *	10,00	10,62	0,64 - 0,84	0,64	10,52	0,74	1270	5270
EH-11	11,00	11,79	0,76 - 0,96	0,64	11,71	0,74	1900	5790
EH-12	12,00	12,89	1,02 - 1,22	0,60	12,70	0,70	2050	7950
EH-13	13,00	13,95	1,02 - 1,22	0,89	13,75	1,00	2410	12110
EH-14	14,00	15,07	1,27 - 1,47	0,89	14,85	1,00	2930	13040
EH-15	15,00	16,14	1,27 - 1,47	0,89	15,90	1,00	3290	13970
EH-16	16,00	17,15	1,27 - 1,47	0,89	16,95	1,00	3740	14900
EH-17	17,00	18,32	1,52 - 1,73	0,89	18,05	1,00	4390	15830
EH-18	18,00	19,39	1,52 - 1,73	0,89	19,10	1,00	4820	16760
EH-19	19,00	20,48	1,52 - 1,73	0,89	20,17	1,00	5460	17690
EH-20	20,00	21,51	1,78 - 1,98	0,89	21,22	1,00	5940	18620
EH-21	21,00	22,56	1,78 - 1,98	0,89	22,27	1,00	6550	19550
EH-22	22,00	23,65	1,78 - 1,98	1,07	23,37	1,20	7390	24630
EH-23	23,00	24,69	2,03 - 2,24	1,07	24,42	1,20	7950	25750
EH-24	24,00	25,73	2,03 - 2,24	1,07	25,47	1,20	8650	26870
EH-25	25,00	27,03	2,03 - 2,24	1,07	26,67	1,20	10230	27990
EH-26	26,00	28,07	2,03 - 2,24	1,07	27,77	1,20	11270	29110
EH-27	27,00	29,11	2,49 - 2,69	1,27	28,87	1,40	12360	31170
EH-28	28,00	30,10	2,49 - 2,69	1,27	29,87	1,40	12820	32330
EH-29	29,00	31,21	2,49 - 2,69	1,27	30,95	1,40	13840	33480
EH-30	30,00	32,28	2,49 - 2,69	1,27	32,00	1,40	14610	34640
EH-31	31,00	33,32	2,49 - 2,69	1,27	33,05	1,40	15550	35790
EH-32	32,00	34,23	2,49 - 2,69	1,27	34,00	1,40	15880	36950
EH-34	34,00	36,46	2,87 - 3,07	1,27	36,20	1,40	18210	39260
EH-35	35,00	37,55	2,87 - 3,07	1,27	37,30	1,40	19600	40410
EH-36	36,00	38,68	2,87 - 3,07	1,27	38,40	1,40	21040	41560
EH-37	37,00	39,60	2,87 - 3,07	1,27	39,40	1,40	21620	42720
EH-38	38,00	40,77	2,87 - 3,07	1,27	40,50	1,40	23130	43870
EH-40	40,00	42,91	3,12 - 3,33	1,57	42,50	1,75	24350	57090
EH-42	42,00	45,01	3,12 - 3,33	1,57	44,60	1,75	26590	59950
EH-45	45,00	48,13	3,12 - 3,33	1,57	47,70	1,75	29590	64230
EH-46	46,00	49,28	3,12 - 3,33	1,57	48,80	1,75	31370	65660
EH-47	47,00	50,32	3,89 - 4,09	1,57	49,90	1,75	33190	67080
EH-48	48,00	51,46	3,89 - 4,09	1,57	51,00	1,75	35070	68510
EH-50	50,00	53,66	3,89 - 4,09	1,57	53,20	1,75	38960	71370
EH-52	52,00	54,30	3,12 - 3,33	1,25	53,79	1,42	22790	59090
EH-53	53,00	55,32	3,12 - 3,33	1,25	54,79	1,42	23230	60230
EH-55	55,00	57,38	3,38 - 3,58	1,25	56,85	1,42	24910	62500
EH-56	56,00	58,40	3,38 - 3,58	1,25	57,85	1,42	25360	63640
EH-58	58,00	60,43	3,38 - 3,58	1,25	59,85	1,42	26270	65910
EH-59	59,00	61,54	3,38 - 3,58	1,25	60,93	1,42	27870	67050
EH-60	60,00	62,57	3,38 - 3,58	1,25	61,99	1,42	29220	68180

¹ Add suffix "-S02" for 302 stainless steel, "-S16" for 316 stainless steel.

² Based on a groove material yield strength of 310 N/mm² and a safety factor of 2.

³ Based on a safety factor of 3.

⁴ See pages 134 - 135 for How to Order.

⁵ Contact Smalley for details/information on how to order parts to be in compliance with this specification.

Smalley Part Number ^{1,4}	Housing Diameter	Ring			Groove		Thrust Capacity	
		Outside Diameter	Radial Wall	Thickness	Diameter	Width	Groove Yield (N) ²	Ring Shear (N) ³
EH-61	61,00	63,65	3,63 - 3,84	1,25	63,09	1,42	31190	69320
EH-62	62,00	64,70	3,63 - 3,84	1,25	64,09	1,42	31700	70460
EH-63	63,00	65,70	3,63 - 3,84	1,25	65,09	1,42	32220	71590
EH-64	64,00	66,77	3,63 - 3,84	1,25	66,19	1,42	34290	72730
EH-65	65,00	67,82	3,63 - 3,84	1,25	67,19	1,42	34820	73870
EH-66	66,00	68,80	3,63 - 3,84	1,25	68,19	1,42	35360	75000
EH-67	67,00	69,90	3,63 - 3,84	1,25	69,25	1,42	36870	76140
EH-68	68,00	70,94	3,89 - 4,09	1,25	70,29	1,42	38090	77270
EH-69	69,00	71,94	3,89 - 4,09	1,25	71,29	1,42	38650	78410
EH-70	70,00	72,94	3,89 - 4,09	1,25	72,29	1,42	39210	79550
EH-71	71,00	73,99	3,89 - 4,09	1,25	73,29	1,42	39770	80680
EH-72	72,00	75,04	4,11 - 4,39	1,25	74,39	1,42	40910	81510
EH-75	75,00	78,07	4,11 - 4,39	1,25	77,39	1,42	43830	85230
EH-78	78,00	81,21	4,11 - 4,39	1,55	80,45	1,73	46730	109910
EH-80	80,00	83,22	4,37 - 4,62	1,55	82,49	1,73	48700	112730
EH-82	82,00	85,28	4,37 - 4,62	1,55	84,55	1,73	51120	115550
EH-85	85,00	88,38	4,62 - 4,88	1,55	87,65	1,73	55060	119780
EH-88	88,00	91,45	4,62 - 4,88	1,55	90,69	1,73	57860	124000
EH-90	90,00	93,58	4,88 - 5,13	1,55	92,79	1,73	61370	126820
EH-92	92,00	95,66	4,88 - 5,13	1,55	94,85	1,73	64070	129640
EH-95	95,00	98,69	4,88 - 5,13	1,55	97,85	1,73	66160	133870
EH-98	98,00	101,83	5,13 - 5,38	1,55	100,99	1,73	71590	138090
EH-100	100,00	103,83	5,13 - 5,38	1,55	102,99	1,73	73050	140910
EH-102	102,00	106,00	5,38 - 5,64	1,55	105,15	1,73	78490	143730
EH-105	105,00	109,00	5,38 - 5,64	1,55	108,15	1,73	80800	147960
EH-108	108,00	112,22	5,64 - 5,89	1,55	111,31	1,73	87310	152190
EH-110	110,00	114,25	5,64 - 5,89	1,55	113,31	1,73	62140	155000
EH-112	112,00	116,44	5,89 - 6,15	1,55	115,45	1,73	94370	157820
EH-115	115,00	119,44	5,89 - 6,15	1,55	118,45	1,73	96890	162050
EH-120	120,00	124,54	6,20 - 6,45	1,83	123,55	2,00	104030	199640
EH-125	125,00	129,59	6,20 - 6,45	1,83	128,55	2,00	108360	207960
EH-130	130,00	134,71	6,20 - 6,45	1,83	133,65	2,00	115860	216280
EH-135	135,00	139,74	6,20 - 6,45	1,83	138,62	2,00	119000	224600
EH-140	140,00	144,87	6,20 - 6,45	1,83	143,72	2,00	126820	232920
EH-145	145,00	150,04	6,20 - 6,45	1,83	148,82	2,00	134880	241230
EH-150	150,00	155,07	6,20 - 6,45	1,83	153,82	2,00	139530	249550
EH-155	155,00	160,72	7,72 - 8,03	2,18	159,40	2,40	166080	307190
EH-160	160,00	165,74	7,72 - 8,03	2,18	164,40	2,40	171433	317100
EH-165	165,00	170,77	7,72 - 8,03	2,18	169,40	2,40	176790	327010
EH-170	170,00	176,05	7,72 - 8,03	2,18	174,60	2,40	190430	336920
EH-175	175,00	181,05	7,72 - 8,03	2,18	179,60	2,40	196030	346830
EH-180	180,00	186,38	7,72 - 8,03	2,18	184,88	2,40	213900	356740
EH-185	185,00	191,10	7,72 - 8,03	2,18	189,88	2,40	219840	366650
EH-190	190,00	196,45	7,72 - 8,03	2,18	194,88	2,40	225790	376560
EH-195	195,00	201,74	7,72 - 8,03	2,18	200,14	2,40	244070	386460
EH-200	200,00	206,76	7,72 - 8,03	2,18	205,14	2,40	250330	396370
EH-210	210,00	217,10	9,32 - 9,63	2,18	215,40	2,40	276140	416490
EH-220	220,00	227,40	9,32 - 9,63	2,18	225,64	2,40	257150	436010
EH-230	230,00	237,73	9,32 - 9,63	2,18	235,90	2,40	330450	455830
EH-240	240,00	247,80	9,32 - 9,63	2,18	245,90	2,40	344810	475650
EH-250	250,00	258,10	9,32 - 9,63	2,18	256,16	2,40	375010	495470
EH-260	260,00	268,43	9,32 - 9,63	2,18	266,40	2,40	405210	515290
EH-270	270,00	278,50	9,32 - 9,63	2,18	276,40	2,40	420790	535100
EH-280	280,00	288,82	9,32 - 9,63	2,18	286,66	2,40	454100	554920

¹ Add suffix "-S02" for 302 stainless steel, "-S16" for 316 stainless steel.
² Based on a groove material yield strength of 310 N/mm² and a safety factor of 2.
³ Based on a safety factor of 3.
⁴ See pages 134 - 135 for How to Order.
⁵ Contact Smalley for details/information on how to order parts to be in compliance with this specification.

Stock Items available in carbon steel and 302 and 316 stainless steel.



Groove Compatible with DIN 472

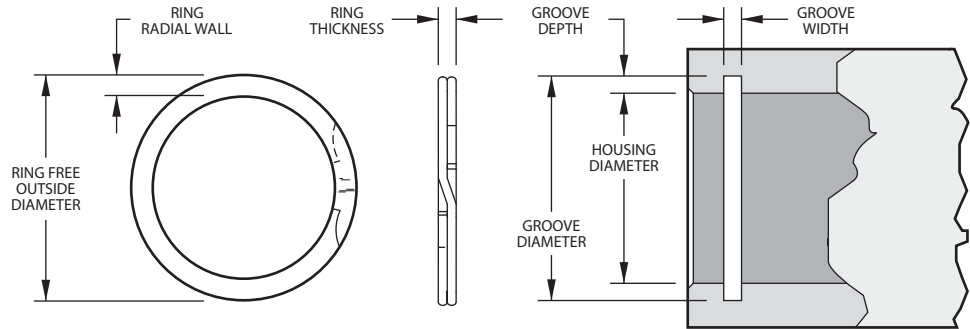

Product Dimensions All dimensions in millimeters unless otherwise specified.

Smalley Part Number ^{1,4}	Housing Diameter	Ring			Groove		Thrust Capacity	
		Outside Diameter	Radial Wall	Thickness	Diameter	Width	Groove Yield (N) ²	Ring Shear (N) ³
DNH-13	13,00	13,72	1,40	0,99	13,60	1,10	1901	13474
DNH-14	14,00	14,75	1,40	0,99	14,60	1,10	2047	14510
DNH-15	15,00	15,85	1,40	0,99	15,70	1,10	2559	15547
DNH-16	16,00	16,97	1,65	0,99	16,80	1,10	3119	16583
DNH-17	17,00	17,98	1,65	0,99	17,80	1,10	3314	17620
DNH-18	18,00	19,18	1,91	0,99	19,00	1,10	4386	18656
DNH-19	19,00	20,19	1,91	0,99	20,00	1,10	4630	19693
DNH-20	20,00	21,21	1,91	0,99	21,00	1,10	4874	20729
DNH-21	21,00	22,23	1,91	0,99	22,00	1,10	5117	21766
DNH-22	22,00	23,23	1,91	0,99	23,00	1,10	5361	22802
DNH-23	23,00	24,33	2,18	1,14	24,10	1,30	6165	23853
DNH-24	24,00	25,45	2,18	1,14	25,20	1,30	7018	24891
DNH-25	25,00	26,45	2,18	1,14	26,20	1,30	7310	25928
DNH-26	26,00	27,48	2,18	1,14	27,20	1,30	7603	26965
DNH-27	27,00	28,68	2,41	1,14	28,40	1,30	9211	28002
DNH-28	28,00	29,69	2,41	1,14	29,40	1,30	9552	29039
DNH-29	29,00	30,71	2,41	1,14	30,40	1,30	9893	30076
DNH-30	30,00	31,71	2,41	1,14	31,40	1,30	10235	31113
DNH-31	31,00	33,02	2,41	1,14	32,70	1,30	12842	32150
DNH-32	32,00	34,04	2,41	1,14	33,70	1,30	13256	33187
DNH-33	33,00	35,05	2,41	1,14	34,70	1,30	13670	34224
DNH-34	34,00	36,07	3,25	1,44	35,70	1,60	14085	44541
DNH-35	35,00	37,38	3,25	1,44	37,00	1,60	17058	45851
DNH-36	36,00	38,39	3,25	1,44	38,00	1,60	17545	47161
DNH-37	37,00	39,40	3,25	1,44	39,00	1,60	18032	48471
DNH-38	38,00	40,41	3,25	1,44	40,00	1,60	18520	49781
DNH-40	40,00	42,93	4,01	1,69	42,50	1,85	24368	61498
DNH-41	41,00	43,94	4,01	1,69	43,50	1,85	24977	63036
DNH-42	42,00	44,96	4,01	1,69	44,50	1,85	25586	64573
DNH-45	45,00	47,98	4,01	1,69	47,50	1,85	27414	69186
DNH-47	47,00	49,99	4,01	1,69	49,50	1,85	28633	72261
DNH-48	48,00	51,00	4,01	1,69	50,50	1,85	29242	73798
DNH-50	50,00	53,54	5,08	1,93	53,00	2,15	36552	87790
DNH-51	51,00	54,54	5,08	1,93	54,00	2,15	37283	89546
DNH-52	52,00	55,55	5,08	1,93	55,00	2,15	38014	91302
DNH-55	55,00	58,57	5,08	1,93	58,00	2,15	40207	96569
DNH-56	56,00	59,59	5,08	1,93	59,00	2,15	40938	98325
DNH-57	57,00	60,60	5,08	1,93	60,00	2,15	41669	100081
DNH-58	58,00	61,62	5,08	1,93	61,00	2,15	42400	101836
DNH-60	60,00	63,63	5,08	1,93	63,00	2,15	43863	105348
DNH-62	62,00	65,66	5,08	1,93	65,00	2,15	45325	108860
DNH-63	63,00	66,67	5,08	1,93	66,00	2,15	46056	110615
DNH-64	64,00	67,67	5,08	1,93	67,00	2,15	46787	112371

¹ Add suffix "-S02" for 302 stainless steel, "-S16" for 316 stainless steel.

² Based on a groove material yield strength of 310 N/mm² and a safety factor of 2.

³ Based on a safety factor of 3.

⁴ See pages 134 – 135 for How to Order.

Smalley Part Number ^{1,4}	Housing Diameter	Ring			Groove		Thrust Capacity	
		Outside Diameter	Radial Wall	Thickness	Diameter	Width	Groove Yield (N) ²	Ring Shear (N) ³
DNH-65	65,00	68,67	5,08	2,41	68,00	2,65	47518	135725
DNH-67	67,00	70,67	5,08	2,41	70,00	2,65	48980	139901
DNH-68	68,00	71,67	5,08	2,41	71,00	2,65	49711	141989
DNH-70	70,00	73,67	5,08	2,41	73,00	2,65	51173	146165
DNH-72	72,00	75,67	5,08	2,41	75,00	2,65	52635	150341
DNH-75	75,00	78,68	5,08	2,41	78,00	2,65	54828	156605
DNH-76	76,00	79,68	5,08	2,41	79,00	2,65	55559	158694
DNH-78	78,00	81,69	5,08	2,41	81,00	2,65	57021	162870
DNH-80	80,00	84,19	6,05	2,41	83,50	2,65	68231	167046
DNH-82	82,00	86,20	6,05	2,41	85,50	2,65	69936	171222
DNH-85	85,00	89,20	6,05	2,91	88,50	3,15	72495	214309
DNH-88	88,00	92,21	6,05	2,91	91,50	3,15	75054	221873
DNH-90	90,00	94,21	6,05	2,91	93,50	3,15	76759	226915
DNH-92	92,00	96,22	6,05	2,91	95,50	3,15	78465	231958
DNH-95	95,00	99,24	6,05	2,91	98,50	3,15	81024	239522
DNH-98	98,00	102,26	6,05	2,91	101,50	3,15	83583	247086
DNH-100	100,00	104,29	6,05	2,91	103,50	3,15	85288	252128
DNH-102	102,00	106,79	6,73	3,89	106,00	4,15	99422	343778
DNH-105	105,00	109,79	6,73	3,89	109,00	4,15	102346	353889
DNH-108	108,00	112,80	6,73	3,89	112,00	4,15	105270	364000
DNH-110	110,00	114,83	6,73	3,89	114,00	4,15	107220	370741
DNH-112	112,00	116,84	6,73	3,89	116,00	4,15	109169	377482
DNH-115	115,00	119,86	6,73	3,89	119,00	4,15	112093	387593
DNH-120	120,00	124,92	6,73	3,89	124,00	4,15	116967	404445
DNH-125	125,00	129,97	6,73	3,89	129,00	4,15	121840	421297
DNH-127	127,00	131,97	6,73	3,89	131,00	4,15	123790	428038
DNH-130	130,00	135,00	6,73	3,89	134,00	4,15	126714	438149
DNH-135	135,00	140,03	6,73	3,89	139,00	4,15	131588	455001
DNH-140	140,00	145,11	6,73	3,89	144,00	4,15	136461	471852
DNH-145	145,00	150,11	6,73	3,89	149,00	4,15	141335	488704
DNH-150	150,00	156,13	7,92	3,89	155,00	4,15	182761	505556
DNH-155	155,00	161,19	7,92	3,89	160,00	4,15	188853	522408
DNH-160	160,00	166,22	7,92	3,89	165,00	4,15	194945	539260
DNH-165	165,00	171,27	7,92	3,89	170,00	4,15	201037	556112
DNH-170	170,00	176,33	7,92	3,89	175,00	4,15	207129	572964
DNH-175	175,00	181,36	7,92	3,89	180,00	4,15	213221	589815
DNH-180	180,00	186,39	7,92	3,89	185,00	4,15	219313	606667
DNH-185	185,00	191,44	7,92	3,89	190,00	4,15	225405	623519
DNH-190	190,00	196,47	7,92	3,89	195,00	4,15	231497	640371
DNH-195	195,00	201,52	7,92	3,89	200,00	4,15	237589	657223
DNH-200	200,00	206,58	7,92	3,89	205,00	4,15	243681	674075
DNH-210	210,00	217,58	9,53	4,86	216,00	5,15	307038	884268
DNH-220	220,00	227,66	9,53	4,86	226,00	5,15	321659	926376
DNH-230	230,00	237,72	9,53	4,86	236,00	5,15	336280	968484
DNH-240	240,00	247,80	9,53	4,86	246,00	5,15	350900	1010592
DNH-250	250,00	257,89	9,53	4,86	256,00	5,15	365521	1052700
DNH-260	260,00	269,93	11,18	4,86	268,00	5,15	506856	1094808
DNH-270	270,00	280,01	11,18	4,86	278,00	5,15	526351	1136916
DNH-280	280,00	290,09	11,18	4,86	288,00	5,15	545845	1179024
DNH-290	290,00	300,15	11,18	4,86	298,00	5,15	565340	1221132
DNH-300	300,00	310,24	11,18	4,86	308,00	5,15	584834	1263241
DNH-310	310,00	322,25	12,70	5,87	320,00	6,20	755411	1576625
DNH-320	320,00	332,33	12,70	5,87	330,00	6,20	779779	1627484
DNH-330	330,00	342,42	12,70	5,87	340,00	6,20	804147	1678342
DNH-340	340,00	352,50	12,70	5,87	350,00	6,20	828515	1729201
DNH-350	350,00	362,56	12,70	5,87	360,00	6,20	852883	1780060
DNH-360	360,00	372,64	12,70	5,87	370,00	6,20	877251	1830919
DNH-370	370,00	382,73	12,70	5,87	380,00	6,20	901619	1881778
DNH-380	380,00	392,79	12,70	5,87	390,00	6,20	925987	1932637
DNH-390	390,00	402,84	12,70	5,87	400,00	6,20	950355	1983496
DNH-400	400,00	412,93	12,70	5,87	410,00	6,20	974723	2034354

¹ Add suffix "-S02" for 302 stainless steel, "-S16" for 316 stainless steel.
² Based on a groove material yield strength of 310 N/mm² and a safety factor of 2.
³ Based on a safety factor of 3.
⁴ See pages 134 – 135 for How to Order.

Stock Items available in carbon steel and 302 stainless steel.

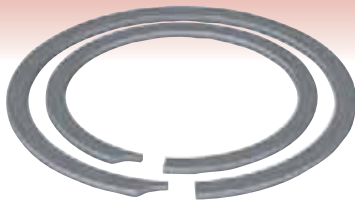

Groove Compatible with DIN 472

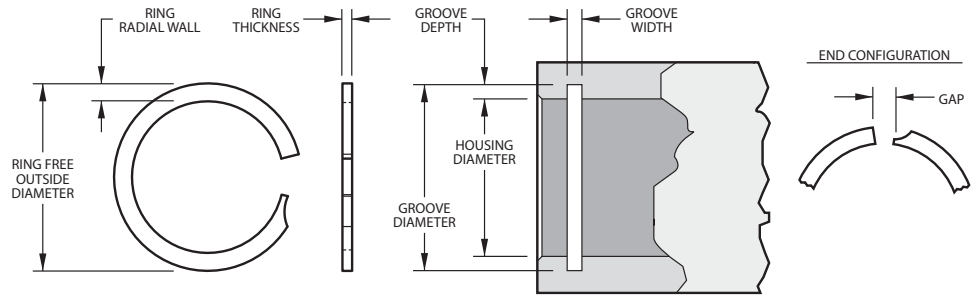

Product Dimensions All dimensions in millimeters unless otherwise specified.

Smalley Part Number ^{1,4}	Housing Diameter	Ring			Groove		Thrust Capacity	
		Outside Diameter	Radial Wall	Thickness	Diameter	Width	Groove Yield (N) ²	Ring Shear (N) ³
FH-013	13,00	13,73	1,40	0,94	13,60	1,10	1931	10591
FH-014	14,00	14,74	1,40	0,94	14,60	1,10	2077	11396
FH-015	15,00	15,85	1,40	0,94	15,70	1,10	2602	12224
FH-016	16,00	16,90	1,65	0,94	16,80	1,10	3172	13029
FH-017	17,00	17,97	1,65	0,94	17,80	1,10	3367	13838
FH-018	18,00	19,18	1,90	0,94	19,00	1,10	4457	14666
FH-019	19,00	20,25	1,90	0,94	20,00	1,10	4702	15471
FH-020	20,00	21,20	1,90	0,94	21,00	1,10	4951	16276
FH-021	21,00	22,21	1,90	0,94	22,00	1,10	5200	17103
FH-022	22,00	23,22	1,90	0,94	23,00	1,10	5445	17913
FH-023	23,00	24,23	1,90	0,94	24,00	1,10	5698	18736
FH-024	24,00	25,40	2,15	1,15	25,20	1,30	6539	23927
FH-025	25,00	26,45	2,15	1,15	26,20	1,30	6806	24914
FH-026	26,00	27,46	2,15	1,15	27,20	1,30	7082	25929
FH-027	27,00	28,47	2,38	1,15	28,20	1,30	7353	26916
FH-028	28,00	29,68	2,38	1,15	29,40	1,30	9702	27904
FH-029	29,00	30,69	2,38	1,15	30,40	1,30	10053	28918
FH-030	30,00	31,79	2,38	1,15	31,40	1,30	10395	29905
FH-031	31,00	33,01	2,38	1,15	32,70	1,30	12660	30893
FH-032	32,00	33,93	2,38	1,15	33,70	1,30	13073	31907
FH-033	33,00	35,03	2,38	1,15	34,70	1,30	13478	32895
FH-034	34,00	36,04	3,25	1,44	35,70	1,60	13892	40319
FH-035	35,00	37,35	3,25	1,44	37,00	1,60	16899	41493
FH-036	36,00	38,36	3,25	1,44	38,00	1,60	17375	42663
FH-037	37,00	39,37	3,25	1,44	39,00	1,60	17869	43868
FH-038	38,00	40,44	3,25	1,44	40,00	1,60	18344	45043
FH-040	40,00	42,86	4,01	1,69	42,50	1,85	24265	55621
FH-041	41,00	43,91	4,01	1,69	43,50	1,85	24866	56995
FH-042	42,00	44,92	4,01	1,69	44,50	1,85	25484	58410
FH-045	45,00	47,88	4,01	1,69	47,50	1,85	27303	62578
FH-047	47,00	49,97	4,01	1,69	49,50	1,85	28504	65331
FH-048	48,00	50,98	4,01	1,69	50,50	1,85	29118	66741
FH-050	50,00	53,50	5,08	1,93	53,00	2,15	36529	75282
FH-051	51,00	54,43	5,08	1,93	54,00	2,15	37249	76776
FH-052	52,00	55,52	5,08	1,93	55,00	2,15	37974	78266
FH-055	55,00	58,55	5,08	1,93	58,00	2,15	40163	82777
FH-056	56,00	59,56	5,08	1,93	59,00	2,15	40906	84307
FH-057	57,00	60,68	5,08	1,93	60,00	2,15	41631	85797
FH-058	58,00	61,58	5,08	1,93	61,00	2,15	42352	87287
FH-060	60,00	63,60	5,08	1,93	63,00	2,15	43819	90308
FH-062	62,00	65,58	5,08	1,93	65,00	2,15	45283	93328
FH-063	63,00	66,63	5,08	1,93	66,00	2,15	46008	94823
FH-064	64,00	67,64	5,08	2,41	67,00	2,65	46751	114742

¹ Add suffix "-S02" for 302 stainless steel.

² Based on a groove material yield strength of 310 N/mm² and a safety factor of 2.

³ Based on a safety factor of 3.

⁴ See pages 134 –135 for How to Order.

Smalley Part Number ^{1,4}	Housing Diameter	Ring			Groove		Thrust Capacity	
		Outside Diameter	Radial Wall	Thickness	Diameter	Width	Groove Yield (N) ²	Ring Shear (N) ³
FH-065	65,00	68,70	5,08	2,41	68,00	2,65	47471	116517
FH-067	67,00	70,54	5,08	2,41	70,00	2,65	48939	120115
FH-068	68,00	71,84	5,08	2,41	71,00	2,65	49660	121890
FH-070	70,00	73,64	5,08	2,41	73,00	2,65	51128	125489
FH-072	72,00	75,72	5,08	2,41	75,00	2,65	52591	129083
FH-075	75,00	78,75	5,08	2,41	78,00	2,65	54780	134456
FH-076	76,00	79,88	5,08	2,41	79,00	2,65	55505	136231
FH-078	78,00	81,73	5,08	2,41	81,00	2,65	56968	139830
FH-080	80,00	84,30	6,02	2,41	83,50	2,65	68342	143428
FH-082	82,00	86,32	6,02	2,41	85,50	2,65	70033	146978
FH-085	85,00	89,35	6,30	2,91	88,50	3,15	72595	175046
FH-088	88,00	92,38	6,30	2,91	91,50	3,15	75175	181269
FH-090	90,00	94,70	6,30	2,91	93,50	3,15	76865	185353
FH-092	92,00	96,50	6,30	2,91	95,50	3,15	78582	189485
FH-095	95,00	99,62	6,30	2,91	98,50	3,15	81140	195659
FH-098	98,00	102,71	6,30	2,91	101,50	3,15	83702	201829
FH-100	100,00	104,50	6,30	2,91	103,50	3,15	85415	205962
FH-102	102,00	107,27	6,73	3,89	106,00	4,15	87127	269224
FH-105	105,00	109,96	6,73	3,89	109,00	4,15	102687	277133
FH-108	108,00	113,09	6,73	3,89	112,00	4,15	105619	285042
FH-110	110,00	115,10	6,73	3,89	114,00	4,15	107580	290340
FH-112	112,00	117,12	6,73	3,89	116,00	4,15	109520	295567
FH-115	115,00	120,15	6,73	3,89	119,00	4,15	112473	303547
FH-120	120,00	125,60	6,73	3,89	124,00	4,15	117344	316687
FH-125	125,00	130,25	6,73	3,89	129,00	4,15	122237	329893
FH-127	127,00	132,27	6,73	3,89	131,00	4,15	124199	335187
FH-130	130,00	135,30	6,73	3,89	134,00	4,15	127130	343096
FH-135	135,00	140,35	6,73	3,89	139,00	4,15	132023	356303
FH-140	140,00	145,26	6,73	3,89	144,00	4,15	136916	369509
FH-145	145,00	150,45	6,73	3,89	149,00	4,15	141809	382716
FH-150	150,00	156,50	8,03	3,89	155,00	4,15	181986	395923
FH-155	155,00	161,55	8,03	3,89	160,00	4,15	188026	409063
FH-160	160,00	166,60	8,03	3,89	165,00	4,15	194094	422270
FH-165	165,00	171,70	8,03	3,89	170,00	4,15	200166	435476
FH-170	170,00	176,70	8,03	3,89	175,00	4,15	206237	448683
FH-175	175,00	181,75	8,03	3,89	180,00	4,15	212305	461890
FH-180	180,00	186,80	8,03	3,89	185,00	4,15	218377	475097
FH-185	185,00	191,85	8,03	3,89	190,00	4,15	224417	488232
FH-190	190,00	197,15	8,03	3,89	195,00	4,15	230489	501439
FH-195	195,00	201,95	8,03	3,89	200,00	4,15	236556	514646
FH-200	200,00	207,00	8,03	3,89	205,00	4,15	242628	527853
FH-210	210,00	217,93	9,48	4,87	216,00	5,15	306763	657096
FH-220	220,00	228,20	9,48	4,87	226,00	5,15	321344	688327
FH-230	230,00	238,30	9,48	4,87	236,00	5,15	335961	719638
FH-240	240,00	248,40	9,48	4,87	246,00	5,15	350578	750953
FH-250	250,00	258,50	9,48	4,87	256,00	5,15	365199	782264
FH-260	260,00	270,77	11,05	4,87	268,00	5,15	505300	813500
FH-270	270,00	280,70	11,05	4,87	278,00	5,15	524748	844811
FH-280	280,00	290,57	11,05	4,87	288,00	5,15	544200	876126
FH-290	290,00	300,90	11,05	4,87	298,00	5,15	563599	907357
FH-300	300,00	311,00	11,05	4,87	308,00	5,15	583051	938673

¹ Add suffix "-S02" for 302 stainless steel.

² Based on a groove material yield strength of 310 N/mm² and a safety factor of 2.

³ Based on a safety factor of 3.

⁴ See pages 134 – 135 for How to Order.

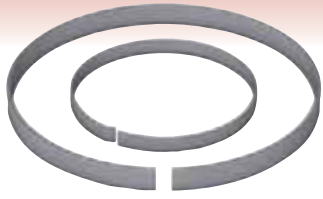

Stock Items available in carbon steel and 302 stainless steel.

Product Dimensions

All dimensions in millimeters unless otherwise specified.

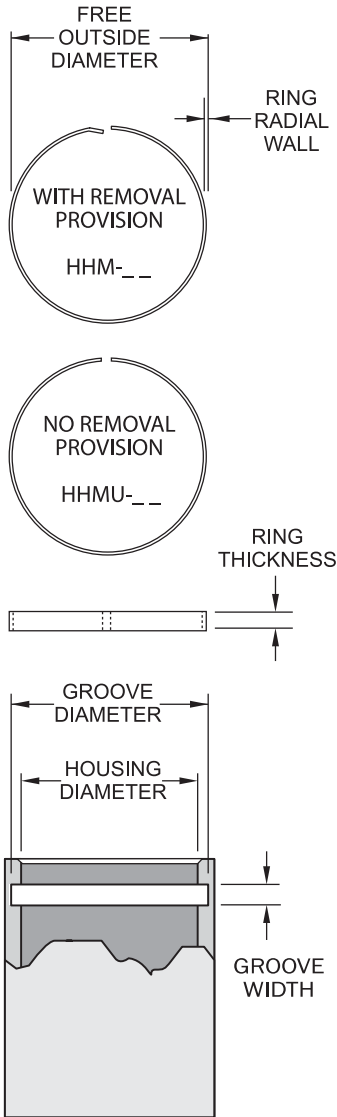

Internal Hoopster Retaining Rings are difficult to remove from the groove without a removal provision. We offer either a bent end for removal or no removal provision as shown to the left.

Smalley Part Number ^{1, 2, 4}	Housing Diameter	Ring			Groove		Groove Yield (N) ³
		Outside Diameter	Radial Wall	Thickness	Diameter ⁵	Width	
HHM-10	10	10,63	0,43	1,14	10,43	1,27	1052
HHM-11	11	11,65	0,43	1,14	11,43	1,27	1157
HHM-12	12	12,67	0,43	1,14	12,43	1,27	1263
HHM-13	13	13,79	0,53	1,65	13,53	1,78	1690
HHM-14	14	14,81	0,53	1,65	14,53	1,78	1820
HHM-15	15	15,83	0,53	1,65	15,53	1,78	1950
HHM-16	16	16,85	0,53	1,65	16,53	1,78	2080
HHM-17	17	17,87	0,53	1,65	17,53	1,78	2210
HHM-18	18	18,97	0,61	2,24	18,61	2,36	2674
HHM-19	19	19,99	0,61	2,24	19,61	2,36	2822
HHM-20	20	21,01	0,61	2,24	20,61	2,36	2971
HHM-21	21	22,03	0,61	2,24	21,61	2,36	3119
HHM-22	22	23,05	0,61	2,24	22,61	2,36	3268
HHM-23	23	24,07	0,61	2,24	23,61	2,36	3417
HHM-24	24	25,09	0,61	2,24	24,61	2,36	3565
HHM-25	25	26,11	0,61	2,24	25,61	2,36	3714
HHM-26	26	27,28	0,76	3,00	26,76	3,12	4828
HHM-27	27	28,30	0,76	3,00	27,76	3,12	5013
HHM-28	28	29,32	0,76	3,00	28,76	3,12	5199
HHM-29	29	30,34	0,76	3,00	29,76	3,12	5385
HHM-30	30	31,36	0,76	3,00	30,76	3,12	5570
HHM-31	31	32,38	0,76	3,00	31,76	3,12	5756
HHM-32	32	33,40	0,76	3,00	32,76	3,12	5942
HHM-33	33	34,52	0,86	3,81	33,86	3,94	6945
HHM-34	34	35,54	0,86	3,81	34,86	3,94	7155
HHM-35	35	36,56	0,86	3,81	35,86	3,94	7365
HHM-36	36	37,58	0,86	3,81	36,86	3,94	7576
HHM-37	37	38,60	0,86	3,81	37,86	3,94	7786
HHM-38	38	39,62	0,86	3,81	38,86	3,94	7997
HHM-40	40	41,66	0,86	3,81	40,86	3,94	8418
HHM-41	41	42,68	0,86	3,81	41,86	3,94	8628
HHM-42	42	43,70	0,86	3,81	42,86	3,94	8838
HHM-45	45	46,87	0,97	4,75	45,97	4,88	10584
HHM-47	47	48,91	0,97	4,75	47,97	4,88	11054
HHM-48	48	49,93	0,97	4,75	48,97	4,88	11289
HHM-50	50	51,97	0,97	4,75	50,97	4,88	11760
HHM-51	51	52,99	0,97	4,75	51,97	4,88	11995
HHM-52	52	54,01	0,97	4,75	52,97	4,88	12230
HHM-55	55	57,07	0,97	4,75	55,97	4,90	12936
HHM-56	56	58,09	0,97	4,75	56,97	4,90	13171
HHM-57	57	59,11	0,97	4,75	57,97	4,90	13406
HHM-58	58	60,13	0,97	4,75	58,97	4,90	13641
HHM-60	60	62,17	0,97	4,75	60,97	4,90	14112
HHM-62	62	64,38	1,14	5,72	63,14	5,87	17268
HHM-63	63	65,40	1,14	5,72	64,14	5,87	17547
HHM-64	64	66,42	1,14	5,72	65,14	5,87	17826
HHM-65	65	67,44	1,14	5,72	66,14	5,87	18104
HHM-67	67	69,48	1,14	5,72	68,14	5,87	18661
HHM-68	68	70,50	1,14	5,72	69,14	5,87	18940
HHM-70	70	72,54	1,14	5,72	71,14	5,87	19497
HHM-72	72	74,58	1,14	5,72	73,14	5,87	20054
HHM-75	75	77,64	1,14	5,72	76,14	5,87	20889
HHM-76	76	78,66	1,14	5,72	77,14	5,87	21168

¹ Use "HHM" prefix for removal provision end. Use "HHMU" prefix for no removal provision.

² Add suffix "-S02" for 302 stainless steel.

³ Based on a groove material yield strength of 310 N/mm² and a safety factor of 2

⁴ See pages 134-135 for How to Order.

⁵ Sharp corners on the groove required, see page 129 for more information.

Internal Hoopster Retaining Rings are difficult to remove from the groove without a removal provision. We offer either a bent end for removal or no removal provision as shown to the left.

Smalley Part Number ^{1,2,4}	Housing Diameter	Ring			Groove		Groove Yield (lb) ³	
		Outside Diameter	Radial Wall	Thickness	Diameter ⁵	Width		
HH-37	0,375	0,400	±0,012/-0,000	0,017	0,045	0,392	0,050	225
HH-43	0,437	0,463	±0,012/-0,000	0,017	0,045	0,454	0,050	263
HH-46	0,469	0,495	±0,012/-0,000	0,017	0,045	0,486	0,050	282
HH-50	0,500	0,531	±0,015/-0,000	0,021	0,065	0,521	0,070	371
HH-53	0,531	0,563	±0,015/-0,000	0,021	0,065	0,552	0,070	394
HH-56	0,562	0,594	±0,015/-0,000	0,021	0,065	0,583	0,070	417
HH-59	0,594	0,627	±0,015/-0,000	0,021	0,065	0,615	0,070	441
HH-62	0,625	0,659	±0,015/-0,000	0,021	0,065	0,646	0,070	464
HH-65	0,656	0,690	±0,015/-0,000	0,021	0,065	0,677	0,070	487
HH-68	0,688	0,723	±0,015/-0,000	0,021	0,065	0,709	0,070	511
HH-71	0,718	0,756	±0,015/-0,000	0,024	0,088	0,742	0,093	609
HH-75	0,750	0,789	±0,015/-0,000	0,024	0,088	0,774	0,093	636
HH-78	0,781	0,821	±0,015/-0,000	0,024	0,088	0,805	0,093	662
HH-81	0,812	0,852	±0,015/-0,000	0,024	0,088	0,836	0,093	689
HH-84	0,843	0,884	±0,015/-0,000	0,024	0,088	0,867	0,093	715
HH-87	0,875	0,917	±0,015/-0,000	0,024	0,088	0,899	0,093	742
HH-90	0,906	0,948	±0,015/-0,000	0,024	0,088	0,930	0,093	768
HH-93	0,938	0,981	±0,015/-0,000	0,024	0,088	0,962	0,093	796
HH-96	0,968	1,011	±0,015/-0,000	0,024	0,088	0,992	0,093	821
HH-100	1,000	1,044	±0,015/-0,000	0,024	0,088	1,024	0,093	848
HH-103	1,031	1,082	±0,015/-0,000	0,030	0,118	1,061	0,123	1093
HH-106	1,062	1,113	±0,015/-0,000	0,030	0,118	1,092	0,123	1126
HH-109	1,093	1,145	±0,015/-0,000	0,030	0,118	1,123	0,123	1159
HH-112	1,125	1,178	±0,015/-0,000	0,030	0,118	1,155	0,123	1193
HH-115	1,156	1,209	±0,015/-0,000	0,030	0,118	1,186	0,123	1226
HH-118	1,188	1,242	±0,015/-0,000	0,030	0,118	1,218	0,123	1260
HH-121	1,218	1,272	±0,015/-0,000	0,030	0,118	1,248	0,123	1291
HH-125	1,250	1,305	±0,015/-0,000	0,030	0,118	1,280	0,123	1325
HH-128	1,281	1,337	±0,015/-0,000	0,030	0,118	1,311	0,123	1358
HH-131	1,312	1,372	±0,015/-0,000	0,034	0,150	1,346	0,155	1577
HH-134	1,343	1,404	±0,015/-0,000	0,034	0,150	1,377	0,155	1614
HH-137	1,375	1,437	±0,015/-0,000	0,034	0,150	1,409	0,155	1652
HH-140	1,406	1,468	±0,015/-0,000	0,034	0,150	1,440	0,155	1690
HH-143	1,437	1,500	±0,015/-0,000	0,034	0,150	1,471	0,155	1727
HH-146	1,468	1,531	±0,015/-0,000	0,034	0,150	1,502	0,155	1765
HH-150	1,500	1,564	±0,015/-0,000	0,034	0,150	1,534	0,155	1802
HH-156	1,562	1,627	±0,015/-0,000	0,034	0,150	1,596	0,155	1877
HH-162	1,625	1,692	±0,015/-0,000	0,034	0,150	1,659	0,155	1953
HH-168	1,688	1,755	±0,015/-0,000	0,034	0,150	1,721	0,155	2028
HH-175	1,750	1,823	±0,015/-0,000	0,038	0,187	1,788	0,193	2350
HH-181	1,812	1,887	±0,015/-0,000	0,038	0,187	1,851	0,193	2434
HH-187	1,875	1,951	±0,015/-0,000	0,038	0,187	1,913	0,193	2518
HH-193	1,938	2,015	±0,015/-0,000	0,038	0,187	1,976	0,193	2603
HH-200	2,000	2,078	±0,015/-0,000	0,038	0,187	2,038	0,193	2686
HH-206	2,062	2,141	±0,015/-0,000	0,038	0,187	2,100	0,193	2769
HH-212	2,125	2,206	±0,015/-0,000	0,038	0,187	2,163	0,193	2854
HH-218	2,188	2,270	±0,015/-0,000	0,038	0,187	2,226	0,193	2939
HH-225	2,250	2,333	±0,015/-0,000	0,038	0,187	2,288	0,193	3022
HH-231	2,312	2,396	±0,015/-0,000	0,038	0,187	2,350	0,193	3105
HH-237	2,375	2,461	±0,015/-0,000	0,038	0,187	2,413	0,193	3190
HH-243	2,437	2,531	±0,015/-0,000	0,045	0,225	2,482	0,232	3876
HH-250	2,500	2,595	±0,015/-0,000	0,045	0,225	2,545	0,232	3976
HH-256	2,562	2,658	±0,015/-0,000	0,045	0,225	2,607	0,232	4075
HH-262	2,625	2,723	±0,015/-0,000	0,045	0,225	2,670	0,232	4175
HH-268	2,688	2,787	±0,015/-0,000	0,045	0,225	2,733	0,232	4275
HH-275	2,750	2,850	±0,015/-0,000	0,045	0,225	2,795	0,232	4374
HH-281	2,812	2,914	±0,015/-0,000	0,045	0,225	2,858	0,232	4472
HH-287	2,875	2,978	±0,015/-0,000	0,045	0,225	2,920	0,232	4572
HH-293	2,938	3,041	±0,015/-0,000	0,045	0,225	2,982	0,232	4673
HH-300	3,000	3,105	±0,015/-0,000	0,045	0,225	3,045	0,232	4771

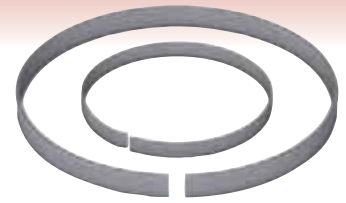

Stock Items available in carbon steel and 302 stainless steel.

Product Dimensions

All dimensions in inches unless otherwise specified.

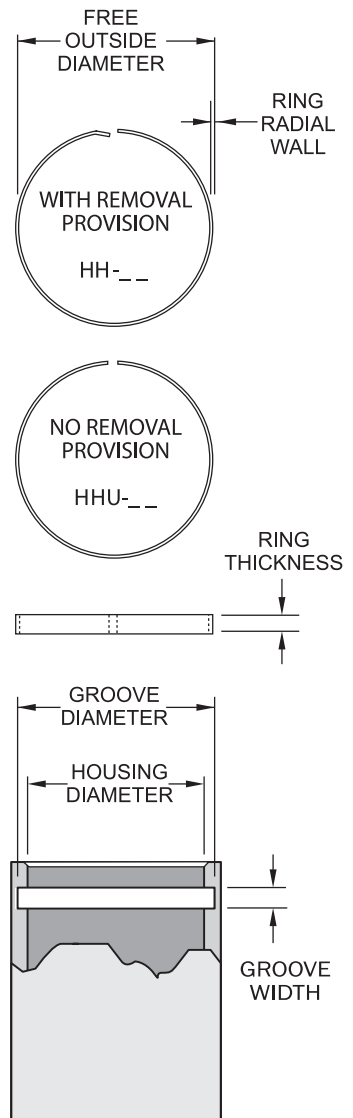

¹ Use "HH" prefix for removal provision end. Use "HHU" prefix for no removal provision.

² Add suffix "-S02" for 302 stainless steel.

³ Based on a groove material yield strength of 45,000 psi and a safety factor of 2.

⁴ See pages 134 – 135 for How to Order.

⁵ Sharp corners on the groove required, see page 129 for more information.

⁶ 1 lb = 4,448 N

1 psi = 0,0069 N/mm²

1 inch = 25,4 mm

Stock Items available in carbon steel and 302 and 316 stainless steel.

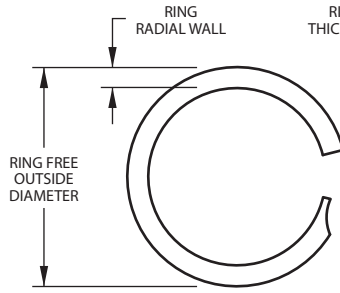
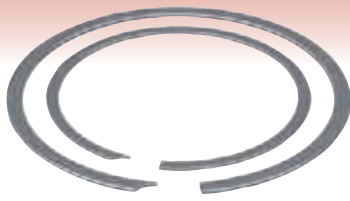

*No removal notch

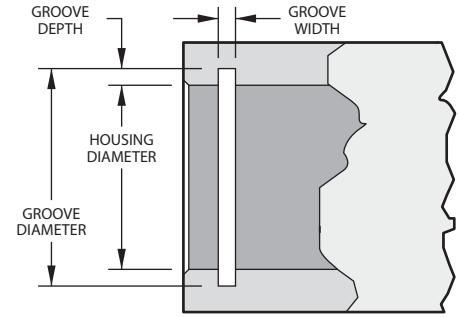

Product Dimensions All dimensions in inches unless otherwise specified.

Smalley Part Number ^{1,4}	Housing Diameter	Ring			Groove		Thrust Capacity	
		Outside Diameter	Radial Wall	Thickness	Diameter	Width	Groove Yield (lb) ²	Ring Shear (lb) ³
VH-25*	0,250	0,264	0,020	0,012	0,262	0,015	106	481
VH-31*	0,312	0,329	0,025	0,015	0,326	0,018	154	750
VH-37*	0,375	0,398	0,030	0,015	0,395	0,018	265	901
VH-43	0,437	0,466	0,030	0,015	0,463	0,018	402	1050
VH-50	0,500	0,531	0,045	0,018	0,528	0,022	500	1300
VH-56	0,562	0,593	0,045	0,018	0,590	0,022	560	1460
VH-62	0,625	0,656	0,045	0,018	0,653	0,022	620	1630
VH-68	0,687	0,719	0,045	0,018	0,715	0,022	680	1790
VH-75	0,750	0,783	0,045	0,018	0,779	0,022	800	1950
VH-81	0,812	0,862	0,065	0,021	0,854	0,026	1210	2460
VH-87	0,875	0,926	0,065	0,021	0,917	0,026	1300	2660
VH-93	0,937	0,989	0,065	0,021	0,979	0,026	1390	2840
VH-100	1,000	1,052	0,065	0,021	1,042	0,026	1480	3040
VH-106	1,062	1,117	0,088	0,025	1,106	0,031	1650	3500
VH-112	1,125	1,180	0,088	0,025	1,169	0,031	1750	3710
VH-118	1,187	1,242	0,088	0,025	1,231	0,031	1850	3920
VH-125	1,250	1,307	0,088	0,025	1,294	0,031	1940	4120
VH-131	1,312	1,369	0,088	0,025	1,356	0,031	2040	4330
VH-137	1,375	1,433	0,088	0,025	1,419	0,031	2140	4540
VH-143	1,437	1,496	0,088	0,025	1,481	0,031	2240	4740
VH-150	1,500	1,559	0,088	0,025	1,544	0,031	2330	4950
VH-156	1,562	1,637	0,118	0,031	1,619	0,039	3200	6390
VH-162	1,625	1,701	0,118	0,031	1,682	0,039	3330	6650
VH-168	1,687	1,763	0,118	0,031	1,744	0,039	3460	6900
VH-175	1,750	1,827	0,118	0,031	1,807	0,039	3590	7160
VH-181	1,812	1,890	0,118	0,031	1,869	0,039	3710	7410
VH-187	1,875	1,953	0,118	0,031	1,932	0,039	3840	7670
VH-193	1,937	2,016	0,118	0,031	1,994	0,039	3970	7920
VH-200	2,000	2,079	0,118	0,031	2,057	0,039	4100	8180
VH-206	2,062	2,162	0,158	0,031	2,138	0,039	5540	8430
VH-212	2,125	2,226	0,158	0,031	2,201	0,039	5710	8690
VH-218	2,187	2,289	0,158	0,031	2,263	0,039	5870	8950
VH-225	2,250	2,352	0,158	0,031	2,326	0,039	6040	9200
VH-231	2,312	2,415	0,158	0,031	2,388	0,039	6210	9460
VH-237	2,375	2,478	0,158	0,031	2,451	0,039	6380	9720
VH-243	2,437	2,541	0,158	0,031	2,513	0,039	6550	9970
VH-250	2,500	2,605	0,158	0,031	2,576	0,039	6720	10230
VH-256	2,562	2,667	0,158	0,031	2,638	0,039	6880	10480
VH-262	2,625	2,731	0,158	0,031	2,701	0,039	7050	10740
VH-268	2,687	2,794	0,158	0,031	2,763	0,039	7220	10990
VH-275	2,750	2,857	0,158	0,031	2,826	0,039	7390	11250
VH-281	2,812	2,920	0,158	0,031	2,888	0,039	7550	11500
VH-287	2,875	2,983	0,158	0,031	2,951	0,039	7720	11760
VH-293	2,937	3,046	0,158	0,031	3,013	0,039	7890	12010
VH-300	3,000	3,110	0,158	0,031	3,076	0,039	8060	12270

¹ Add suffix "-S02" for 302 stainless steel, "-S16" for 316 stainless steel.

² Based on a groove material yield strength of 45,000 psi and a safety factor of 2.

³ Based on a safety factor of 3.

⁴ See pages 134 - 135 for How to Order.

⁵ 1 lb = 4,448 N

1 psi = 0,0069 N/mm²

1 inch = 25,4 mm

Product Dimensions All dimensions in inches unless otherwise specified.

Smalley Part Number ^{1,4}	Housing Diameter	Ring			Groove		Thrust Capacity	
		Outside Diameter	Radial Wall	Thickness	Diameter	Width	Groove Yield (lb) ²	Ring Shear (lb) ³
VH-306	3,062	3,188	0,188	0,039	3,154	0,044	9960	15760
VH-312	3,125	3,251	0,188	0,039	3,217	0,044	10160	16080
VH-318	3,187	3,314	0,188	0,039	3,279	0,044	10360	16400
VH-325	3,250	3,377	0,188	0,039	3,342	0,044	10570	16720
VH-331	3,312	3,440	0,188	0,039	3,404	0,044	10770	17040
VH-337	3,375	3,504	0,188	0,039	3,467	0,044	10970	17370
VH-343	3,437	3,566	0,188	0,039	3,529	0,044	11180	17690
VH-350	3,500	3,630	0,188	0,039	3,592	0,044	11380	18010
VH-356	3,562	3,692	0,188	0,039	3,654	0,044	11580	18330
VH-362	3,625	3,756	0,188	0,039	3,717	0,044	11790	18650
VH-368	3,687	3,819	0,188	0,039	3,779	0,044	11990	18970
VH-375	3,750	3,882	0,188	0,039	3,842	0,044	12190	19300
VH-381	3,812	3,945	0,188	0,039	3,904	0,044	12400	19620
VH-387	3,875	4,009	0,188	0,039	3,967	0,044	12600	19940
VH-393	3,937	4,071	0,188	0,039	4,029	0,044	12800	20260
VH-400	4,000	4,135	0,188	0,039	4,092	0,044	13010	20580
VH-412	4,125	4,279	0,225	0,046	4,235	0,052	16040	23850
VH-425	4,250	4,405	0,225	0,046	4,360	0,052	16520	24570
VH-437	4,375	4,531	0,225	0,046	4,485	0,052	17010	25290
VH-450	4,500	4,658	0,225	0,046	4,610	0,052	17500	26010
VH-462	4,625	4,784	0,225	0,046	4,735	0,052	17980	26740
VH-475	4,750	4,910	0,225	0,046	4,860	0,052	18470	27460
VH-487	4,875	5,036	0,225	0,046	4,985	0,052	18950	28180
VH-500	5,000	5,163	0,225	0,046	5,110	0,052	19440	28900
VH-525	5,250	5,435	0,225	0,061	5,381	0,067	24490	40240
VH-550	5,500	5,694	0,225	0,061	5,638	0,067	26830	42160
VH-575	5,750	5,953	0,225	0,061	5,894	0,067	29260	44080
VH-600	6,000	6,212	0,265	0,061	6,150	0,067	31810	45990
VH-625	6,250	6,470	0,265	0,061	6,406	0,067	34460	47910
VH-650	6,500	6,730	0,265	0,061	6,663	0,067	37680	49830
VH-675	6,750	6,988	0,265	0,061	6,919	0,067	40560	51740
VH-700	7,000	7,247	0,265	0,061	7,175	0,067	43540	53660
VH-725	7,250	7,505	0,265	0,061	7,431	0,067	46640	55580
VH-750	7,500	7,765	0,265	0,061	7,688	0,067	49830	57490
VH-775	7,750	8,023	0,300	0,061	7,944	0,067	53140	59410
VH-800	8,000	8,282	0,300	0,061	8,200	0,067	56550	61320
VH-825	8,250	8,541	0,300	0,061	8,456	0,067	60070	63240
VH-850	8,500	8,800	0,300	0,061	8,713	0,067	64290	65160
VH-875	8,750	9,059	0,345	0,076	8,969	0,082	68040	67080
VH-900	9,000	9,317	0,345	0,076	9,225	0,082	71890	68990
VH-925	9,250	9,576	0,345	0,076	9,481	0,082	75850	70900
VH-950	9,500	9,835	0,345	0,076	9,738	0,082	79910	72810
VH-975	9,750	10,094	0,345	0,076	9,994	0,082	84080	74720
VH-1000	10,000	10,353	0,345	0,076	10,250	0,082	88360	76630

¹ Add suffix "-S02" for 302 stainless steel, "-S16" for 316 stainless steel.

² Based on a groove material yield strength of 45,000 psi and a safety factor of 2.

³ Based on a safety factor of 3.

⁴ See pages 134 –135 for How to Order.

⁵ 1 lb = 4,448 N

1 psi = 0,0069 N/mm²

1 inch = 25,4 mm

Stock Items available in carbon steel and 302 and 316 stainless steel.

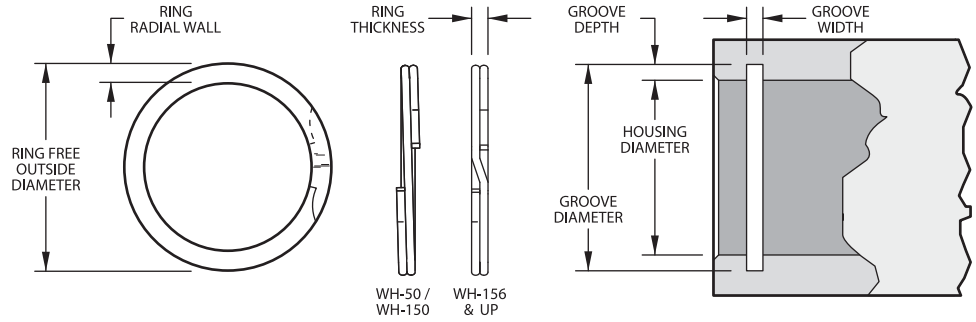

AS3217, AS4299
MIL-DTL-27426/3

Product Dimensions All dimensions in inches unless otherwise specified.

Smalley Part Number ^{1,4}	Housing Diameter	Ring			Groove		Thrust Capacity	
		Outside Diameter	Radial Wall	Thickness	Diameter	Width	Groove Yield (lb) ²	Ring Shear (lb) ³
WH-50	0,500	0,532	0,045	0,025	0,526	0,030	460	2000
WH-51	0,512	0,544	0,045	0,025	0,538	0,030	470	2050
WH-53	0,531	0,564	0,045	0,025	0,557	0,030	490	2130
WH-56	0,562	0,594	0,045	0,025	0,588	0,030	520	2250
WH-59	0,594	0,626	0,045	0,025	0,619	0,030	550	2380
WH-62	0,625	0,658	0,045	0,025	0,651	0,030	570	2500
WH-65	0,656	0,689	0,045	0,025	0,682	0,030	600	2630
WH-68	0,687	0,720	0,045	0,025	0,713	0,030	630	2750
WH-71	0,718	0,751	0,045	0,025	0,744	0,030	660	2870
WH-75	0,750	0,790	0,065	0,031	0,782	0,036	850	3360
WH-77	0,777	0,817	0,065	0,031	0,808	0,036	880	3480
WH-78	0,781	0,821	0,065	0,031	0,812	0,036	880	3500
WH-81	0,812	0,853	0,065	0,031	0,843	0,036	920	3640
WH-84	0,843	0,889	0,065	0,031	0,880	0,036	1130	3780
WH-86	0,866	0,913	0,065	0,031	0,903	0,036	1160	3880
WH-87	0,875	0,922	0,065	0,031	0,912	0,036	1180	3920
WH-90	0,906	0,949	0,065	0,031	0,939	0,036	1220	4060
WH-93	0,938	0,986	0,065	0,031	0,975	0,036	1260	4200
WH-96	0,968	1,025	0,075	0,037	1,015	0,042	1440	5180
WH-98	0,987	1,041	0,075	0,037	1,030	0,042	1470	5280
WH-100	1,000	1,054	0,075	0,037	1,043	0,042	1480	5350
WH-102	1,023	1,078	0,075	0,037	1,066	0,042	1520	5470
WH-103	1,031	1,084	0,075	0,037	1,074	0,042	1530	5510
WH-106	1,062	1,117	0,075	0,037	1,104	0,042	1580	5680
WH-109	1,093	1,147	0,075	0,037	1,135	0,042	1620	5840
WH-112	1,125	1,180	0,075	0,037	1,167	0,042	1670	6020
WH-115	1,156	1,210	0,075	0,037	1,198	0,042	1720	6180
WH-118	1,188	1,249	0,085	0,043	1,236	0,048	2020	7380
WH-121	1,218	1,278	0,085	0,043	1,266	0,048	2070	7570
WH-125	1,250	1,312	0,085	0,043	1,298	0,048	2120	7770
WH-128	1,281	1,342	0,085	0,043	1,329	0,048	2170	7960
WH-131	1,312	1,374	0,085	0,043	1,360	0,048	2230	8150
WH-134	1,343	1,408	0,085	0,043	1,395	0,048	2470	8350
WH-137	1,375	1,442	0,095	0,043	1,427	0,048	2530	8540
WH-140	1,406	1,472	0,095	0,043	1,458	0,048	2580	8740
WH-143	1,437	1,504	0,095	0,043	1,489	0,048	2640	8930
WH-145	1,456	1,523	0,095	0,043	1,508	0,048	2680	9050
WH-146	1,468	1,535	0,095	0,043	1,520	0,048	2700	9120
WH-150	1,500	1,567	0,095	0,043	1,552	0,048	2760	9320
WH-156	1,562	1,634	0,108	0,049	1,617	0,056	3090	10100
WH-157	1,574	1,649	0,108	0,049	1,633	0,056	3340	10180
WH-162	1,625	1,701	0,108	0,049	1,684	0,056	3350	10510
WH-165	1,653	1,730	0,108	0,049	1,712	0,056	3510	10690
WH-168	1,687	1,768	0,118	0,049	1,750	0,056	3700	10910
WH-175	1,750	1,834	0,118	0,049	1,813	0,056	3840	11310
WH-181	1,813	1,894	0,118	0,049	1,875	0,056	3970	11720
WH-185	1,850	1,937	0,118	0,049	1,917	0,056	4450	11960

¹ Add suffix "-S02" for 302 stainless steel, "-S16" for 316 stainless steel.

² Based on a groove material yield strength of 45,000 psi and a safety factor of 2.

³ Based on a safety factor of 3.

⁴ See pages 134 -135 for How to Order.

⁵ 1 lb = 4,448 N

1 psi = 0,0069 N/mm²

1 inch = 25,4 mm

Smalley Part Number ^{1,4}	Housing Diameter	Ring			Groove		Thrust Capacity	
		Outside Diameter	Radial Wall	Thickness	Diameter	Width	Groove Yield (lb) ²	Ring Shear (lb) ³
WH-187	1,875	1,960	0,118	0,049	1,942	0,056	4510	12120
WH-193	1,938	2,025	0,118	0,049	2,005	0,056	4660	12530
WH-200	2,000	2,091	0,128	0,049	2,071	0,056	4950	12930
WH-204	2,047	2,138	0,128	0,049	2,118	0,056	5060	13240
WH-206	2,062	2,154	0,128	0,049	2,132	0,056	5100	13330
WH-212	2,125	2,217	0,128	0,049	2,195	0,056	5260	13740
WH-216	2,165	2,260	0,138	0,049	2,239	0,056	5660	14000
WH-218	2,188	2,284	0,138	0,049	2,262	0,056	5720	14150
WH-225	2,250	2,347	0,138	0,049	2,324	0,056	5890	14550
WH-231	2,312	2,413	0,138	0,049	2,390	0,056	6370	14950
WH-237	2,375	2,476	0,138	0,049	2,453	0,056	6550	15360
WH-243	2,437	2,543	0,148	0,049	2,519	0,056	7060	15760
WH-244	2,440	2,546	0,148	0,049	2,522	0,056	7070	15780
WH-250	2,500	2,606	0,148	0,049	2,582	0,056	7250	16160
WH-253	2,531	2,641	0,148	0,049	2,617	0,056	7690	16360
WH-256	2,562	2,673	0,148	0,049	2,648	0,056	7790	16560
WH-262	2,625	2,736	0,148	0,049	2,711	0,056	7980	16970
WH-267	2,677	2,789	0,158	0,049	2,767	0,056	8520	17310
WH-268	2,688	2,803	0,158	0,049	2,778	0,056	8550	17380
WH-275	2,750	2,865	0,158	0,049	2,841	0,056	8750	17780
WH-281	2,813	2,929	0,158	0,049	2,903	0,056	8950	18190
WH-283	2,834	2,954	0,168	0,049	2,928	0,056	9520	18320
WH-287	2,875	2,995	0,168	0,049	2,969	0,056	9550	18590
WH-293	2,937	3,058	0,168	0,049	3,031	0,056	9760	18990
WH-295	2,952	3,073	0,168	0,049	3,046	0,056	9810	19090
WH-300	3,000	3,122	0,168	0,061	3,096	0,068	10180	24150
WH-306	3,062	3,186	0,168	0,061	3,158	0,068	10390	24650
WH-312	3,125	3,251	0,178	0,061	3,223	0,068	10600	25150
WH-314	3,149	3,276	0,178	0,061	3,247	0,068	10680	25350
WH-318	3,187	3,311	0,178	0,061	3,283	0,068	10810	25650
WH-325	3,250	3,379	0,178	0,061	3,350	0,068	11490	26160
WH-331	3,312	3,446	0,188	0,061	3,416	0,068	12170	26660
WH-334	3,346	3,479	0,188	0,061	3,450	0,068	12300	26930
WH-337	3,375	3,509	0,188	0,061	3,479	0,068	12410	27170
WH-343	3,437	3,574	0,188	0,061	3,543	0,068	12880	27660
WH-350	3,500	3,636	0,188	0,061	3,606	0,068	13110	28170
WH-354	3,543	3,684	0,198	0,061	3,653	0,068	13770	28520
WH-356	3,562	3,703	0,198	0,061	3,672	0,068	13850	28670
WH-362	3,625	3,769	0,198	0,061	3,737	0,068	14350	29180
WH-368	3,687	3,832	0,198	0,061	3,799	0,068	14600	29680
WH-374	3,740	3,885	0,198	0,061	3,852	0,068	14800	30100
WH-375	3,750	3,894	0,198	0,061	3,862	0,068	14840	30180
WH-381	3,812	3,963	0,208	0,061	3,930	0,068	15900	30680
WH-387	3,875	4,025	0,208	0,061	3,993	0,068	16160	31190
WH-393	3,938	4,089	0,208	0,061	4,056	0,068	16420	31700
WH-400	4,000	4,157	0,218	0,061	4,124	0,068	17530	32200
WH-406	4,063	4,222	0,218	0,061	4,187	0,068	17810	32700
WH-412	4,125	4,284	0,218	0,061	4,249	0,068	18080	33200
WH-418	4,188	4,347	0,218	0,061	4,311	0,068	18350	33710
WH-425	4,250	4,416	0,228	0,061	4,380	0,068	19530	34210
WH-431	4,312	4,479	0,228	0,061	4,442	0,068	19810	34710
WH-433	4,330	4,497	0,228	0,061	4,460	0,068	19900	34850
WH-437	4,375	4,543	0,228	0,061	4,505	0,068	20100	35210
WH-443	4,437	4,611	0,238	0,061	4,573	0,068	21330	35710
WH-450	4,500	4,674	0,238	0,061	4,636	0,068	21630	36220
WH-452	4,527	4,701	0,238	0,061	4,663	0,068	21760	36440
WH-456	4,562	4,737	0,238	0,061	4,698	0,068	21930	36720
WH-462	4,625	4,803	0,250	0,072	4,765	0,079	22890	43940
WH-468	4,687	4,867	0,250	0,072	4,827	0,079	23190	44530
WH-472	4,724	4,903	0,250	0,072	4,864	0,079	23370	44880
WH-475	4,750	4,930	0,250	0,072	4,890	0,079	23500	45130
WH-481	4,812	4,993	0,250	0,072	4,952	0,079	23810	45720

¹ Add suffix "-S02" for 302 stainless steel, "-S16" for 316 stainless steel.

² Based on a groove material yield strength of 45,000 psi and a safety factor of 2.

³ Based on a safety factor of 3.

⁴ See pages 134 –135 for How to Order.

⁵ 1 lb = 4,448 N

1 psi = 0,0069 N/mm²

1 inch = 25,4 mm

Stock Items available in carbon steel and 302 and 316 stainless steel.

Product Dimensions All dimensions in inches unless otherwise specified.

Smalley Part Number ^{1,4}	Housing Diameter	Ring			Groove		Thrust Capacity	
		Outside Diameter	Radial Wall	Thickness	Diameter	Width	Groove Yield (lb) ²	Ring Shear (lb) ³
WH-487	4,875	5,055	0,250	0,072	5,015	0,079	24120	46310
WH-492	4,921	5,102	0,250	0,072	5,061	0,079	24350	46750
WH-493	4,937	5,122	0,250	0,072	5,081	0,079	25130	46900
WH-500	5,000	5,185	0,250	0,072	5,144	0,079	25450	47500
WH-511	5,118	5,304	0,250	0,072	5,262	0,079	26050	48620
WH-512	5,125	5,311	0,250	0,072	5,269	0,079	26100	48690
WH-525	5,250	5,436	0,250	0,072	5,393	0,079	26720	49880
WH-537	5,375	5,566	0,250	0,072	5,522	0,079	28120	51060
WH-550	5,500	5,693	0,250	0,072	5,647	0,079	28770	52250
WH-551	5,511	5,703	0,250	0,072	5,658	0,079	28830	52360
WH-562	5,625	5,818	0,250	0,072	5,772	0,079	29400	53440
WH-570	5,708	5,909	0,250	0,072	5,861	0,079	31070	54230
WH-575	5,750	5,950	0,250	0,072	5,903	0,079	31300	54630
WH-587	5,875	6,077	0,250	0,072	6,028	0,079	31980	55810
WH-590	5,905	6,106	0,250	0,072	6,058	0,079	32140	56100
WH-600	6,000	6,202	0,250	0,072	6,153	0,079	32660	57000
WH-612	6,125	6,349	0,312	0,086	6,297	0,094	37200	69500
WH-625	6,250	6,474	0,312	0,086	6,422	0,094	37990	70920
WH-629	6,299	6,524	0,312	0,086	6,471	0,094	38290	71480
WH-637	6,375	6,601	0,312	0,086	6,547	0,094	38750	72340
WH-650	6,500	6,726	0,312	0,086	6,672	0,094	39510	73760
WH-662	6,625	6,863	0,312	0,086	6,807	0,094	42620	75180
WH-669	6,692	6,931	0,312	0,086	6,874	0,094	43050	75940
WH-675	6,750	6,987	0,312	0,086	6,932	0,094	43420	76600
WH-687	6,875	7,114	0,312	0,086	7,057	0,094	44220	78010
WH-700	7,000	7,239	0,312	0,086	7,182	0,094	45030	79430
WH-708	7,086	7,337	0,312	0,086	7,278	0,094	48080	80410
WH-712	7,125	7,376	0,312	0,086	7,317	0,094	48350	80850
WH-725	7,250	7,501	0,312	0,086	7,442	0,094	49200	82270
WH-737	7,375	7,628	0,312	0,086	7,567	0,094	50050	83690
WH-748	7,480	7,734	0,312	0,086	7,672	0,094	50760	84880
WH-750	7,500	7,754	0,312	0,086	7,692	0,094	50890	85110
WH-762	7,625	7,890	0,312	0,086	7,827	0,094	54440	86520
WH-775	7,750	8,014	0,312	0,086	7,952	0,094	55330	87940
WH-787	7,875	8,131	0,312	0,086	8,077	0,094	63360	89360
WH-800	8,000	8,266	0,312	0,086	8,202	0,094	57110	90780
WH-825	8,250	8,528	0,375	0,086	8,462	0,094	61820	93620
WH-826	8,267	8,546	0,375	0,086	8,479	0,094	61940	93810
WH-846	8,464	8,744	0,375	0,086	8,676	0,094	63420	96050
WH-850	8,500	8,780	0,375	0,086	8,712	0,094	63690	96450
WH-875	8,750	9,041	0,375	0,086	8,972	0,094	68650	99290
WH-885	8,858	9,151	0,375	0,086	9,080	0,094	69500	100520
WH-900	9,000	9,293	0,375	0,086	9,222	0,094	70620	102130
WH-905	9,055	9,359	0,375	0,086	9,287	0,094	74250	102750
WH-925	9,250	9,555	0,375	0,086	9,482	0,094	75850	104960
WH-944	9,448	9,755	0,375	0,086	9,680	0,094	77470	107210
WH-950	9,500	9,806	0,375	0,086	9,732	0,094	77900	107800
WH-975	9,750	10,068	0,375	0,086	9,992	0,094	83390	110640
WH-1000	10,000	10,320	0,375	0,086	10,242	0,094	85530	113470
WH-1025	10,250	10,582	0,375	0,086	10,502	0,094	91290	116310
WH-1050	10,500	10,834	0,375	0,086	10,752	0,094	93520	119150
WH-1075	10,750	11,095	0,375	0,086	11,012	0,094	99540	121990
WH-1100	11,000	11,347	0,375	0,086	11,262	0,094	101860	124820

¹ Add suffix "-S02" for 302 stainless steel, "-S16" for 316 stainless steel.

² Based on a groove material yield strength of 45,000 psi and a safety factor of 2.

³ Based on a safety factor of 3.

⁴ See pages 134 – 135 for How to Order.

⁵ 1 lb = 4,448 N

1 psi = 0,0069 N/mm²

1 inch = 25,4 mm

Stock Items available in carbon steel and 17-7PH stainless steel.

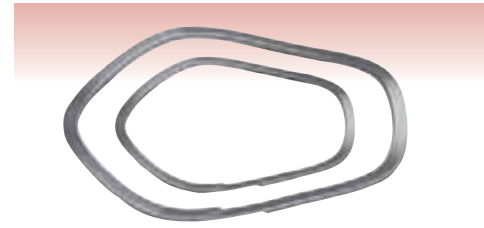
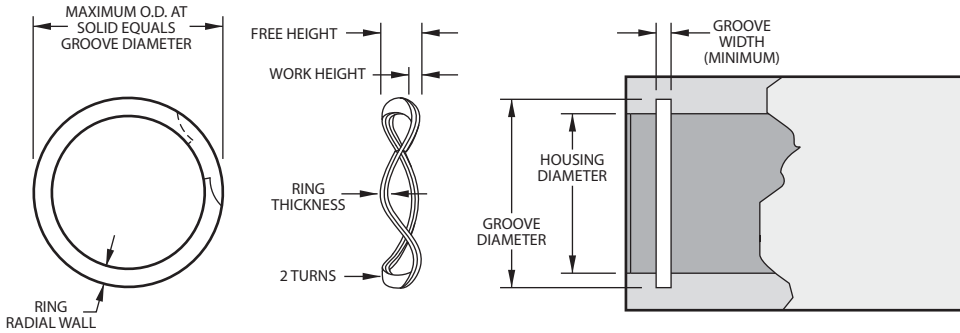

Product Dimensions All dimensions in inches unless otherwise specified.

Smalley Part Number ^{1,2}	Housing Diameter	Load (lb) @ Work Height	Max. Free Height	Number of Waves	Ring			Groove	
					Thickness	Radial Wall	Crimp	Diameter	Width Min.
WHW-75	0,750	25 @ 0,080	0,114	3	0,035	0,065	N	0,796	0,119
WHW-87	0,875	30 @ 0,085	0,110	3	0,042	0,085	N	0,931	0,115
WHW-100	1,000	34 @ 0,085	0,120	3	0,042	0,085	N	1,066	0,125
WHW-112	1,125	38 @ 0,100	0,125	3	0,050	0,128	N	1,197	0,130
WHW-125	1,250	40 @ 0,100	0,135	3	0,050	0,128	N	1,330	0,140
WHW-137	1,375	45 @ 0,100	0,125	4	0,050	0,128	N	1,461	0,130
WHW-150	1,500	50 @ 0,100	0,135	4	0,050	0,128	N	1,594	0,140
WHW-162	1,625	55 @ 0,110	0,135	4	0,062	0,158	N	1,725	0,140
WHW-175	1,750	60 @ 0,110	0,140	4	0,062	0,158	N	1,858	0,145
WHW-187	1,875	63 @ 0,110	0,141	4	0,062	0,158	N	1,989	0,146
WHW-200	2,000	65 @ 0,110	0,150	4	0,062	0,158	N	2,122	0,155
WHW-212	2,125	70 @ 0,130	0,170	4	0,078	0,188	N	2,251	0,175
WHW-225	2,250	75 @ 0,130	0,175	4	0,078	0,188	N	2,382	0,180
WHW-237	2,375	80 @ 0,130	0,180	4	0,078	0,188	N	2,517	0,185
WHW-250	2,500	84 @ 0,130	0,183	4	0,078	0,188	N	2,648	0,188
WHW-262	2,625	88 @ 0,170	0,220	4	0,093	0,225	N	2,781	0,225
WHW-275	2,750	94 @ 0,170	0,229	4	0,093	0,225	N	2,914	0,234
WHW-287	2,875	97 @ 0,170	0,225	4	0,093	0,225	N	3,051	0,230
WHW-300	3,000	100 @ 0,170	0,230	4	0,093	0,225	N	3,182	0,235
WHW-312	3,125	103 @ 0,185	0,250	4	0,111	0,281	Y	3,315	0,255
WHW-325	3,250	106 @ 0,185	0,250	4	0,111	0,281	Y	3,446	0,255
WHW-350	3,500	115 @ 0,185	0,245	4	0,111	0,281	Y	3,710	0,250
WHW-362	3,625	117 @ 0,185	0,250	4	0,111	0,281	Y	3,841	0,250
WHW-375	3,750	121 @ 0,185	0,255	4	0,111	0,312	Y	3,974	0,260
WHW-387	3,875	126 @ 0,185	0,260	4	0,111	0,312	Y	4,107	0,265
WHW-400	4,000	130 @ 0,185	0,255	4	0,111	0,312	Y	4,240	0,260
WHW-412	4,125	134 @ 0,185	0,258	4	0,111	0,312	Y	4,365	0,263
WHW-425	4,250	140 @ 0,185	0,264	4	0,111	0,312	Y	4,490	0,269
WHW-450	4,500	150 @ 0,185	0,250	5	0,111	0,312	Y	4,740	0,255
WHW-475	4,750	160 @ 0,185	0,252	5	0,111	0,312	Y	4,995	0,257
WHW-500	5,000	170 @ 0,185	0,247	5	0,111	0,312	Y	5,260	0,252

¹ Add suffix "-S17" for stainless steel.
² See pages 134 –135 for How to Order.
³ 1 lb = 4,448 N
 1 psi = 0,0069 N/mm²
 1 inch = 25,4 mm

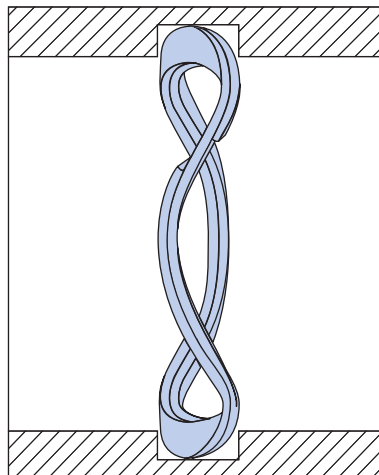

Stock Items available in carbon steel and 302 and 316 stainless steel.

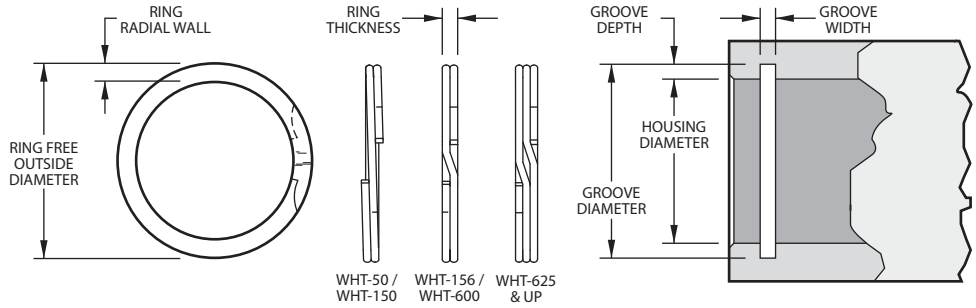
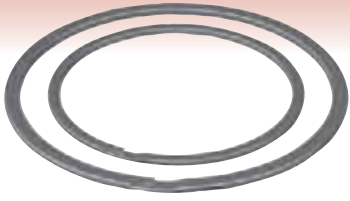

WHT-50 / WHT-150 WHT-156 / WHT-600 WHT-625 & UP

Product Dimensions All dimensions in inches unless otherwise specified.

Smalley Part Number ^{1,4}	Housing Diameter	Ring			Groove		Thrust Capacity		
		Outside Diameter	Radial Wall	Thickness	Diameter	Width	Groove Yield (lb) ²	Ring Shear (lb) ³	
WHT-50	0,500	0,529	0,045	0,035	0,524	±0,002	0,039	420	2530
WHT-51	0,512	0,541	0,045	0,035	0,536		0,039	430	2590
WHT-56	0,562	0,597	0,045	0,035	0,592		0,039	600	2840
WHT-62	0,625	0,665	0,045	0,035	0,659		0,039	750	3160
WHT-68	0,688	0,730	0,055	0,035	0,724		0,039	880	3480
WHT-75	0,750	0,796	0,055	0,035	0,790		0,039	1060	3790
WHT-77	0,777	0,825	0,065	0,042	0,819		0,046	1150	4720
WHT-81	0,812	0,864	0,065	0,042	0,857	±0,003	0,046	1320	4930
WHT-86	0,866	0,919	0,065	0,042	0,912		0,046	1410	5260
WHT-87	0,875	0,929	0,065	0,042	0,922		0,046	1480	5310
WHT-90	0,901	0,957	0,065	0,042	0,950		0,046	1590	5470
WHT-93	0,938	0,997	0,075	0,042	0,989		0,046	1720	5690
WHT-100	1,000	1,063	0,075	0,042	1,055	±0,002	0,046	1980	6070
WHT-102	1,023	1,087	0,075	0,042	1,079		0,046	2030	6210
WHT-106	1,062	1,129	0,078	0,050	1,120		0,056	2180	7010
WHT-112	1,125	1,195	0,078	0,050	1,185		0,056	2390	7420
WHT-118	1,188	1,260	0,088	0,050	1,250		0,056	2600	7840
WHT-125	1,250	1,330	0,093	0,050	1,320	±0,004	0,056	3090	8250
WHT-131	1,312	1,395	0,093	0,050	1,385		0,056	3430	8660
WHT-137	1,375	1,461	0,098	0,050	1,450	±0,004	0,056	3690	9070
WHT-143	1,438	1,526	0,103	0,050	1,515		0,056	3960	9490
WHT-145	1,456	1,546	0,108	0,050	1,535		0,056	4120	9610
WHT-150	1,500	1,591	0,108	0,050	1,580		0,056	4240	9900
WHT-156	1,562	1,659	0,113	0,062	1,647		0,068	4750	12780
WHT-162	1,625	1,727	0,113	0,062	1,715		0,068	5170	13290
WHT-165	1,653	1,757	0,118	0,062	1,745		0,068	5380	13520
WHT-168	1,688	1,793	0,118	0,062	1,780		0,068	5490	13810
WHT-175	1,750	1,858	0,118	0,062	1,845		0,068	5940	14320
WHT-181	1,812	1,923	0,123	0,062	1,910	±0,005	0,068	6280	14820
WHT-185	1,850	1,963	0,123	0,062	1,949		0,068	6540	15130
WHT-187	1,875	1,989	0,128	0,062	1,975		0,068	6630	15340
WHT-193	1,938	2,054	0,128	0,062	2,040		0,068	6990	15850
WHT-200	2,000	2,125	0,138	0,062	2,110	±0,003	0,068	7780	16360
WHT-206	2,062	2,190	0,141	0,078	2,175		0,086	8310	21220
WHT-212	2,125	2,255	0,141	0,078	2,240		0,086	8710	21870
WHT-218	2,188	2,321	0,141	0,078	2,305		0,086	9130	22520
WHT-225	2,250	2,386	0,141	0,078	2,370		0,086	9540	23160
WHT-231	2,312	2,457	0,188	0,078	2,440	±0,006	0,086	10460	23800
WHT-237	2,375	2,522	0,188	0,078	2,505		0,086	10910	24440
WHT-244	2,440	2,588	0,188	0,078	2,570		0,086	11210	25110
WHT-250	2,500	2,653	0,188	0,078	2,635		0,086	12020	25730
WHT-253	2,531	2,687	0,188	0,078	2,668		0,086	12350	26050
WHT-256	2,562	2,720	0,188	0,093	2,700		0,103	12500	29940
WHT-262	2,625	2,785	0,188	0,093	2,765		0,103	12990	30680

¹ Add suffix "-S02" for 302 stainless steel, "-S16" for 316 stainless steel.

² Based on a groove material yield strength of 45,000 psi and a safety factor of 2.

³ Based on a safety factor of 3.

⁴ See pages 134 - 135 for How to Order.

⁵ 1 lb = 4,448 N

1 psi = 0,0069 N/mm²

1 inch = 25,4 mm

Smalley Part Number ^{1,4}	Housing Diameter	Ring			Groove		Thrust Capacity	
		Outside Diameter	Radial Wall	Thickness	Diameter	Width	Groove Yield (lb) ²	Ring Shear (lb) ³
WHT-268	2,688	2,855	0,188	0,093	2,834	0,103	13870	31410
WHT-275	2,750	2,921	0,188	0,093	2,900	0,103	14580	32140
WHT-281	2,813	2,987	0,188	0,093	2,965	0,103	15110	32880
WHT-283	2,834	3,009	0,188	0,093	2,987	0,103	15430	33120
WHT-287	2,875	3,053	0,188	0,093	3,030	0,103	15850	33600
WHT-300	3,000	3,188	0,188	0,093	3,165	0,103	17600	35060
WHT-306	3,062	3,253	0,250	0,111	3,230	0,120	18180	42710
WHT-312	3,125	3,318	0,250	0,111	3,295	0,120	18780	43590
WHT-315	3,156	3,354	0,250	0,111	3,328	0,120	19190	44040
WHT-325	3,250	3,450	0,250	0,111	3,426	0,120	20220	45330
WHT-334	3,346	3,550	0,250	0,111	3,525	0,120	21290	46670
WHT-346	3,464	3,675	0,250	0,111	3,650	0,120	22770	48320
WHT-350	3,500	3,716	0,250	0,111	3,690	0,120	23500	48820
WHT-354	3,543	3,761	0,250	0,111	3,735	0,120	24040	49420
WHT-356	3,562	3,783	0,250	0,111	3,756	0,120	24420	49690
WHT-362	3,625	3,849	0,250	0,111	3,822	0,120	25370	50560
WHT-375	3,750	3,982	0,250	0,111	3,955	0,120	27300	52310
WHT-387	3,875	4,115	0,250	0,111	4,087	0,120	29030	54050
WHT-393	3,938	4,178	0,250	0,111	4,150	0,120	29510	54930
WHT-400	4,000	4,248	0,250	0,111	4,220	0,120	31100	55800
WHT-412	4,125	4,373	0,312	0,111	4,345	0,120	32070	57540
WHT-425	4,250	4,500	0,312	0,111	4,470	0,120	33050	59280
WHT-433	4,330	4,586	0,312	0,111	4,556	0,120	34590	60400
WHT-450	4,500	4,768	0,312	0,111	4,735	0,120	37530	62770
WHT-462	4,625	4,897	0,312	0,111	4,865	0,120	39230	64510
WHT-475	4,750	5,028	0,312	0,111	4,995	0,120	41300	66260
WHT-500	5,000	5,295	0,312	0,111	5,260	0,120	45950	69740
WHT-525	5,250	5,559	0,375	0,127	5,520	0,139	50100	83790
WHT-537	5,375	5,685	0,375	0,127	5,645	0,139	51290	85780
WHT-550	5,500	5,810	0,375	0,127	5,770	0,139	52480	87780
WHT-575	5,750	6,062	0,375	0,127	6,020	0,139	54870	91770
WHT-600	6,000	6,314	0,375	0,127	6,270	0,139	57260	95760

¹ Add suffix "-S02" for 302 stainless steel, "-S16" for 316 stainless steel.

² Based on a groove material yield strength of 45,000 psi and a safety factor of 2.

³ Based on a safety factor of 3.

⁴ See pages 134 –135 for How to Order.

⁵ 1 lb = 4,448 N

1 psi = 0,0069 N/mm²

1 inch = 25,4 mm

Rings listed below are three-turn construction.

Smalley Part Number ^{1,4}	Housing Diameter	Ring			Groove		Thrust Capacity	
		Outside Diameter	Radial Wall	Thickness	Diameter	Width	Groove Yield (lb) ²	Ring Shear (lb) ³
WHT-625	6,250	6,576	0,312	0,165	6,530	0,174	61850	129590
WHT-650	6,500	6,837	0,312	0,165	6,790	0,174	66620	134780
WHT-662	6,625	6,973	0,312	0,165	6,925	0,174	70240	137370
WHT-675	6,750	7,104	0,312	0,165	7,055	0,174	73000	139960
WHT-700	7,000	7,366	0,312	0,165	7,315	0,174	78180	145140
WHT-725	7,250	7,628	0,375	0,189	7,575	0,209	83530	172190
WHT-750	7,500	7,895	0,375	0,189	7,840	0,209	90120	178130
WHT-775	7,750	8,156	0,375	0,189	8,100	0,209	95870	184070
WHT-800	8,000	8,418	0,375	0,189	8,360	0,209	101790	190000
WHT-825	8,250	8,680	0,375	0,189	8,620	0,209	107880	195940
WHT-850	8,500	8,942	0,375	0,189	8,880	0,209	114160	201880
WHT-875	8,750	9,209	0,375	0,189	9,145	0,209	122460	207820
WHT-900	9,000	9,471	0,375	0,189	9,405	0,209	129140	213750
WHT-925	9,250	9,736	0,375	0,189	9,669	0,209	137310	219690
WHT-950	9,500	9,999	0,375	0,189	9,930	0,209	144380	225630
WHT-975	9,750	10,260	0,375	0,189	10,189	0,209	151620	231570
WHT-1000	10,000	10,552	0,375	0,189	10,450	0,209	159040	237500
WHT-1050	10,500	11,072	0,375	0,189	10,970	0,209	174420	249380

¹ Add suffix "-S02" for 302 stainless steel, "-S16" for 316 stainless steel.

² Based on a groove material yield strength of 45,000 psi and a safety factor of 2.

³ Based on a safety factor of 3.

⁴ See pages 134 –135 for How to Order.

⁵ 1 lb = 4,448 N

1 psi = 0,0069 N/mm²

1 inch = 25,4 mm

Stock Items available in carbon steel and 302 and 316 stainless steel.



AS3215, AS4299
MIL-DTL-27426/4

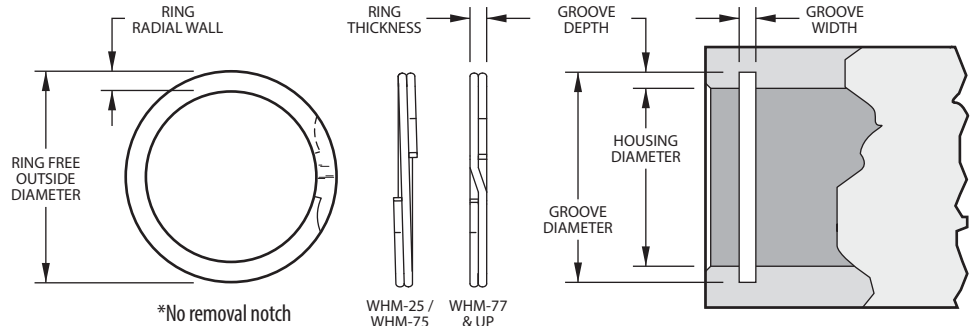

Product Dimensions All dimensions in inches unless otherwise specified.

Smalley Part Number ^{1,4}	Housing Diameter	Ring			Groove		Thrust Capacity	
		Outside Diameter	Radial Wall	Thickness	Diameter	Width	Groove Yield (lb) ²	Ring Shear (lb) ³
WHM-25*	0,250	0,270	0,020	0,015	0,268	0,020	159	561
WHM-31*	0,312	0,333	0,025	0,015	0,330	0,020	198	700
WHM-37*	0,375	0,400	0,030	0,025	0,397	0,029	292	1442
WHM-43	0,437	0,464	0,035	0,025	0,461	0,029	371	1680
WHM-50	0,500	0,538	0,045	0,035	0,530	0,039	530	2530
WHM-51	0,512	0,550	0,045	0,035	0,542	0,039	540	2590
WHM-56	0,562	0,605	0,055	0,035	0,596	0,039	680	2840
WHM-62	0,625	0,675	0,055	0,035	0,665	0,039	880	3160
WHM-68	0,688	0,743	0,065	0,035	0,732	0,039	1070	3480
WHM-75	0,750	0,807	0,065	0,035	0,796	0,039	1220	3790
WHM-77	0,777	0,836	0,075	0,042	0,825	0,046	1320	4720
WHM-81	0,812	0,873	0,075	0,042	0,862	0,046	1440	4930
WHM-86	0,866	0,931	0,075	0,042	0,920	0,046	1650	5260
WHM-87	0,875	0,943	0,085	0,042	0,931	0,046	1730	5310
WHM-90	0,901	0,972	0,085	0,042	0,959	0,046	1850	5470
WHM-93	0,938	1,013	0,085	0,042	1,000	0,046	2060	5690
WHM-100	1,000	1,080	0,085	0,042	1,066	0,046	2330	6070
WHM-102	1,023	1,105	0,085	0,042	1,091	0,046	2460	6210
WHM-106	1,062	1,138	0,103	0,050	1,130	0,056	2550	7010
WHM-112	1,125	1,205	0,103	0,050	1,197	0,056	2860	7420
WHM-118	1,188	1,271	0,103	0,050	1,262	0,056	3110	7840
WHM-125	1,250	1,339	0,103	0,050	1,330	0,056	3530	8250
WHM-131	1,312	1,406	0,118	0,050	1,396	0,056	3900	8660
WHM-137	1,375	1,471	0,118	0,050	1,461	0,056	4180	9070
WHM-143	1,439	1,539	0,118	0,050	1,528	0,056	4580	9490
WHM-145	1,456	1,559	0,118	0,050	1,548	0,056	4730	9610
WHM-150	1,500	1,605	0,118	0,050	1,594	0,056	4980	9900
WHM-156	1,562	1,675	0,128	0,062	1,658	0,068	5300	12780
WHM-162	1,625	1,742	0,128	0,062	1,725	0,068	5740	13290
WHM-165	1,653	1,772	0,128	0,062	1,755	0,068	5960	13520
WHM-168	1,688	1,810	0,128	0,062	1,792	0,068	6210	13810
WHM-175	1,750	1,876	0,128	0,062	1,858	0,068	6680	14320
WHM-181	1,812	1,940	0,128	0,062	1,922	0,068	7050	14820
WHM-185	1,850	1,981	0,158	0,062	1,962	0,068	7320	15130
WHM-187	1,875	2,008	0,158	0,062	1,989	0,068	7560	15340
WHM-193	1,938	2,075	0,158	0,062	2,056	0,068	8080	15850
WHM-200	2,000	2,142	0,158	0,062	2,122	0,068	8620	16360
WHM-206	2,062	2,201	0,168	0,078	2,186	0,086	9040	21220
WHM-212	2,125	2,267	0,168	0,078	2,251	0,086	9460	21870
WHM-218	2,188	2,334	0,168	0,078	2,318	0,086	10050	22520
WHM-225	2,250	2,399	0,168	0,078	2,382	0,086	10500	23160
WHM-231	2,312	2,467	0,200	0,078	2,450	0,086	11280	23800
WHM-237	2,375	2,535	0,200	0,078	2,517	0,086	11920	24440
WHM-244	2,440	2,602	0,200	0,078	2,584	0,086	12420	25110
WHM-250	2,500	2,667	0,200	0,078	2,648	0,086	13080	25730
WHM-253	2,531	2,700	0,200	0,078	2,681	0,086	13420	26050
WHM-256	2,562	2,733	0,225	0,093	2,714	0,103	13760	29940
WHM-262	2,625	2,801	0,225	0,093	2,781	0,103	14470	30680
WHM-268	2,688	2,868	0,225	0,093	2,848	0,103	15200	31410
WHM-275	2,750	2,934	0,225	0,093	2,914	0,103	15940	32140
WHM-281	2,813	3,001	0,225	0,093	2,980	0,103	16700	32880

¹ Add suffix "-S02" for 302 stainless steel, "-S16" for 316 stainless steel.

² Based on a groove material yield strength of 45,000 psi and a safety factor of 2.

³ Based on a safety factor of 3.

⁴ See pages 134 - 135 for How to Order.

⁵ 1 lb = 4,448 N

1 psi = 0,0069 N/mm²

1 inch = 25,4 mm

Smalley Part Number ^{1,4}	Housing Diameter	Ring			Groove		Thrust Capacity		
		Outside Diameter	Radial Wall	Thickness	Diameter	Width	Groove Yield (lb) ²	Ring Shear (lb) ³	
WHM-283	2,834	3,027	0,225	0,093	3,006	0,103	17230	33120	
WHM-287	2,875	3,072	+0,030/-0,000	0,225	0,093	3,051	0,103	17880	33600
WHM-300	3,000	3,204	0,225	0,093	3,182	0,103	18300	35060	
WHM-306	3,062	3,271	0,281	0,111	3,248	0,120	20130	42710	
WHM-312	3,125	3,338	0,281	0,111	3,315	0,120	20990	43590	
WHM-315	3,157	3,371	0,281	0,111	3,348	0,120	21420	44040	
WHM-325	3,250	3,470	0,281	0,111	3,446	0,120	22510	45330	
WHM-334	3,346	3,571	0,281	0,111	3,546	0,120	23650	46670	
WHM-347	3,464	3,701	0,281	0,111	3,675	0,120	25710	48320	
WHM-350	3,500	3,736	0,281	0,111	3,710	0,120	25980	48820	
WHM-354	3,543	3,781	0,281	0,111	3,755	0,120	26550	49420	
WHM-356	3,562	3,802	0,281	0,111	3,776	0,120	26940	49690	
WHM-362	3,625	3,868	0,281	0,111	3,841	0,120	27670	50560	
WHM-375	3,750	4,002	0,312	0,111	3,974	0,120	29690	52310	
WHM-387	3,875	4,136	0,312	0,111	4,107	0,120	31770	54050	
WHM-393	3,938	4,203	0,312	0,111	4,174	0,120	32850	54930	
WHM-400	4,000	4,270	0,312	0,111	4,240	0,120	33930	55800	
WHM-412	4,125	4,369	0,312	0,111	4,339	0,120	34990	57540	
WHM-425	4,250	4,501	0,312	0,111	4,470	0,120	36050	59280	
WHM-433	4,330	4,588	0,312	0,111	4,556	0,120	36730	60400	
WHM-450	4,500	4,768	0,312	0,111	4,735	0,120	38170	62770	
WHM-462	4,625	4,899	0,312	0,111	4,865	0,120	39230	64510	
WHM-475	4,750	5,030	0,312	0,111	4,995	0,120	41300	66260	
WHM-500	5,000	5,297	0,312	0,111	5,260	0,120	45950	69740	
WHM-525	5,250	5,559	0,350	0,127	5,520	0,139	50100	83790	
WHM-537	5,375	5,690	0,350	0,127	5,650	0,139	51290	85780	
WHM-550	5,500	5,810	0,350	0,127	5,770	0,139	52480	87780	
WHM-575	5,750	6,062	0,350	0,127	6,020	0,139	54870	91770	
WHM-600	6,000	6,314	0,350	0,127	6,270	0,139	57260	95760	
WHM-625	6,250	6,576	0,380	0,156	6,530	0,174	61850	122520	
WHM-650	6,500	6,838	0,380	0,156	6,790	0,174	66620	127420	
WHM-662	6,625	6,974	0,380	0,156	6,925	0,174	70240	129870	
WHM-675	6,750	7,105	0,380	0,156	7,055	0,174	73000	132320	
WHM-700	7,000	7,366	0,380	0,156	7,315	0,174	78180	137230	
WHM-725	7,250	7,628	0,418	0,187	7,575	0,209	83530	170370	
WHM-750	7,500	7,895	0,418	0,187	7,840	0,209	90120	176240	
WHM-775	7,750	8,157	0,418	0,187	8,100	0,209	95870	182120	
WHM-800	8,000	8,419	0,418	0,187	8,360	0,209	101790	187990	
WHM-825	8,250	8,680	0,437	0,187	8,620	0,209	107880	193870	
WHM-850	8,500	8,942	0,437	0,187	8,880	0,209	114160	199740	
WHM-875	8,750	9,209	0,437	0,187	9,145	0,209	122460	205620	
WHM-900	9,000	9,471	0,437	0,187	9,405	0,209	129140	211490	
WHM-925	9,250	9,737	0,437	0,187	9,669	0,209	137310	217370	
WHM-950	9,500	10,000	0,500	0,187	9,930	0,209	144380	223240	
WHM-975	9,750	10,260	0,500	0,187	10,189	0,209	150620	229120	
WHM-1000	10,000	10,523	0,500	0,187	10,450	0,209	159040	234990	
WHM-1025	10,250	10,786	0,500	0,187	10,711	0,209	167370	240870	
WHM-1050	10,500	11,047	0,500	0,187	10,970	0,209	174420	246740	
WHM-1075	10,750	11,313	0,500	0,187	11,234	0,209	183890	252620	
WHM-1100	11,000	11,575	0,500	0,187	11,495	0,209	192830	258490	
WHM-1125	11,250	11,838	0,500	0,187	11,756	0,209	201190	264370	
WHM-1150	11,500	12,102	0,562	0,187	12,018	0,209	210540	270240	
WHM-1175	11,750	12,365	0,562	0,187	12,279	0,209	220100	276120	
WHM-1200	12,000	12,628	0,562	0,187	12,540	0,209	229020	281990	
WHM-1225	12,250	12,891	0,562	0,187	12,801	0,209	238990	287860	
WHM-1250	12,500	13,154	0,562	0,187	13,063	0,209	249170	293740	
WHM-1275	12,750	13,417	0,562	0,187	13,324	0,209	258660	299610	
WHM-1300	13,000	13,680	0,662	0,187	13,585	0,209	269240	305490	
WHM-1325	13,250	13,943	0,662	0,187	13,846	0,209	279100	311360	
WHM-1350	13,500	14,207	0,662	0,187	14,108	0,209	290100	317240	
WHM-1375	13,750	14,470	0,662	0,187	14,369	0,209	301300	323110	
WHM-1400	14,000	14,732	0,662	0,187	14,630	0,209	311730	328990	
WHM-1425	14,250	14,995	0,662	0,187	14,891	0,209	323340	334860	
WHM-1450	14,500	15,259	0,750	0,187	15,153	0,209	335160	340740	
WHM-1475	14,750	15,522	0,750	0,187	15,414	0,209	346150	346610	
WHM-1500	15,000	15,785	0,750	0,187	15,675	0,209	358380	352490	

¹ Add suffix "-S02" for 302 stainless steel, "-S16" for 316 stainless steel.

² Based on a groove material yield strength of 45,000 psi and a safety factor of 2.

³ Based on a safety factor of 3.

⁴ See pages 134 – 135 for How to Order.

⁵ 1 lb = 4,448 N

1 psi = 0,0069 N/mm²

1 inch = 25,4 mm

Stock Items available in carbon steel and 302 stainless steel.

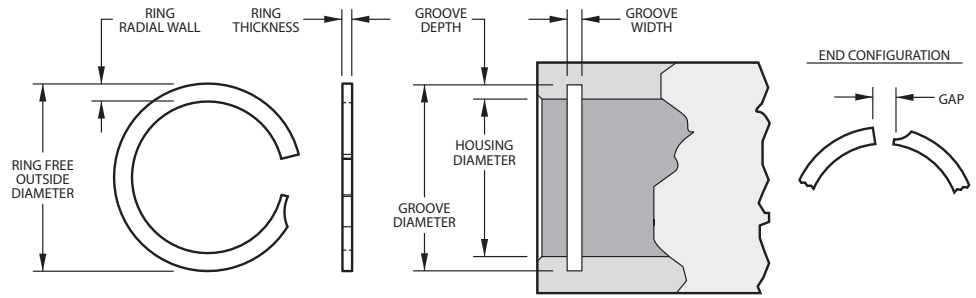

Product Dimensions All dimensions in inches unless otherwise specified.

Smalley Part Number ^{1,4}	Housing Diameter	Ring			Groove		Thrust Capacity	
		Outside Diameter	Radial Wall	Thickness	Diameter	Width	Groove Yield (lb) ²	Ring Shear (lb) ³
FHE-0050	0,500	0,529	0,055	0,037	0,524	0,043	424	2325
FHE-0056	0,562	0,591	0,055	0,037	0,586	0,043	477	2613
FHE-0062	0,625	0,665	0,065	0,037	0,657	0,043	707	2906
FHE-0068	0,687	0,726	0,065	0,037	0,719	0,043	777	3194
FHE-0075	0,750	0,797	0,075	0,037	0,790	0,043	1060	3487
FHE-0081	0,812	0,860	0,075	0,037	0,852	0,043	1148	3775
FHE-0087	0,875	0,924	0,075	0,037	0,915	0,043	1237	4068
FHE-0093	0,937	1,000	0,085	0,045	0,985	0,051	1590	5334
FHE-0100	1,000	1,058	0,085	0,045	1,048	0,051	1696	5693
FHE-0106	1,062	1,121	0,094	0,045	1,110	0,051	1802	6045
FHE-0112	1,125	1,192	0,094	0,045	1,181	0,051	2227	6404
FHE-0118	1,187	1,252	0,094	0,045	1,243	0,051	2349	6757
FHE-0125	1,250	1,336	0,094	0,045	1,316	0,051	2916	7116
FHE-0131	1,312	1,391	0,094	0,045	1,378	0,051	3060	7469
FHE-0137	1,375	1,470	0,128	0,057	1,453	0,063	3791	9307
FHE-0143	1,437	1,529	0,128	0,057	1,515	0,063	3961	9727
FHE-0150	1,500	1,592	0,128	0,057	1,578	0,063	4135	10153
FHE-0156	1,562	1,687	0,158	0,067	1,666	0,073	5741	12400
FHE-0162	1,625	1,746	0,158	0,067	1,729	0,073	5973	12901
FHE-0168	1,687	1,808	0,158	0,067	1,791	0,073	6201	13393
FHE-0175	1,750	1,885	0,158	0,067	1,862	0,073	6927	13893
FHE-0181	1,812	1,942	0,158	0,067	1,924	0,073	7173	14385
FHE-0187	1,875	2,007	0,158	0,067	1,987	0,073	7422	14885
FHE-0193	1,937	2,074	0,200	0,076	2,055	0,085	8078	16649
FHE-0200	2,000	2,143	0,200	0,076	2,118	0,085	8341	17191
FHE-0206	2,062	2,200	0,200	0,076	2,180	0,085	8599	17724
FHE-0212	2,125	2,264	0,200	0,076	2,243	0,085	8862	18265
FHE-0218	2,187	2,327	0,200	0,076	2,305	0,085	9121	18798
FHE-0225	2,250	2,389	0,200	0,076	2,368	0,085	9384	19340
FHE-0231	2,312	2,453	0,200	0,076	2,430	0,085	9642	19873
FHE-0237	2,375	2,517	0,200	0,076	2,493	0,085	9905	20414
FHE-0243	2,437	2,582	0,200	0,076	2,555	0,085	10163	20947
FHE-0250	2,500	2,643	0,200	0,076	2,618	0,085	10426	21488
FHE-0256	2,562	2,705	0,200	0,095	2,680	0,104	10685	26225
FHE-0262	2,625	2,777	0,200	0,095	2,743	0,104	10947	26870
FHE-0268	2,687	2,828	0,200	0,095	2,805	0,104	11206	27504
FHE-0275	2,750	2,899	0,200	0,095	2,868	0,104	11469	28149
FHE-0281	2,812	2,958	0,200	0,095	2,930	0,104	11727	28784
FHE-0287	2,875	3,022	0,200	0,095	2,993	0,104	11990	29429
FHE-0293	2,937	3,084	0,200	0,095	3,055	0,104	12249	30063
FHE-0300	3,000	3,145	0,200	0,095	3,118	0,104	12511	30708
FHE-0306	3,062	3,218	0,200	0,095	3,184	0,104	13203	31343
FHE-0312	3,125	3,294	0,237	0,095	3,263	0,104	15242	31988
FHE-0318	3,187	3,357	0,237	0,095	3,325	0,104	15544	32622
FHE-0325	3,250	3,420	0,237	0,095	3,388	0,104	15851	33267

¹ Add suffix "-S02" for 302 stainless steel.

² Based on a groove material yield strength of 45,000 psi and a safety factor of 2.

³ Based on a safety factor of 3.

⁴ See pages 134 - 135 for How to Order.

⁵ 1 lb = 4,448 N

1 psi = 0,0069 N/mm²

1 inch = 25,4 mm

Smalley Part Number ^{1,4}	Housing Diameter	Ring			Groove		Thrust Capacity	
		Outside Diameter	Radial Wall	Thickness	Diameter	Width	Groove Yield (lb) ²	Ring Shear (lb) ³
FHE-0331	3,312	3,483	0,248	0,115	3,450	0,124	16154	38952
FHE-0337	3,375	3,547	0,248	0,115	3,513	0,124	16461	39693
FHE-0343	3,437	3,609	0,248	0,115	3,575	0,124	16763	40422
FHE-0350	3,500	3,673	0,248	0,115	3,638	0,124	17071	41163
FHE-0356	3,562	3,728	0,248	0,115	3,700	0,124	17373	41892
FHE-0362	3,625	3,799	0,248	0,115	3,763	0,124	17680	42633
FHE-0368	3,687	3,862	0,248	0,115	3,825	0,124	17983	43362
FHE-0375	3,750	3,922	0,248	0,115	3,888	0,124	18290	44103
FHE-0381	3,812	3,988	0,248	0,115	3,950	0,124	18592	44832
FHE-0387	3,875	4,044	0,248	0,115	4,013	0,124	18900	45573
FHE-0393	3,937	4,114	0,248	0,115	4,075	0,124	19202	46302
FHE-0400	4,000	4,223	0,265	0,153	4,158	0,163	22337	60283
FHE-0412	4,125	4,329	0,265	0,153	4,283	0,163	23035	62166
FHE-0425	4,250	4,452	0,265	0,153	4,408	0,163	23733	64050
FHE-0437	4,375	4,576	0,265	0,153	4,533	0,163	24431	65934
FHE-0450	4,500	4,703	0,265	0,153	4,658	0,163	25129	67818
FHE-0462	4,625	4,829	0,265	0,153	4,783	0,163	25827	69702
FHE-0475	4,750	4,945	0,265	0,153	4,908	0,163	26525	71585
FHE-0487	4,875	5,082	0,265	0,153	5,033	0,163	27223	73469
FHE-0500	5,000	5,207	0,265	0,153	5,158	0,163	27921	75353
FHE-0525	5,250	5,460	0,265	0,153	5,408	0,163	29317	79121
FHE-0550	5,500	5,719	0,265	0,153	5,658	0,163	30713	82888
FHE-0575	5,750	5,965	0,265	0,153	5,908	0,163	32109	86656
FHE-0600	6,000	6,256	0,316	0,153	6,196	0,163	41563	90424
FHE-0625	6,250	6,508	0,316	0,153	6,446	0,163	43295	94191
FHE-0650	6,500	6,760	0,316	0,153	6,696	0,163	45027	97959
FHE-0675	6,750	7,013	0,316	0,153	6,946	0,163	46759	101727
FHE-0700	7,000	7,266	0,316	0,153	7,196	0,163	48490	105494
FHE-0725	7,250	7,541	0,316	0,153	7,446	0,163	50222	109262
FHE-0750	7,500	7,762	0,316	0,153	7,696	0,163	51954	113030
FHE-0775	7,750	8,023	0,316	0,153	7,946	0,163	53686	116797
FHE-0800	8,000	8,276	0,316	0,153	8,196	0,163	55418	120565
FHE-0825	8,250	8,580	0,373	0,192	8,486	0,203	68813	147399
FHE-0850	8,500	8,821	0,373	0,192	8,736	0,203	70898	151866
FHE-0875	8,750	9,073	0,373	0,192	8,986	0,203	72983	156332
FHE-0900	9,000	9,326	0,373	0,192	9,236	0,203	75068	160799
FHE-0925	9,250	9,580	0,373	0,192	9,486	0,203	77154	165265
FHE-0950	9,500	9,831	0,373	0,192	9,736	0,203	79239	169732
FHE-0975	9,750	10,083	0,373	0,192	9,986	0,203	81324	174199
FHE-1000	10,000	10,414	0,435	0,192	10,314	0,203	110977	178665
FHE-1025	10,250	10,660	0,435	0,192	10,564	0,203	113751	183132
FHE-1050	10,500	10,919	0,435	0,192	10,814	0,203	116526	187599
FHE-1075	10,750	11,171	0,435	0,192	11,064	0,203	119300	192065
FHE-1100	11,000	11,440	0,435	0,192	11,314	0,203	122074	196532

¹ Add suffix "-S02" for 302 stainless steel.

² Based on a groove material yield strength of 45,000 psi and a safety factor of 2.

³ Based on a safety factor of 3.

⁴ See pages 134 – 135 for How to Order.

⁵ 1 lb = 4,448 N

1 psi = 0,0069 N/mm²

1 inch = 25,4 mm

Stock Items available in carbon steel and 302 stainless steel.

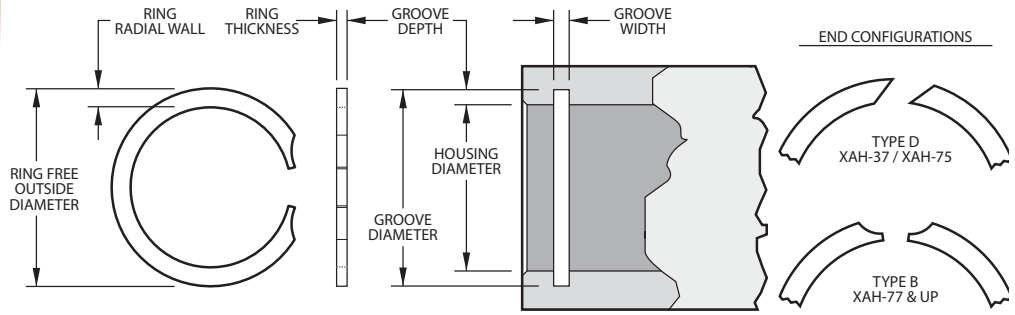

Product Dimensions All dimensions in inches unless otherwise specified.

Smalley Part Number ^{1,4}	Housing Diameter	Ring			Groove		Thrust Capacity		
		Outside Diameter	Radial Wall	Thickness	Diameter	Width	Groove Yield (lb) ²	Ring Shear (lb) ³	
XAH-37	0,375	0,400	±0,020/-0,000	0,035	0,025	0,395	0,028	265	1174
XAH-43	0,438	0,467	±0,020/-0,000	0,035	0,025	0,462	0,028	372	1371
XAH-50	0,500	0,530	±0,025/-0,000	0,040	0,035	0,524	0,039	424	2073
XAH-51	0,512	0,542	±0,025/-0,000	0,040	0,035	0,536	0,039	434	2123
XAH-56	0,562	0,600	±0,025/-0,000	0,048	0,035	0,590	0,039	556	2331
XAH-62	0,625	0,670	±0,025/-0,000	0,048	0,035	0,657	0,039	707	2592
XAH-68	0,688	0,733	±0,025/-0,000	0,048	0,035	0,720	0,039	778	2853
XAH-75	0,750	0,799	±0,025/-0,000	0,048	0,035	0,786	0,039	954	3110
XAH-77	0,777	0,827	±0,025/-0,000	0,062	0,042	0,813	0,046	989	3906
XAH-81	0,812	0,867	±0,031/-0,000	0,062	±0,003	0,852	0,046	1148	4082
XAH-87	0,875	0,934	±0,031/-0,000	0,062	±0,003	0,919	0,046	1361	4398
XAH-90	0,901	0,961	±0,031/-0,000	0,078	±0,003	0,945	0,046	1401	4529
XAH-93	0,938	1,003	±0,031/-0,000	0,078	±0,003	0,986	0,046	1591	4715
XAH-100	1,000	1,070	±0,031/-0,000	0,078	±0,003	1,052	0,046	1696	5027
XAH-102	1,023	1,094	±0,031/-0,000	0,093	±0,002	1,075	0,046	1880	5142
XAH-106	1,062	1,134	±0,031/-0,000	0,093	±0,002	1,114	0,056	1952	6272
XAH-112	1,125	1,202	±0,031/-0,000	0,093	±0,002	1,181	0,056	2227	6644
XAH-118	1,188	1,270	±0,031/-0,000	0,093	±0,002	1,248	0,056	2519	7017
XAH-125	1,250	1,337	±0,031/-0,000	0,109	±0,002	1,314	0,056	2827	7383
XAH-131	1,312	1,404	±0,031/-0,000	0,109	±0,002	1,380	0,056	3153	7749
XAH-137	1,375	1,472	±0,031/-0,000	0,109	±0,002	1,447	0,056	3499	8121
XAH-143	1,438	1,535	±0,031/-0,000	0,125	±0,002	1,510	0,056	3659	8493
XAH-145	1,456	1,557	±0,031/-0,000	0,125	±0,002	1,532	0,056	3911	8599
XAH-150	1,500	1,607	±0,031/-0,000	0,125	±0,002	1,576	0,056	4029	8859
XAH-156	1,562	1,668	±0,031/-0,000	0,125	±0,002	1,642	0,068	4416	11002
XAH-162	1,625	1,736	±0,031/-0,000	0,141	±0,002	1,709	0,068	4824	11446
XAH-165	1,653	1,765	±0,031/-0,000	0,141	±0,002	1,737	0,068	4907	11643
XAH-168	1,688	1,804	±0,031/-0,000	0,156	±0,002	1,776	0,068	5250	11889
XAH-175	1,750	1,870	±0,031/-0,000	0,156	±0,002	1,842	0,068	5690	12326
XAH-181	1,812	1,933	±0,031/-0,000	0,156	±0,002	1,904	0,068	5892	12763
XAH-185	1,850	1,975	±0,031/-0,000	0,156	±0,002	1,946	0,068	6277	13030
XAH-187	1,875	2,000	±0,031/-0,000	0,156	±0,002	1,971	0,068	6362	13206
XAH-193	1,938	2,068	±0,031/-0,000	0,156	±0,002	2,038	0,068	6849	13650
XAH-196	1,968	2,098	±0,031/-0,000	0,156	±0,002	2,068	0,068	6955	13862
XAH-200	2,000	2,131	±0,031/-0,000	0,156	±0,002	2,100	0,068	7069	14087
XAH-206	2,062	2,197	±0,031/-0,000	0,156	±0,002	2,166	0,086	7579	17491
XAH-212	2,125	2,260	±0,031/-0,000	0,156	±0,002	2,229	0,086	7811	18025
XAH-218	2,188	2,331	±0,031/-0,000	0,171	±0,002	2,296	0,086	8352	18559
XAH-225	2,250	2,393	±0,031/-0,000	0,171	±0,002	2,358	0,086	8588	19085
XAH-231	2,312	2,459	±0,031/-0,000	0,171	±0,002	2,424	0,086	9152	19611
XAH-237	2,375	2,523	±0,031/-0,000	0,171	±0,002	2,487	0,086	9401	20145
XAH-244	2,440	2,592	±0,031/-0,000	0,187	±0,002	2,556	0,086	10003	20697
XAH-250	2,500	2,653	±0,031/-0,000	0,187	±0,002	2,616	0,086	10249	21206
XAH-253	2,531	2,688	±0,031/-0,000	0,187	±0,002	2,651	0,086	10734	21469
XAH-256	2,562	2,726	±0,031/-0,000	0,187	±0,002	2,686	0,103	11228	26078
XAH-262	2,625	2,790	±0,031/-0,000	0,187	±0,002	2,750	0,103	11504	26719
XAH-268	2,688	2,856	±0,031/-0,000	0,187	±0,002	2,816	0,103	11780	27361
XAH-271	2,717	2,882	±0,031/-0,000	0,187	±0,002	2,842	0,103	12291	27656

¹ Add suffix "-S02" for 302 stainless steel.

² Based on a groove material yield strength of 45,000 psi and a safety factor of 2.

³ Based on a safety factor of 3.

⁴ See pages 134 –135 for How to Order.

⁵ 1 lb = 4,448 N

1 psi = 0,0069 N/mm²

1 inch = 25,4 mm

Smalley Part Number ^{1,4}	Housing Diameter	Ring			Groove		Thrust Capacity	
		Outside Diameter	Radial Wall	Thickness	Diameter	Width	Groove Yield (lb) ²	Ring Shear (lb) ³
XAH-275	2,750	2,918	0,187	0,093	2,878	0,103	12441	27992
XAH-281	2,813	2,985	0,187	0,093	2,945	0,103	13123	28633
XAH-283	2,834	3,006	0,187	0,093	2,966	0,103	13221	28847
XAH-287	2,875	3,056	0,187	0,093	3,011	0,103	13819	29264
XAH-300	3,000	3,181	0,187	0,093	3,136	0,103	14420	30536
XAH-306	3,062	3,247	0,218	0,109	3,202	0,120	15151	35009
XAH-312	3,125	3,311	0,218	0,109	3,265	0,120	15463	35729
XAH-315	3,156	3,342	0,218	0,109	3,296	0,120	15616	36084
XAH-325	3,250	3,442	0,218	0,109	3,394	0,120	16540	37158
XAH-334	3,346	3,539	0,218	0,109	3,490	0,120	17029	38256
XAH-346	3,469	3,663	0,218	0,109	3,613	0,120	17655	39662
XAH-350	3,500	3,700	0,250	0,109	3,648	0,120	18308	40017
XAH-354	3,543	3,745	0,250	0,109	3,691	0,120	18533	40508
XAH-356	3,562	3,766	0,250	0,109	3,710	0,120	18632	40725
XAH-362	3,625	3,831	0,250	0,109	3,773	0,120	18961	41446
XAH-375	3,750	3,962	0,250	0,109	3,902	0,120	20145	42875
XAH-387	3,875	4,089	0,250	0,109	4,027	0,120	20817	44304
XAH-393	3,938	4,156	0,250	0,109	4,094	0,120	21712	45024
XAH-400	4,000	4,221	0,250	0,109	4,156	0,120	22054	45733
XAH-412	4,125	4,355	0,250	0,109	4,285	0,120	23326	47162
XAH-425	4,250	4,485	0,250	0,109	4,410	0,120	24033	48592
XAH-433	4,330	4,565	0,250	0,109	4,490	0,120	24486	49506
XAH-443	4,436	4,670	0,250	0,109	4,596	0,120	25085	50718
XAH-450	4,500	4,744	0,250	0,109	4,664	0,120	26083	51450
XAH-462	4,625	4,875	0,250	0,109	4,795	0,120	27788	52879
XAH-475	4,750	5,011	0,281	0,109	4,926	0,120	29547	54308
XAH-500	5,000	5,265	0,281	0,109	5,180	0,120	31809	57167
XAH-525	5,250	5,530	0,312	0,125	5,435	0,139	34141	65732
XAH-537	5,375	5,660	0,312	0,125	5,565	0,139	36094	67297
XAH-550	5,500	5,796	0,312	0,125	5,696	0,139	38100	68862
XAH-575	5,750	6,050	0,312	0,125	5,950	0,139	40644	71992
XAH-600	6,000	6,309	0,312	0,125	6,204	0,139	43260	75122
XAH-625	6,250	6,568	0,343	0,156	6,458	0,174	45946	94130
XAH-650	6,500	6,832	0,343	0,156	6,712	0,174	48703	97895
XAH-662	6,625	6,975	0,343	0,156	6,845	0,174	51512	99778
XAH-675	6,750	7,100	0,343	0,156	6,970	0,174	52484	101660
XAH-700	7,000	7,350	0,343	0,156	7,220	0,174	54428	105426
XAH-725	7,250	7,630	0,375	0,187	7,500	0,209	64059	123654
XAH-750	7,500	7,890	0,375	0,187	7,750	0,209	66268	127918
XAH-800	8,000	8,400	0,375	0,187	8,250	0,209	70686	136446
XAH-825	8,250	8,665	0,437	0,187	8,540	0,209	84558	141478
XAH-850	8,500	8,915	0,437	0,187	8,790	0,209	87120	145766
XAH-875	8,750	9,205	0,500	0,187	9,080	0,209	102053	150053
XAH-900	9,000	9,455	0,500	0,187	9,330	0,209	104968	154340
XAH-905	9,055	9,509	0,500	0,187	9,384	0,209	105610	155283
XAH-950	9,500	9,955	0,500	0,187	9,830	0,209	110800	162915
XAH-984	9,840	10,295	0,500	0,187	10,170	0,209	114766	168745
XAH-1000	10,000	10,455	0,500	0,187	10,330	0,209	116632	171489

¹ Add suffix "-S02" for 302 stainless steel.

² Based on a groove material yield strength of 45,000 psi and a safety factor of 2.

³ Based on a safety factor of 3.

⁴ See pages 134 – 135 for How to Order.

⁵ 1 lb = 4,448 N

1 psi = 0,0069 N/mm²

1 inch = 25,4 mm

Stock Items available in carbon steel and 302 stainless steel.

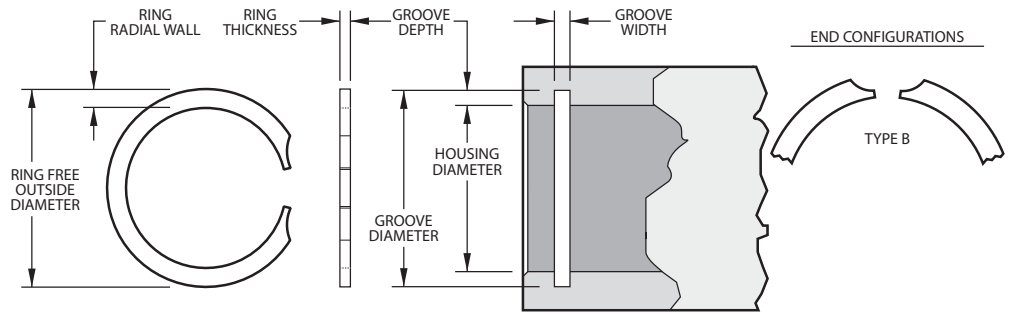

Product Dimensions All dimensions in inches unless otherwise specified.

Smalley Part Number ^{1,4}	Housing Diameter	Ring			Groove		Thrust Capacity	
		Outside Diameter	Radial Wall	Thickness	Diameter	Width	Groove Yield (lb) ²	Ring Shear (lb) ³
XDH-112	1,125	1,196	0,093	0,042	1,181	0,046	2227	5655
XDH-125	1,250	1,330	0,093	0,042	1,310	0,046	2651	6283
XDH-137	1,375	1,460	0,093	0,042	1,435	0,046	2916	6912
XDH-150	1,500	1,600	0,125	0,042	1,580	0,046	4241	7540
XDH-162	1,625	1,725	0,125	0,042	1,705	0,046	4595	8168
XDH-175	1,750	1,855	0,125	0,042	1,830	0,046	4948	8796
XDH-187	1,875	1,990	0,156	0,042	1,965	0,046	5964	9425
XDH-200	2,000	2,115	0,156	0,042	2,090	0,046	6362	10053
XDH-206	2,062	2,177	0,156	0,042	2,152	0,046	6559	10365
XDH-218	2,187	2,302	0,156	0,042	2,277	0,046	6957	10993
XDH-231	2,312	2,432	0,156	0,042	2,402	0,046	7354	11621
XDH-243	2,437	2,557	0,156	0,042	2,527	0,046	7752	12250
XDH-256	2,562	2,682	0,156	0,042	2,652	0,046	8149	12878
XDH-300	3,000	3,154	0,187	0,062	3,124	0,068	13148	21130
XDH-325	3,250	3,404	0,187	0,062	3,374	0,068	14243	22891
XDH-350	3,500	3,654	0,187	0,062	3,624	0,068	15339	24652
XDH-375	3,750	3,904	0,187	0,062	3,874	0,068	16434	26413
XDH-400	4,000	4,155	0,187	0,062	4,125	0,068	17671	28174
XDH-425	4,250	4,429	0,218	0,078	4,394	0,086	21630	36050
XDH-450	4,500	4,679	0,218	0,078	4,644	0,086	22902	38170
XDH-475	4,750	4,929	0,218	0,078	4,894	0,086	24175	40291
XDH-500	5,000	5,184	0,218	0,078	5,144	0,086	25447	42412
XDH-525	5,250	5,434	0,218	0,078	5,394	0,086	26719	44532
XDH-575	5,750	5,934	0,218	0,078	5,894	0,086	29264	48773
XDH-600	6,000	6,220	0,250	0,093	6,160	0,103	33929	61073
XDH-650	6,500	6,730	0,250	0,093	6,660	0,103	36757	66162
XDH-700	7,000	7,240	0,250	0,093	7,160	0,103	39584	71251
XDH-725	7,250	7,500	0,250	0,093	7,410	0,103	40998	73796
XDH-750	7,500	7,760	0,250	0,093	7,660	0,103	42412	76341
XDH-800	8,000	8,285	0,250	0,093	8,160	0,103	45239	81430

¹ Add suffix "-S02" for 302 stainless steel.

² Based on a groove material yield strength of 45,000 psi and a safety factor of 2.

³ Based on a safety factor of 3.

⁴ See pages 134 –135 for How to Order.

⁵ 1 lb = 4,448 N

1 psi = 0,0069 N/mm²

1 inch = 25,4 mm

ID/OD Retaining Ring Lock

Spirolox Retaining Rings can operate in an internal and an external groove simultaneously. Spiral type retaining rings have many benefits for the ID/OD Lock, these benefits include concealed fastening, no required assembly tooling and a 360° rotational capacity. With a Spirolox Retaining Ring, the application is tamper-proof and aesthetically pleasing.

In this featured application, the retaining ring is initially installed in the housing groove. When the mating component in the assembly is added, the retaining ring compresses into the groove. The groove is deep enough for the rings radial wall to fit into as the component slides into position. Finally, when the grooves meet, the retaining ring snaps into the shaft groove (groove depth equals 1/2 the retaining rings radial wall) while still in the housing groove.

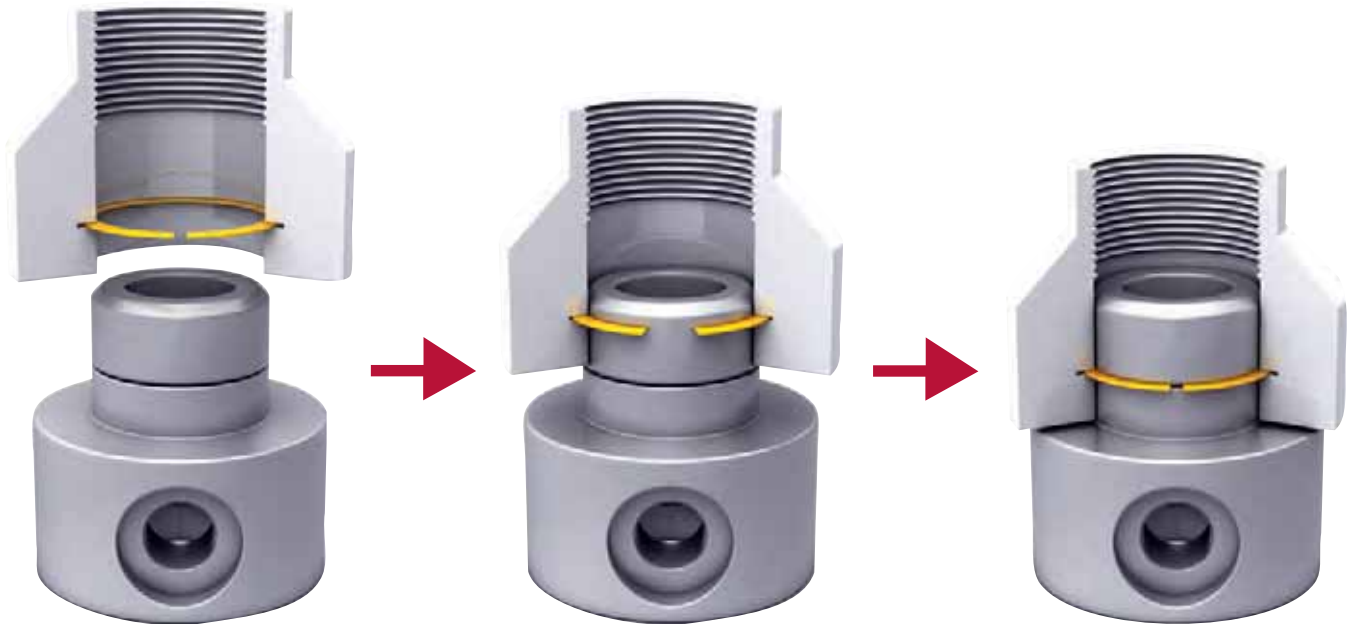

In the pneumatic fitting and hose connector applications depicted below, a 2-Turn retaining ring without removal notches or an offset, creates an ID/OD lock, permitting the 360° rotation of the nut.

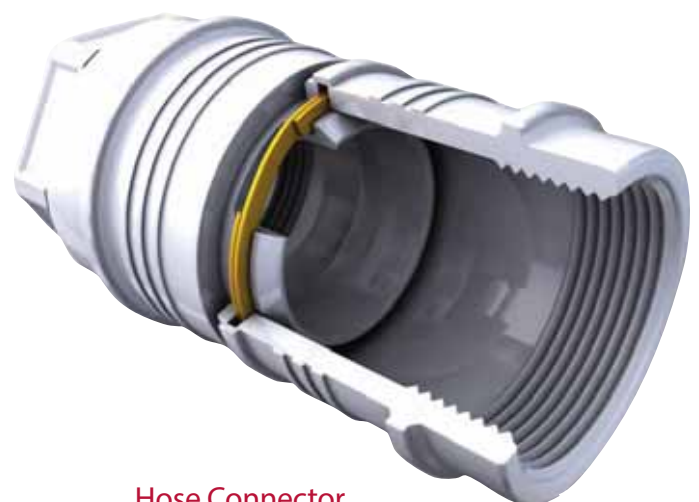

Stock Items available in carbon steel and 302 and 316 stainless steel.

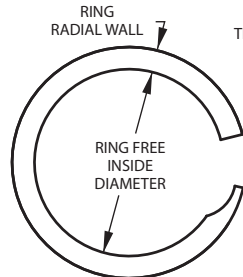
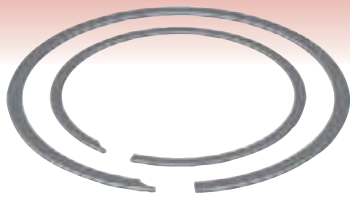

*No removal notch

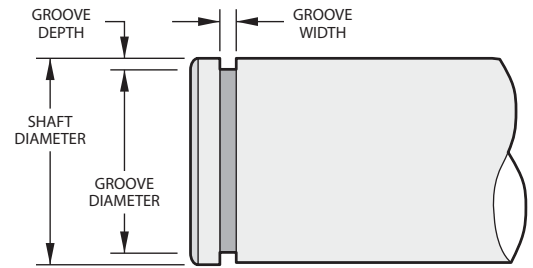
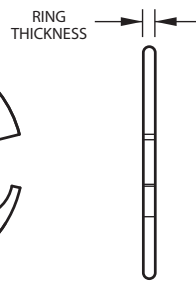

Product Dimensions All dimensions in millimeters unless otherwise specified.

Smalley Part Number ^{1,4}	Shaft Diameter	Ring			Groove		Thrust Capacity	
		Inside Diameter	Radial Wall	Thickness	Diameter	Width	Groove Yield (N) ²	Ring Shear (N) ³
VSM-6*	6,00	5,65	0,51	0,30	5,70	0,38	439	1988
VSM-7*	7,00	6,58	0,51	0,30	6,64	0,38	614	2234
VSM-8*	8,00	7,52	0,64	0,38	7,60	0,46	780	3183
VSM-9*	9,00	8,42	0,76	0,38	8,50	0,46	1114	3580
VSM-10*	10,00	9,32	0,89	0,38	9,40	0,46	1462	3978
VSM-11	11,00	10,32	0,89	0,38	10,40	0,46	1608	4376
VSM-12	12,00	11,22	1,14	0,46	11,34	0,56	1930	5779
VSM-13	13,00	12,15	1,14	0,46	12,28	0,56	2281	6261
VSM-14	14,00	13,15	1,14	0,46	13,28	0,56	2456	6742
VSM-15	15,00	14,14	1,14	0,46	14,28	0,56	2632	7224
VSM-16	16,00	15,13	1,14	0,46	15,28	0,56	2807	7705
VSM-17	17,00	16,13	1,14	0,46	16,28	0,56	2983	8187
VSM-18	18,00	17,12	1,14	0,46	17,28	0,56	3158	8669
VSM-19	19,00	18,11	1,14	0,46	18,28	0,56	3334	9150
VSM-20	20,00	19,10	1,14	0,46	19,28	0,56	3509	9632
VSM-21	21,00	19,74	1,65	0,53	19,94	0,66	5424	11652
VSM-22	22,00	20,73	1,65	0,53	20,94	0,66	5683	12207
VSM-24	24,00	22,72	1,65	0,53	22,94	0,66	6199	13317
VSM-25	25,00	23,71	1,65	0,53	23,94	0,66	6458	13872
VSM-26	26,00	24,63	2,24	0,64	24,88	0,79	7096	15138
VSM-28	28,00	26,62	2,24	0,64	26,88	0,79	7642	16303
VSM-29	29,00	27,61	2,24	0,64	27,88	0,79	7915	16885
VSM-30	30,00	28,59	2,24	0,64	28,88	0,79	8188	17467
VSM-32	32,00	30,57	2,24	0,64	30,88	0,79	8734	18632
VSM-34	34,00	32,56	2,24	0,64	32,88	0,79	9279	19796
VSM-35	35,00	33,55	2,24	0,64	33,88	0,79	9552	20378
VSM-36	36,00	34,54	2,24	0,64	34,88	0,79	9825	20960
VSM-38	38,00	36,52	2,24	0,64	36,88	0,79	10371	22125
VSM-40	40,00	38,09	3,00	0,79	38,52	0,99	14426	28748
VSM-42	42,00	40,07	3,00	0,79	40,52	0,99	15147	30185
VSM-45	45,00	43,04	3,00	0,79	43,52	0,99	16229	32341
VSM-48	48,00	46,01	3,00	0,79	46,52	0,99	17311	34497
VSM-50	50,00	47,99	3,00	0,79	48,52	0,99	18032	35935
VSM-52	52,00	49,48	4,01	0,79	50,06	0,99	24583	37372
VSM-55	55,00	52,46	4,01	0,79	53,06	0,99	26001	39528
VSM-56	56,00	53,44	4,01	0,79	54,06	0,99	26473	40247
VSM-58	58,00	55,42	4,01	0,79	56,06	0,99	27419	41684
VSM-60	60,00	57,40	4,01	0,79	58,06	0,99	28364	43122
VSM-62	62,00	59,37	4,01	0,79	60,06	0,99	29310	44559
VSM-63	63,00	60,35	4,01	0,79	61,06	0,99	29783	45278
VSM-65	65,00	62,33	4,01	0,79	63,06	0,99	30728	46715
VSM-68	68,00	65,31	4,01	0,79	66,06	0,99	32146	48871
VSM-70	70,00	67,29	4,01	0,79	68,06	0,99	33092	50309
VSM-72	72,00	69,27	4,01	0,79	70,06	0,99	34037	51746
VSM-75	75,00	72,25	4,01	0,79	73,06	0,99	35456	53902

¹ Add suffix "-S02" for 302 stainless steel. Add suffix "-S16" for 316 stainless steel.

² Based on a groove material yield strength of 310 N/mm² and a safety factor of 2.

³ Based on a safety factor of 3.

⁴ See pages 134 – 135 for How to Order.

Stock Items available in carbon steel and 302 and 316 stainless steel.

Product Dimensions All dimensions in millimeters unless otherwise specified.

Smalley Part Number ^{1,4}	Shaft Diameter	Ring			Groove		Thrust Capacity	
		Inside Diameter	Radial Wall	Thickness	Diameter	Width	Groove Yield (N) ²	Ring Shear (N) ³
VSM-78	78,00	74,85	4,78	0,99	75,66	1,12	44477	70250
VSM-80	80,00	76,82	4,78	0,99	77,66	1,12	45617	72052
VSM-82	82,00	78,79	4,78	0,99	79,66	1,12	46757	73853
VSM-85	85,00	81,76	4,78	0,99	82,66	1,12	48468	76555
VSM-88	88,00	84,73	4,78	0,99	85,66	1,12	50179	79257
VSM-90	90,00	86,69	4,78	0,99	87,66	1,12	51319	81058
VSM-95	95,00	91,66	4,78	0,99	92,66	1,12	54170	85561
VSM-100	100,00	96,62	4,78	0,99	97,66	1,12	57021	90064
VSM-105	105,00	101,13	5,72	1,17	102,20	1,32	71642	106440
VSM-110	110,00	106,08	5,72	1,17	107,20	1,32	75054	111508
VSM-115	115,00	111,03	5,72	1,17	112,20	1,32	78465	116577
VSM-120	120,00	115,98	5,72	1,17	117,20	1,32	81877	121645
VSM-125	125,00	120,93	5,72	1,17	122,20	1,32	85288	126714
VSM-130	130,00	125,88	5,72	1,17	127,20	1,32	88700	131783
VSM-135	135,00	130,31	5,72	1,55	131,63	1,70	111027	181299
VSM-140	140,00	135,13	5,72	1,55	136,50	1,70	119404	188013
VSM-145	145,00	139,95	5,72	1,55	141,37	1,70	127974	197907
VSM-150	150,00	144,83	5,72	1,55	146,25	1,70	137070	201443
VSM-155	155,00	149,66	5,72	1,55	151,13	1,70	146361	208158
VSM-160	160,00	154,44	6,73	1,55	156,00	1,70	155956	214872
VSM-165	165,00	159,27	6,73	1,55	160,88	1,70	165855	221587
VSM-170	170,00	164,09	6,73	1,55	165,75	1,70	176059	228302
VSM-175	175,00	168,92	6,73	1,55	170,63	1,70	186568	235017
VSM-180	180,00	173,75	6,73	1,55	175,50	1,70	197381	241731
VSM-185	185,00	178,57	7,62	1,55	180,38	1,70	208499	248446
VSM-190	190,00	183,40	7,62	1,55	185,25	1,70	219922	255161
VSM-195	195,00	188,22	7,62	1,55	190,13	1,70	231649	261876
VSM-200	200,00	193,05	7,62	1,55	195,00	1,70	243681	268590
VSM-210	210,00	202,70	8,76	1,93	204,75	2,08	268658	351160
VSM-220	220,00	212,36	8,76	1,93	214,50	2,08	294854	367882
VSM-230	230,00	222,01	8,76	1,93	224,25	2,08	322268	384604
VSM-240	240,00	231,66	8,76	1,93	234,00	2,08	350900	401326
VSM-250	250,00	241,31	8,76	1,93	243,75	2,08	380751	418048
VSM-260	260,00	250,97	9,65	1,93	253,50	2,08	411821	434770
VSM-270	270,00	260,62	9,65	1,93	263,25	2,08	444108	451492
VSM-280	280,00	270,27	9,65	1,93	273,00	2,08	477614	468214
VSM-290	290,00	279,92	9,65	1,93	282,75	2,08	512339	484936
VSM-300	300,00	289,58	9,65	1,93	292,50	2,08	548282	501658

¹ Add suffix "-S02" for 302 stainless steel. Add suffix "-S16" for 316 stainless steel.
² Based on a groove material yield strength of 310 N/mm² and a safety factor of 2.
³ Based on a safety factor of 3.
⁴ See pages 134 – 135 for How to Order.

Stock Items available in carbon steel and 302 and 316 stainless steel.



MA 4016⁵

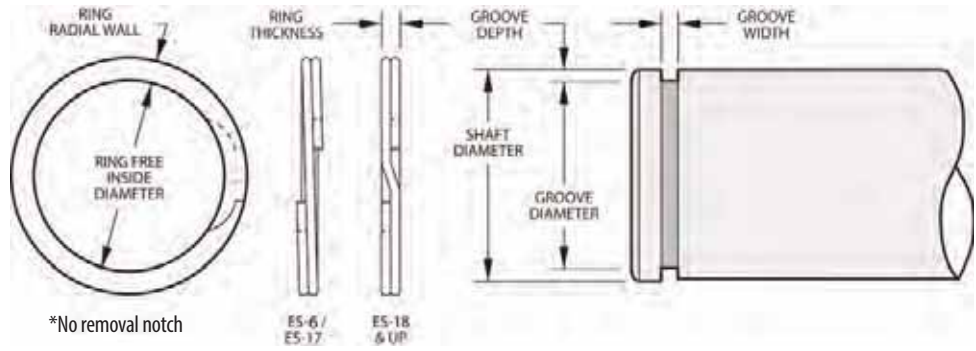

Product Dimensions All dimensions in millimeters unless otherwise specified.

Smalley Part Number ^{1,4}	Shaft Diameter	Ring			Groove		Thrust Capacity	
		Inside Diameter	Radial Wall	Thickness	Diameter	Width	Groove Yield (N) ²	Ring Shear (N) ³
ES-6 *	6,00	5,61	0,38 - 0,58	0,64	5,66	0,74	500	3160
ES-7 *	7,00	6,53	0,51 - 0,71	0,64	6,58	0,74	720	3690
ES-8 *	8,00	7,49	0,51 - 0,71	0,64	7,57	0,74	840	4210
ES-9 *	9,00	8,41	0,64 - 0,84	0,64	8,48	0,74	1140	4740
ES-10 *	10,00	9,40	0,64 - 0,84	0,64	9,50	0,74	1220	5270
ES-11	11,00	10,39	0,76 - 0,96	0,64	10,46	0,74	1450	5790
ES-12	12,00	11,18	1,02 - 1,22	0,60	11,29	0,70	2100	7950
ES-13	13,00	12,13	1,14 - 1,35	0,89	12,24	1,00	2410	12100
ES-14	14,00	13,06	1,14 - 1,35	0,89	13,19	1,00	2800	13040
ES-15	15,00	13,98	1,14 - 1,35	0,89	14,09	1,00	3360	13970
ES-16	16,00	14,90	1,27 - 1,48	0,89	15,02	1,00	3820	14900
ES-17	17,00	15,82	1,27 - 1,48	0,89	16,02	1,00	4060	15830
ES-18	18,00	16,80	1,52 - 1,73	1,07	16,92	1,20	4730	20150
ES-19	19,00	17,73	1,52 - 1,73	1,07	17,87	1,20	5270	21270
ES-20	20,00	18,62	1,52 - 1,73	1,07	18,77	1,20	6040	22390
ES-21	21,00	19,57	1,52 - 1,73	1,07	19,72	1,20	6550	23510
ES-22	22,00	20,45	1,78 - 1,98	1,07	20,62	1,20	7390	24630
ES-23	23,00	21,39	1,78 - 1,98	1,07	21,57	1,20	8070	25750
ES-24	24,00	22,35	1,78 - 1,98	1,07	22,52	1,20	8650	26870
ES-25	25,00	23,25	2,03 - 2,24	1,07	23,42	1,20	9620	27990
ES-26	26,00	24,21	2,03 - 2,24	1,07	24,42	1,20	10000	29110
ES-27	27,00	25,04	2,49 - 2,69	1,27	25,35	1,40	10910	31170
ES-28	28,00	26,00	2,49 - 2,69	1,27	26,30	1,40	11590	32330
ES-29	29,00	26,95	2,49 - 2,69	1,27	27,27	1,40	12290	33480
ES-30	30,00	27,92	2,49 - 2,69	1,27	28,25	1,40	12860	34640
ES-31	31,00	28,84	2,49 - 2,69	1,27	29,17	1,40	13890	35790
ES-32	32,00	29,77	2,49 - 2,69	1,27	30,09	1,40	14960	36950
ES-34	34,00	31,54	2,87 - 3,07	1,27	31,90	1,40	17390	39260
ES-35	35,00	32,44	2,87 - 3,07	1,27	32,80	1,40	18750	40410
ES-36	36,00	33,40	2,87 - 3,07	1,27	33,75	1,40	19810	41560
ES-37	37,00	34,24	2,87 - 3,07	1,27	34,67	1,40	21080	42720
ES-38	38,00	35,18	2,87 - 3,07	1,27	35,66	1,40	21650	43870
ES-40	40,00	37,15	3,12 - 3,33	1,57	37,55	1,75	23960	57090
ES-42	42,00	39,02	3,12 - 3,33	1,57	39,45	1,75	26180	59990
ES-45	45,00	41,77	3,12 - 3,33	1,57	42,25	1,75	30240	64230
ES-46	46,00	42,67	3,12 - 3,33	1,57	43,15	1,75	32040	65660
ES-47	47,00	43,81	3,89 - 4,09	1,57	44,31	1,75	30900	67080
ES-48	48,00	44,48	3,89 - 4,09	1,57	45,05	1,75	34600	68510
ES-50	50,00	46,69	3,89 - 4,09	1,57	47,05	1,75	36040	71370
ES-52	52,00	49,62	3,12 - 3,33	1,25	50,15	1,42	23550	59090
ES-53	53,00	50,62	3,12 - 3,33	1,25	51,15	1,42	24000	60230
ES-54	54,00	51,62	3,12 - 3,33	1,25	52,15	1,42	24460	61370
ES-55	55,00	52,62	3,38 - 3,58	1,25	53,15	1,42	24910	62500
ES-56	56,00	53,62	3,38 - 3,58	1,25	54,15	1,42	25370	63640
ES-58	58,00	55,43	3,38 - 3,58	1,25	56,01	1,42	28250	65910
ES-59	59,00	56,43	3,38 - 3,58	1,25	57,01	1,42	28730	67050

¹ Add suffix "-S02" for 302 stainless steel, "-S16" for 316 stainless steel.

² Based on a groove material yield strength of 310 N/mm² and a safety factor of 2.

³ Based on a safety factor of 3.

⁴ See pages 134 - 135 for How to Order.

⁵ Contact Smalley for details/information on how to order parts to be in compliance with this specification.

Stock Items available in carbon steel and 302 and 316 stainless steel.

Product Dimensions All dimensions in millimeters unless otherwise specified.

Smalley Part Number ^{1,4}	Shaft Diameter	Ring			Groove		Thrust Capacity	
		Inside Diameter	Radial Wall	Thickness	Diameter	Width	Groove Yield (N) ²	Ring Shear (N) ³
ES-60	60,00	57,43	3,38 - 3,58	1,25	58,01	1,42	29220	68180
ES-61	61,00	58,36	3,38 - 3,58	1,25	58,91	1,42	31190	69320
ES-62	62,00	59,30	3,63 - 3,84	1,25	59,91	1,42	31710	70460
ES-63	63,00	60,30	3,63 - 3,84	1,25	60,91	1,42	32220	71590
ES-64	64,00	61,25	3,63 - 3,84	1,25	61,91	1,42	32730	72730
ES-65	65,00	62,20	3,63 - 3,84	1,25	62,81	1,42	34820	73870
ES-66	66,00	63,16	3,63 - 3,84	1,25	63,79	1,42	35680	75000
ES-67	67,00	64,16	3,63 - 3,84	1,25	64,71	1,42	37530	76140
ES-68	68,00	65,08	3,89 - 4,09	1,25	65,71	1,42	38090	77270
ES-69	69,00	66,06	3,89 - 4,09	1,25	66,71	1,42	38650	78410
ES-70	70,00	67,08	3,89 - 4,09	1,25	67,71	1,42	39210	79550
ES-71	71,00	68,04	3,89 - 4,09	1,25	68,71	1,42	39770	80680
ES-72	72,00	69,00	4,11 - 4,37	1,25	69,65	1,42	41380	81820
ES-75	75,00	71,93	4,11 - 4,37	1,25	72,61	1,42	43830	85230
ES-78	78,00	74,84	4,11 - 4,37	1,55	75,55	1,73	46730	109910
ES-80	80,00	76,80	4,37 - 4,62	1,55	77,51	1,73	48700	112730
ES-82	82,00	78,72	4,37 - 4,62	1,55	79,45	1,73	51120	115550
ES-85	85,00	81,62	4,62 - 4,88	1,55	82,35	1,73	55060	119780
ES-88	88,00	84,53	4,62 - 4,88	1,55	85,31	1,73	57860	124000
ES-90	90,00	86,43	4,88 - 5,13	1,55	87,21	1,73	61370	126820
ES-95	95,00	91,37	4,88 - 5,13	1,55	92,15	1,73	66160	133870
ES-100	100,00	96,10	5,13 - 5,38	1,55	97,01	1,73	73050	140910
ES-105	105,00	100,94	5,38 - 5,64	1,55	101,85	1,73	80780	147960
ES-110	110,00	105,75	5,64 - 5,89	1,55	106,69	1,73	88930	155000
ES-115	115,00	110,59	5,89 - 6,15	1,55	111,55	1,73	96890	162050
ES-120	120,00	115,49	6,20 - 6,45	1,83	116,45	2,00	104030	199640
ES-125	125,00	120,44	6,20 - 6,45	1,83	121,45	2,00	108360	207960
ES-130	130,00	125,34	6,20 - 6,45	1,83	126,35	2,00	115860	216280
ES-135	135,00	130,20	6,20 - 6,45	1,83	131,27	2,00	122950	224600
ES-140	140,00	135,14	6,20 - 6,45	1,83	136,25	2,00	128190	232920
ES-145	145,00	140,00	6,20 - 6,45	1,83	141,17	2,00	135590	241230
ES-150	150,00	145,00	6,20 - 6,45	1,83	146,17	2,00	140260	249550
ES-155	155,00	149,33	7,72 - 8,03	2,18	150,60	2,40	166080	307190
ES-160	160,00	154,31	7,72 - 8,03	2,18	155,60	2,40	171430	317100
ES-165	165,00	159,23	7,72 - 8,03	2,18	160,60	2,40	176790	327010
ES-170	170,00	164,00	7,72 - 8,03	2,18	165,40	2,40	190430	336920
ES-175	175,00	169,00	7,72 - 8,03	2,18	170,40	2,40	196030	346830
ES-180	180,00	173,78	7,72 - 8,03	2,18	175,20	2,40	210400	356740
ES-185	185,00	178,70	7,72 - 8,03	2,18	180,20	2,40	216240	366650
ES-190	190,00	183,70	7,72 - 8,03	2,18	185,20	2,40	220080	376560
ES-195	195,00	188,43	7,72 - 8,03	2,18	190,00	2,40	237420	386460
ES-200	200,00	193,43	7,72 - 8,03	2,18	195,00	2,40	243510	396370
ES-210	210,00	202,93	9,32 - 9,63	2,18	204,60	2,40	276140	416190
ES-220	220,00	212,65	9,32 - 9,63	2,18	214,40	2,40	300010	436010
ES-230	230,00	222,60	9,32 - 9,63	2,18	224,40	2,40	313640	455830
ES-240	240,00	232,32	9,32 - 9,63	2,18	234,20	2,40	328970	475650
ES-250	250,00	241,83	9,32 - 9,63	2,18	243,80	2,40	377440	495470
ES-260	260,00	251,57	9,32 - 9,63	2,18	253,60	2,40	405210	515290
ES-270	270,00	261,30	9,32 - 9,63	2,18	263,40	2,40	433940	535100
ES-280	280,00	271,04	9,32 - 9,63	2,18	273,20	2,40	463650	554920

¹ Add suffix "-S02" for 302 stainless steel, "-S16" for 316 stainless steel.

² Based on a groove material yield strength of 310 N/mm² and a safety factor of 2.

³ Based on a safety factor of 3.

⁴ See pages 134 –135 for How to Order.

⁵ Contact Smalley for details/information on how to order parts to be in compliance with this specification.

Stock Items available in carbon steel and 302 and 316 stainless steel.

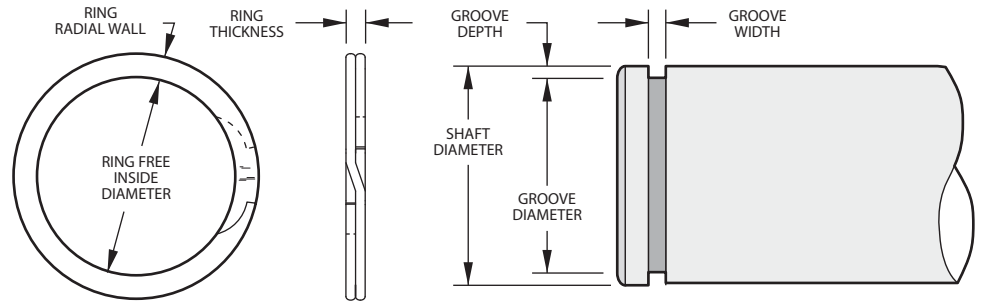

Groove Compatible with DIN 471

Product Dimensions All dimensions in millimeters unless otherwise specified.

Smalley Part Number ^{1,4}	Shaft Diameter	Ring			Groove		Thrust Capacity	
		Inside Diameter	Radial Wall	Thickness	Diameter	Width	Groove Yield (N) ²	Ring Shear (N) ³
DNS-13	13,00	12,27	1,40	0,99	12,40	1,10	1901	13474
DNS-14	14,00	13,26	1,40	0,99	13,40	1,10	2047	14510
DNS-15	15,00	14,15	1,40	0,99	14,30	1,10	2559	15547
DNS-16	16,00	15,04	1,65	0,99	15,20	1,10	3119	16583
DNS-17	17,00	16,04	1,65	0,99	16,20	1,10	3314	17620
DNS-18	18,00	16,83	1,91	1,14	17,00	1,30	4386	18668
DNS-19	19,00	17,83	1,91	1,14	18,00	1,30	4630	19705
DNS-20	20,00	18,82	1,91	1,14	19,00	1,30	4874	20742
DNS-21	21,00	19,79	1,91	1,14	20,00	1,30	5117	21779
DNS-22	22,00	20,78	1,91	1,14	21,00	1,30	5361	22816
DNS-23	23,00	21,77	1,91	1,14	22,00	1,30	5605	23853
DNS-24	24,00	22,66	2,18	1,14	22,90	1,30	6433	24891
DNS-25	25,00	23,65	2,18	1,14	23,90	1,30	6701	25928
DNS-26	26,00	24,64	2,18	1,14	24,90	1,30	6969	26965
DNS-27	27,00	25,34	2,18	1,14	25,60	1,30	9211	28002
DNS-28	28,00	26,34	2,39	1,44	26,60	1,60	9552	36681
DNS-29	29,00	27,33	2,39	1,44	27,60	1,60	9893	37991
DNS-30	30,00	28,32	2,39	1,44	28,60	1,60	10235	39301
DNS-32	32,00	30,00	3,25	1,44	30,30	1,60	13256	41921
DNS-33	33,00	30,99	3,25	1,44	31,30	1,60	13670	43231
DNS-34	34,00	31,98	3,25	1,44	32,30	1,60	14085	44541
DNS-35	35,00	32,66	3,25	1,44	33,00	1,60	17058	45851
DNS-36	36,00	33,65	4,01	1,69	34,00	1,85	17545	55349
DNS-38	38,00	35,64	4,01	1,69	36,00	1,85	18520	58424
DNS-40	40,00	37,11	4,01	1,69	37,50	1,85	24368	61498
DNS-42	42,00	39,09	4,01	1,69	39,50	1,85	25586	64573
DNS-45	45,00	42,06	4,01	1,69	42,50	1,85	27414	69186
DNS-46	46,00	43,05	4,01	1,69	43,50	1,85	28023	70723
DNS-47	47,00	44,04	4,01	1,69	44,50	1,85	28633	72261
DNS-48	48,00	45,03	4,01	1,69	45,50	1,85	29242	73798
DNS-50	50,00	46,53	5,08	1,93	47,00	2,15	36552	87790
DNS-52	52,00	48,51	5,08	1,93	49,00	2,15	38014	91302
DNS-54	54,00	50,50	5,08	1,93	51,00	2,15	39476	94813
DNS-55	55,00	51,49	5,08	1,93	52,00	2,15	40207	96569
DNS-56	56,00	52,48	5,08	1,93	53,00	2,15	40938	98325
DNS-58	58,00	54,43	5,08	1,93	55,00	2,15	42400	101836
DNS-60	60,00	56,42	5,08	1,93	57,00	2,15	43863	105348
DNS-62	62,00	58,42	5,08	1,93	59,00	2,15	45325	108860
DNS-63	63,00	59,39	5,08	1,93	60,00	2,15	46056	110615
DNS-65	65,00	61,39	5,08	2,41	62,00	2,65	47518	135725
DNS-67	67,00	63,37	5,08	2,41	64,00	2,65	48980	139901
DNS-68	68,00	64,34	5,08	2,41	65,00	2,65	49711	141989
DNS-70	70,00	66,34	5,08	2,41	67,00	2,65	51173	146165
DNS-72	72,00	68,33	5,08	2,41	69,00	2,65	52635	150341
DNS-75	75,00	71,33	5,08	2,41	72,00	2,65	54828	156605

¹ Add suffix "-S02" for 302 stainless steel, "-S16" for 316 stainless steel.

² Based on a groove material yield strength of 310 N/mm² and a safety factor of 2.

³ Based on a safety factor of 3.

⁴ See pages 134 – 135 for How to Order.

Stock Items available in carbon steel and 302 and 316 stainless steel.

Product Dimensions All dimensions in millimeters unless otherwise specified.

Smalley Part Number ^{1,4}	Shaft Diameter	Ring			Groove		Thrust Capacity	
		Inside Diameter	Radial Wall	Thickness	Diameter	Width	Groove Yield (N) ²	Ring Shear (N) ³
DNS-77	77,00	73,33	5,08	2,41	74,00	2,65	56290	160782
DNS-78	78,00	74,33	5,08	2,41	75,00	2,65	57021	162870
DNS-80	80,00	75,81	6,05	2,41	76,50	2,65	68231	167046
DNS-82	82,00	77,81	6,05	2,41	78,50	2,65	69936	171222
DNS-85	85,00	80,80	6,35	2,91	81,50	3,15	72495	214309
DNS-88	88,00	83,80	6,35	2,91	84,50	3,15	75054	221873
DNS-90	90,00	85,80	6,35	2,91	86,50	3,15	76759	226915
DNS-95	95,00	90,80	6,35	2,91	91,50	3,15	81024	239522
DNS-98	98,00	93,79	6,35	2,91	94,50	3,15	83583	247086
DNS-100	100,00	95,79	6,35	2,91	96,50	3,15	85288	252128
DNS-102	102,00	97,29	6,73	3,89	98,00	4,15	99422	343778
DNS-105	105,00	100,28	6,73	3,89	101,00	4,15	102346	353889
DNS-108	108,00	103,25	6,73	3,89	104,00	4,15	105270	364000
DNS-110	110,00	105,23	6,73	3,89	106,00	4,15	107220	370741
DNS-115	115,00	110,19	6,73	3,89	111,00	4,15	112093	387593
DNS-120	120,00	115,16	6,73	3,89	116,00	4,15	116967	404445
DNS-125	125,00	120,12	6,73	3,89	121,00	4,15	121840	421297
DNS-130	130,00	125,07	6,73	3,89	126,00	4,15	126714	438149
DNS-135	135,00	130,02	6,73	3,89	131,00	4,15	131588	455001
DNS-140	140,00	134,98	6,73	3,89	136,00	4,15	136461	471852
DNS-145	145,00	139,93	6,73	3,89	141,00	4,15	141335	488704
DNS-150	150,00	143,91	7,92	3,89	145,00	4,15	182761	505556
DNS-155	155,00	148,89	7,92	3,89	150,00	4,15	188853	522408
DNS-160	160,00	153,85	7,92	3,89	155,00	4,15	194945	539260
DNS-165	165,00	158,80	7,92	3,89	160,00	4,15	201037	556112
DNS-170	170,00	163,75	7,92	3,89	165,00	4,15	207129	572964
DNS-175	175,00	168,73	7,92	3,89	170,00	4,15	213221	589815
DNS-180	180,00	173,69	7,92	3,89	175,00	4,15	219313	606667
DNS-185	185,00	178,66	7,92	3,89	180,00	4,15	225405	623519
DNS-190	190,00	183,59	7,92	3,89	185,00	4,15	231497	640371
DNS-195	195,00	188,54	7,92	3,89	190,00	4,15	237589	657223
DNS-200	200,00	193,54	7,92	3,89	195,00	4,15	243681	674075
DNS-205	205,00	197,54	11,18	4,86	199,00	5,15	299727	863214
DNS-210	210,00	202,54	11,18	4,86	204,00	5,15	307038	884268
DNS-220	220,00	212,47	11,18	4,86	214,00	5,15	321659	926376
DNS-230	230,00	222,40	11,18	4,86	224,00	5,15	336280	968484
DNS-240	240,00	232,33	11,18	4,86	234,00	5,15	350900	1010592
DNS-250	250,00	242,24	11,18	4,86	244,00	5,15	365521	1052700
DNS-260	260,00	250,19	12,70	4,86	252,00	5,15	506856	1094808
DNS-270	270,00	260,15	12,70	4,86	262,00	5,15	526351	1136916
DNS-280	280,00	270,08	12,70	4,86	272,00	5,15	545845	1179024
DNS-290	290,00	279,98	12,70	4,86	282,00	5,15	565340	1221132
DNS-300	300,00	289,92	12,70	4,86	292,00	5,15	584834	1263241
DNS-310	310,00	297,84	15,88	5,87	300,00	6,20	755411	1576625
DNS-320	320,00	307,84	15,88	5,87	310,00	6,20	779779	1627484
DNS-330	330,00	317,75	15,88	5,87	320,00	6,20	804147	1678342
DNS-340	340,00	327,69	15,88	5,87	330,00	6,20	828515	1729201
DNS-350	350,00	337,64	15,88	5,87	340,00	6,20	852883	1780060
DNS-360	360,00	347,57	15,88	5,87	350,00	6,20	877251	1830919
DNS-370	370,00	357,48	15,88	5,87	360,00	6,20	901619	1881778
DNS-380	380,00	367,41	15,88	5,87	370,00	6,20	925987	1932637
DNS-390	390,00	377,34	15,88	5,87	380,00	6,20	950355	1983496
DNS-400	400,00	387,25	15,88	5,87	390,00	6,20	974723	2034354

¹ Add suffix "-S02" for 302 stainless steel, "-S16" for 316 stainless steel.

² Based on a groove material yield strength of 310 N/mm² and a safety factor of 2.

³ Based on a safety factor of 3.

⁴ See pages 134 –135 for How to Order.

Stock Items available in carbon steel and 302 stainless steel.



Groove Compatible with DIN 471

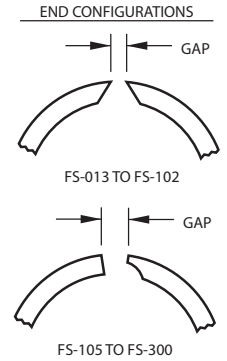
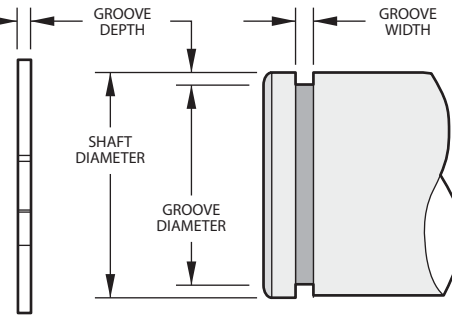
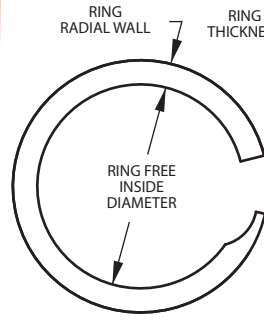

Product Dimensions All dimensions in millimeters unless otherwise specified.

Smalley Part Number ^{1,4}	Shaft Diameter	Ring			Groove		Thrust Capacity	
		Inside Diameter	Radial Wall	Thickness	Diameter	Width	Groove Yield (N) ²	Ring Shear (N) ³
FS-013	13,00	12,27	1,40	0,94	12,40	1,10	1931	10591
FS-014	14,00	13,31	1,40	0,94	13,40	1,10	2077	11396
FS-015	15,00	14,15	1,40	0,94	14,30	1,10	2602	12224
FS-016	16,00	14,98	1,65	0,94	15,20	1,10	3172	13029
FS-017	17,00	16,06	1,65	0,94	16,20	1,10	3367	13838
FS-018	18,00	16,82	1,90	1,15	17,00	1,30	4457	17953
FS-019	19,00	17,81	1,90	1,15	18,00	1,30	4702	18941
FS-020	20,00	18,80	1,90	1,15	19,00	1,30	4951	19928
FS-021	21,00	19,79	1,90	1,15	20,00	1,30	5200	20942
FS-022	22,00	20,83	1,90	1,15	21,00	1,30	5445	21930
FS-023	23,00	21,77	1,90	1,15	22,00	1,30	5698	22939
FS-024	24,00	22,50	2,15	1,15	22,90	1,30	6539	23927
FS-025	25,00	23,70	2,15	1,15	23,90	1,30	6806	24914
FS-026	26,00	24,64	2,15	1,15	24,90	1,30	7082	25929
FS-027	27,00	25,50	2,15	1,15	25,90	1,30	7353	26916
FS-028	28,00	26,32	3,25	1,44	26,60	1,60	9702	33179
FS-029	29,00	27,15	3,25	1,44	27,60	1,60	10053	34385
FS-030	30,00	28,35	3,25	1,44	28,60	1,60	10395	35559
FS-032	32,00	29,87	3,25	1,44	30,30	1,60	13073	37939
FS-033	33,00	31,07	3,25	1,44	31,30	1,60	13478	39113
FS-034	34,00	31,96	3,25	1,44	32,30	1,60	13892	40319
FS-035	35,00	32,57	3,25	1,44	33,00	1,60	16899	41493
FS-036	36,00	33,64	4,01	1,69	34,00	1,85	17375	50038
FS-038	38,00	35,62	4,01	1,69	36,00	1,85	18344	52827
FS-040	40,00	37,02	4,01	1,69	37,50	1,85	24265	55621
FS-042	42,00	39,08	4,01	1,69	39,50	1,85	25484	58410
FS-045	45,00	42,05	4,01	1,69	42,50	1,85	27303	62578
FS-046	46,00	43,10	4,01	1,69	43,50	1,85	27904	63952
FS-047	47,00	44,03	4,01	1,69	44,50	1,85	28504	65331
FS-048	48,00	44,89	4,01	1,69	45,50	1,85	29118	66741
FS-050	50,00	46,50	5,08	1,93	47,00	2,15	36529	75282
FS-052	52,00	48,48	5,08	1,93	49,00	2,15	37974	78266
FS-054	54,00	50,46	5,08	1,93	51,00	2,15	39438	81287
FS-055	55,00	51,45	5,08	1,93	52,00	2,15	40163	82777
FS-056	56,00	52,44	5,08	1,93	53,00	2,15	40906	84307
FS-058	58,00	54,42	5,08	1,93	55,00	2,15	42352	87287
FS-060	60,00	56,55	5,08	1,93	57,00	2,15	43819	90308
FS-062	62,00	58,32	5,08	1,93	59,00	2,15	45283	93328
FS-063	63,00	59,37	5,08	1,93	60,00	2,15	46008	94823
FS-065	65,00	61,35	5,08	2,41	62,00	2,65	47471	116641
FS-067	67,00	63,35	5,08	2,41	64,00	2,65	48939	120240
FS-068	68,00	64,45	5,08	2,41	65,00	2,65	49660	122019
FS-070	70,00	66,22	5,08	2,41	67,00	2,65	51128	125618
FS-072	72,00	68,28	5,08	2,41	69,00	2,65	52591	129221
FS-075	75,00	71,25	5,08	2,41	72,00	2,65	54780	134599

¹ Add suffix "-S02" for 302 stainless steel.

² Based on a groove material yield strength of 310 N/mm² and a safety factor of 2.

³ Based on a safety factor of 3.

⁴ See pages 134 – 135 for How to Order.

Stock Items available in carbon steel and 302 stainless steel.

Product Dimensions All dimensions in millimeters unless otherwise specified.

Smalley Part Number ^{1,4}	Shaft Diameter	Ring			Groove		Thrust Capacity	
		Inside Diameter	Radial Wall	Thickness	Diameter	Width	Groove Yield (N) ²	Ring Shear (N) ³
FS-077	77,00	73,23	5,08	2,41	74,00	2,65	56230	138153
FS-078	78,00	74,06	5,08	2,41	75,00	2,65	56968	139977
FS-080	80,00	75,70	6,02	2,41	76,50	2,65	68342	143575
FS-082	82,00	77,68	6,02	2,41	78,50	2,65	70033	147134
FS-085	85,00	80,65	6,30	2,91	81,50	3,15	72595	175656
FS-088	88,00	83,60	6,30	2,91	84,50	3,15	75175	181906
FS-090	90,00	85,80	6,30	2,91	86,50	3,15	76865	185998
FS-095	95,00	90,68	6,30	2,91	91,50	3,15	81140	196340
FS-098	98,00	93,70	6,30	2,91	94,50	3,15	83702	202536
FS-100	100,00	95,50	6,30	2,91	96,50	3,15	85415	206682
FS-102	102,00	97,23	6,30	2,91	98,50	3,15	87127	210828
FS-105	105,00	99,83	6,73	3,89	101,00	4,15	102687	276951
FS-108	108,00	102,87	6,73	3,89	104,00	4,15	105619	284855
FS-110	110,00	104,90	6,73	3,89	106,00	4,15	107580	290149
FS-115	115,00	109,85	6,73	3,89	111,00	4,15	112473	303346
FS-120	120,00	115,06	6,73	3,89	116,00	4,15	117344	316478
FS-125	125,00	119,75	6,73	3,89	121,00	4,15	122237	329676
FS-130	130,00	124,70	6,73	3,89	126,00	4,15	127130	342873
FS-135	135,00	129,65	6,73	3,89	131,00	4,15	132023	356071
FS-140	140,00	134,42	6,73	3,89	136,00	4,15	136916	369269
FS-145	145,00	139,55	6,73	3,89	141,00	4,15	141809	382467
FS-150	150,00	143,50	8,03	3,89	145,00	4,15	181986	395665
FS-155	155,00	148,45	8,03	3,89	150,00	4,15	188026	408796
FS-160	160,00	153,40	8,03	3,89	155,00	4,15	194094	421994
FS-165	165,00	158,40	8,03	3,89	160,00	4,15	200166	435192
FS-170	170,00	163,30	8,03	3,89	165,00	4,15	206237	448683
FS-175	175,00	168,25	8,03	3,89	170,00	4,15	212305	461890
FS-180	180,00	173,20	8,03	3,89	175,00	4,15	218377	475097
FS-185	185,00	177,62	8,03	3,89	180,00	4,15	224417	488232
FS-190	190,00	183,35	8,03	3,89	185,00	4,15	230489	501439
FS-195	195,00	188,05	8,03	3,89	190,00	4,15	236556	514646
FS-200	200,00	193,00	8,03	3,89	195,00	4,15	242628	527853
FS-205	205,00	196,95	11,05	4,87	199,00	5,15	299454	641438
FS-210	210,00	201,67	11,05	4,87	204,00	5,15	306763	657096
FS-220	220,00	211,80	11,05	4,87	214,00	5,15	321344	688327
FS-230	230,00	221,70	11,05	4,87	224,00	5,15	335961	719638
FS-240	240,00	231,89	11,05	4,87	234,00	5,15	350578	750953
FS-250	250,00	241,50	11,05	4,87	244,00	5,15	365199	782264
FS-260	260,00	249,59	12,70	4,87	252,00	5,15	505300	813500
FS-270	270,00	259,30	12,70	4,87	262,00	5,15	524748	844811
FS-280	280,00	268,83	12,70	4,87	272,00	5,15	544200	876126
FS-290	290,00	279,10	12,70	4,87	282,00	5,15	563599	907357
FS-300	300,00	289,00	12,70	4,87	292,00	5,15	583051	938673

¹ Add suffix "-S02" for 302 stainless steel.

² Based on a groove material yield strength of 310 N/mm² and a safety factor of 2.

³ Based on a safety factor of 3.

⁴ See pages 134 –135 for How to Order.

Stock Items available in carbon steel and 302 stainless steel.

Smalley Part Number ^{1,3}	Shaft Diameter	Ring			Groove		Groove Yield (N) ²
		Inside Diameter	Radial Wall	Thickness	Diameter ⁴	Width	
HSM-10	10	9,37	0,43	1,14	9,57	1,27	1051
HSM-11	11	10,35	0,43	1,14	10,57	1,27	1156
HSM-12	12	11,33	0,43	1,14	11,57	1,27	1262
HSM-13	13	12,21	0,53	1,65	12,47	1,78	1688
HSM-14	14	13,19	0,53	1,65	13,47	1,78	1818
HSM-15	15	14,17	0,53	1,65	14,47	1,78	1948
HSM-16	16	15,15	0,53	1,65	15,47	1,78	2078
HSM-17	17	16,13	0,53	1,65	16,47	1,78	2208
HSM-18	18	17,03	0,61	2,24	17,39	2,36	2672
HSM-19	19	18,01	0,61	2,24	18,39	2,36	2820
HSM-20	20	18,99	0,61	2,24	19,39	2,36	2968
HSM-21	21	19,97	0,61	2,24	20,39	2,36	3117
HSM-22	22	20,95	0,61	2,24	21,39	2,36	3265
HSM-23	23	21,93	0,61	2,24	22,39	2,36	3414
HSM-24	24	22,91	0,61	2,24	23,39	2,36	3562
HSM-25	25	23,89	0,61	2,24	24,39	2,36	3711
HSM-26	26	24,72	0,76	3,00	25,24	3,12	4824
HSM-27	27	25,70	0,76	3,00	26,24	3,12	5009
HSM-28	28	26,68	0,76	3,00	27,24	3,12	5195
HSM-29	29	27,66	0,76	3,00	28,24	3,12	5380
HSM-30	30	28,64	0,76	3,00	29,24	3,12	5566
HSM-31	31	29,62	0,76	3,00	30,24	3,12	5751
HSM-32	32	30,60	0,76	3,00	31,24	3,12	5937
HSM-33	33	31,48	0,86	3,81	32,14	3,94	6939
HSM-34	34	32,46	0,86	3,81	33,14	3,94	7149
HSM-35	35	33,44	0,86	3,81	34,14	3,94	7359
HSM-36	36	34,42	0,86	3,81	35,14	3,94	7569
HSM-37	37	35,40	0,86	3,81	36,14	3,94	7780
HSM-38	38	36,38	0,86	3,81	37,14	3,94	7990
HSM-40	40	38,34	0,86	3,81	39,14	3,94	8411
HSM-41	41	39,32	0,86	3,81	40,14	3,94	8621
HSM-42	42	40,30	0,86	3,81	41,14	3,94	8831
HSM-45	45	43,13	0,97	4,75	44,03	4,88	10575
HSM-47	47	45,09	0,97	4,75	46,03	4,88	11045
HSM-48	48	46,07	0,97	4,75	47,03	4,88	11280
HSM-50	50	48,03	0,97	4,75	49,03	4,88	11750
HSM-51	51	49,01	0,97	4,75	50,03	4,88	11985
HSM-52	52	49,99	0,97	4,75	51,03	4,88	12220
HSM-55	55	52,93	0,97	4,75	54,03	4,90	12925
HSM-56	56	53,91	0,97	4,75	55,03	4,90	13160
HSM-57	57	54,89	0,97	4,75	56,03	4,90	13395
HSM-58	58	55,87	0,97	4,75	57,03	4,90	13630
HSM-60	60	57,83	0,97	4,75	59,03	4,90	14100
HSM-62	62	59,62	1,14	5,72	60,86	5,87	17254
HSM-63	63	60,60	1,14	5,72	61,86	5,87	17532
HSM-64	64	61,58	1,14	5,72	62,86	5,87	17811
HSM-65	65	62,56	1,14	5,72	63,86	5,87	18089
HSM-67	67	64,52	1,14	5,72	65,86	5,87	18645
HSM-68	68	65,50	1,14	5,72	66,86	5,87	18924
HSM-70	70	67,46	1,14	5,72	68,86	5,87	19480
HSM-72	72	69,42	1,14	5,72	70,86	5,87	20037
HSM-75	75	72,36	1,14	5,72	73,86	5,87	20872
HSM-76	76	73,34	1,14	5,72	74,86	5,87	21150

¹ Add suffix "-S02" for 302 stainless steel.

² Based on a groove material yield strength of 310 N/mm² and a safety factor of 2.

³ See pages 134-135 for How to Order.

⁴ Sharp corners on the groove required, see page 129 for more information.

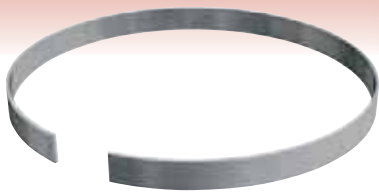

Product Dimensions

All dimensions in millimeters unless otherwise specified.

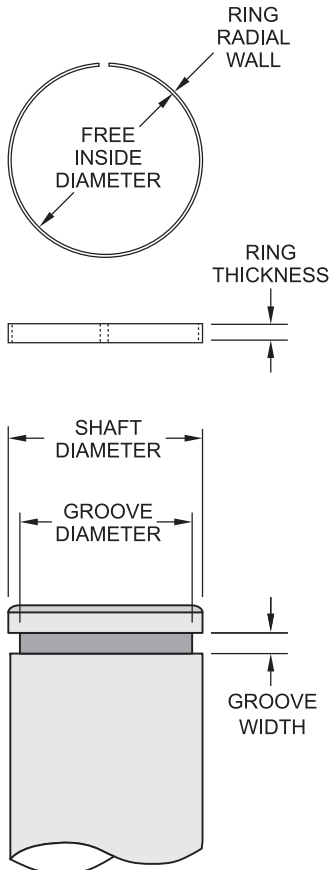

Stock Items available in carbon steel and 302 stainless steel.

Smalley Part Number ^{1,3}	Shaft Diameter	Ring			Groove		Groove Yield (lb) ²	
		Inside Diameter	Radial Wall	Thickness	Diameter ⁴	Width		
HS-37	0,375	0,351	±0,0017	0,017	0,045	0,358	0,050	225
HS-43	0,437	0,411	±0,0017	0,017	0,045	0,420	0,050	263
HS-46	0,469	0,443	+0,000/-0,012	0,017	0,045	0,452	0,050	282
HS-50	0,500	0,469	±0,0015	0,021	0,065	0,479	0,070	371
HS-53	0,531	0,499	±0,0015	0,021	0,065	0,510	0,070	394
HS-56	0,562	0,530	±0,0015	0,021	0,065	0,541	0,070	417
HS-59	0,594	0,561	±0,0015	0,021	0,065	0,573	0,070	441
HS-62	0,625	0,592	±0,0015	0,021	0,065	0,604	0,070	464
HS-65	0,656	0,622	±0,0015	0,021	0,065	0,635	0,070	487
HS-68	0,688	0,653	±0,0015	0,021	0,065	0,667	0,070	511
HS-71	0,718	0,680	±0,0015	0,024	0,088	0,694	0,093	609
HS-75	0,750	0,711	±0,0015	0,024	0,088	0,726	0,093	636
HS-78	0,781	0,741	±0,0015	0,024	0,088	0,757	0,093	662
HS-81	0,812	0,772	±0,0015	0,024	0,088	0,788	0,093	689
HS-84	0,843	0,802	±0,0015	0,024	0,088	0,819	0,093	715
HS-87	0,875	0,834	±0,0015	0,024	0,088	0,851	0,093	742
HS-90	0,906	0,864	±0,0015	0,024	0,088	0,882	0,093	768
HS-93	0,938	0,895	±0,0015	0,024	0,088	0,914	0,093	796
HS-96	0,968	0,925	±0,0015	0,024	0,088	0,944	0,093	821
HS-100	1,000	0,956	±0,0015	0,024	0,088	0,976	0,093	848
HS-103	1,031	0,980	±0,0015	0,030	0,118	1,001	0,123	1093
HS-106	1,062	1,011	±0,0015	0,030	0,118	1,032	0,123	1126
HS-109	1,093	1,041	±0,0015	0,030	0,118	1,063	0,123	1159
HS-112	1,125	1,073	±0,0015	0,030	0,118	1,095	0,123	1193
HS-115	1,156	1,103	±0,0015	0,030	0,118	1,126	0,123	1226
HS-118	1,188	1,134	±0,0015	0,030	0,118	1,158	0,123	1260
HS-121	1,218	1,164	±0,0015	0,030	0,118	1,188	0,123	1291
HS-125	1,250	1,195	±0,0015	0,030	0,118	1,220	0,123	1325
HS-128	1,281	1,225	±0,0015	0,030	0,118	1,251	0,123	1358
HS-131	1,312	1,252	±0,0015	0,034	0,150	1,278	0,155	1577
HS-134	1,343	1,282	±0,0015	0,034	0,150	1,309	0,155	1614
HS-137	1,375	1,314	±0,0015	0,034	0,150	1,341	0,155	1652
HS-140	1,406	1,344	±0,0015	0,034	0,150	1,372	0,155	1690
HS-143	1,437	1,374	±0,0015	0,034	0,150	1,403	0,155	1727
HS-146	1,468	1,405	±0,0015	0,034	0,150	1,434	0,155	1765
HS-150	1,500	1,436	±0,0015	0,034	0,150	1,466	0,155	1802
HS-156	1,562	1,497	±0,0015	0,034	0,150	1,528	0,155	1877
HS-162	1,625	1,559	±0,0015	0,034	0,150	1,591	0,155	1953
HS-168	1,688	1,619	±0,0015	0,034	0,150	1,653	0,155	2028
HS-175	1,750	1,677	±0,0015	0,038	0,187	1,712	0,193	2350
HS-181	1,812	1,739	±0,0015	0,038	0,187	1,775	0,193	2434
HS-187	1,875	1,800	±0,0015	0,038	0,187	1,837	0,193	2518
HS-193	1,938	1,861	±0,0015	0,038	0,187	1,900	0,193	2603
HS-200	2,000	1,922	±0,0015	0,038	0,187	1,962	0,193	2686
HS-206	2,062	1,983	±0,0015	0,038	0,187	2,024	0,193	2769
HS-212	2,125	2,045	±0,0015	0,038	0,187	2,087	0,193	2854
HS-218	2,188	2,106	±0,0015	0,038	0,187	2,150	0,193	2939
HS-225	2,250	2,167	±0,0015	0,038	0,187	2,212	0,193	3022
HS-231	2,312	2,228	±0,0015	0,038	0,187	2,274	0,193	3105
HS-237	2,375	2,290	±0,0015	0,038	0,187	2,337	0,193	3190
HS-243	2,437	2,343	±0,0015	0,045	0,225	2,392	0,232	3876
HS-250	2,500	2,405	±0,0015	0,045	0,225	2,455	0,232	3976
HS-256	2,562	2,466	±0,0015	0,045	0,225	2,517	0,232	4075
HS-262	2,625	2,528	±0,0015	0,045	0,225	2,580	0,232	4175
HS-268	2,688	2,589	±0,0015	0,045	0,225	2,643	0,232	4275
HS-275	2,750	2,650	±0,0015	0,045	0,225	2,705	0,232	4374
HS-281	2,812	2,712	±0,0015	0,045	0,225	2,768	0,232	4472
HS-287	2,875	2,773	±0,0015	0,045	0,225	2,830	0,232	4572
HS-293	2,938	2,833	±0,0015	0,045	0,225	2,892	0,232	4673
HS-300	3,000	2,895	±0,0015	0,045	0,225	2,955	0,232	4771

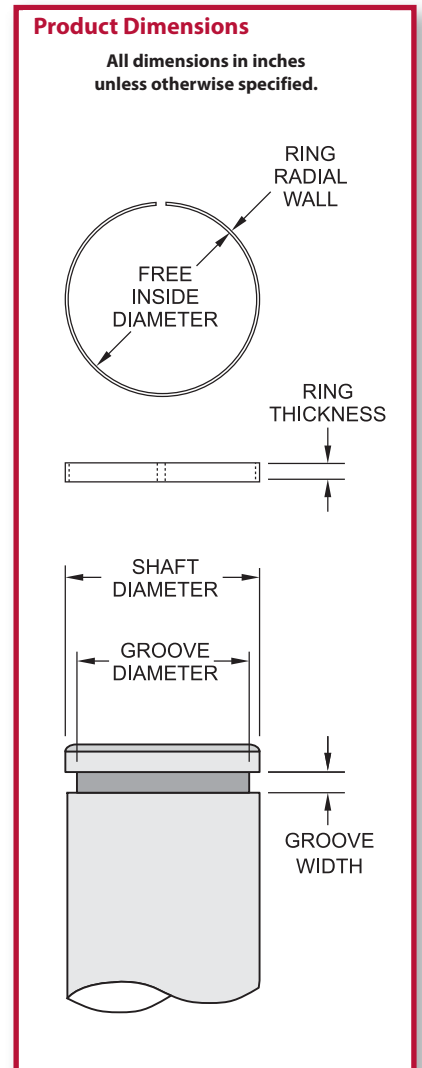

¹ Add suffix "-S02" for 302 stainless steel.

² Based on a groove material yield strength of 45,000 psi and a safety factor of 2.

³ See pages 134 -135 for How to Order.

⁴ Sharp corners on the groove required, see page 129 for more information.

⁵ 1 lb = 4,448 N

1 psi = 0,0069 N/mm²

1 inch = 25,4 mm

Stock Items available in carbon steel and 302 and 316 stainless steel.

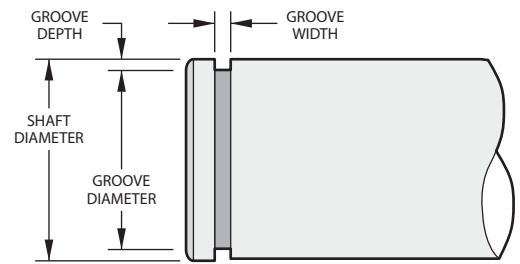
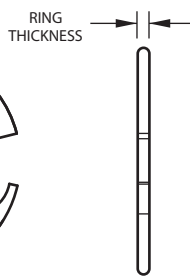
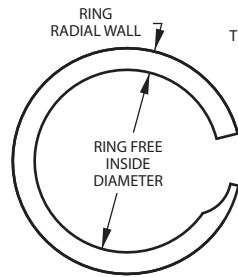
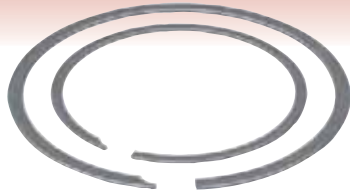

*No removal notch

Product Dimensions All dimensions in inches unless otherwise specified.

Smalley Part Number ^{1,4}	Shaft Diameter	Ring			Groove		Thrust Capacity	
		Inside Diameter	Radial Wall	Thickness	Diameter	Width	Groove Yield (lb) ²	Ring Shear (lb) ³
VS-25*	0,250	0,236	0,020	0,012	0,238	0,015	106	481
VS-31*	0,312	0,294	0,025	0,015	0,297	0,018	165	750
VS-37*	0,375	0,348	0,025	0,015	0,351	0,018	318	901
VS-43	0,437	0,410	0,035	0,015	0,413	0,018	371	1050
VS-50	0,500	0,467	0,045	0,018	0,472	0,022	500	1300
VS-56	0,562	0,529	0,045	0,018	0,534	0,022	560	1460
VS-62	0,625	0,591	0,045	0,018	0,597	0,022	620	1630
VS-68	0,687	0,652	0,045	0,018	0,659	0,022	680	1790
VS-75	0,750	0,715	0,045	0,018	0,722	0,022	740	1950
VS-81	0,812	0,762	0,065	0,021	0,770	0,026	1210	2460
VS-87	0,875	0,825	0,065	0,021	0,833	0,026	1300	2660
VS-93	0,937	0,886	0,065	0,021	0,895	0,026	1390	2840
VS-100	1,000	0,949	0,065	0,021	0,958	0,026	1480	3040
VS-106	1,062	1,008	0,088	0,025	1,018	0,031	1650	3500
VS-112	1,125	1,071	0,088	0,025	1,081	0,031	1750	3710
VS-118	1,187	1,132	0,088	0,025	1,143	0,031	1850	3920
VS-125	1,250	1,194	0,088	0,025	1,206	0,031	1940	4120
VS-131	1,312	1,255	0,088	0,025	1,268	0,031	2040	4330
VS-137	1,375	1,318	0,088	0,025	1,331	0,031	2140	4540
VS-143	1,437	1,379	0,088	0,025	1,393	0,031	2240	4740
VS-150	1,500	1,442	0,088	0,025	1,456	0,031	2330	4950
VS-156	1,562	1,488	0,118	0,031	1,505	0,039	3200	6390
VS-162	1,625	1,550	0,118	0,031	1,568	0,039	3330	6650
VS-168	1,687	1,612	0,118	0,031	1,630	0,039	3460	6900
VS-175	1,750	1,674	0,118	0,031	1,693	0,039	3590	7160
VS-181	1,812	1,736	0,118	0,031	1,755	0,039	3710	7410
VS-187	1,875	1,798	0,118	0,031	1,818	0,039	3840	7670
VS-193	1,937	1,859	0,118	0,031	1,880	0,039	3970	7920
VS-200	2,000	1,922	0,118	0,031	1,943	0,039	4100	8180
VS-206	2,062	1,963	0,158	0,031	1,986	0,039	5540	8430
VS-212	2,125	2,026	0,158	0,031	2,049	0,039	5710	8690
VS-218	2,187	2,087	0,158	0,031	2,111	0,039	5870	8950
VS-225	2,250	2,149	0,158	0,031	2,174	0,039	6040	9200
VS-231	2,312	2,211	0,158	0,031	2,236	0,039	6210	9460
VS-237	2,375	2,273	0,158	0,031	2,299	0,039	6380	9720
VS-243	2,437	2,335	0,158	0,031	2,361	0,039	6550	9970
VS-250	2,500	2,397	0,158	0,031	2,424	0,039	6720	10230
VS-256	2,562	2,458	0,158	0,031	2,486	0,039	6880	10480
VS-262	2,625	2,521	0,158	0,031	2,549	0,039	7050	10740
VS-268	2,687	2,582	0,158	0,031	2,611	0,039	7220	10990
VS-275	2,750	2,644	0,158	0,031	2,674	0,039	7390	11250
VS-281	2,812	2,706	0,158	0,031	2,736	0,039	7550	11500
VS-287	2,875	2,768	0,158	0,031	2,799	0,039	7720	11760
VS-293	2,937	2,830	0,158	0,031	2,861	0,039	7890	12010
VS-300	3,000	2,892	0,158	0,031	2,924	0,039	8060	12270

¹ Add suffix "-S02" for 302 stainless steel, "-S16" for 316 stainless steel.

² Based on a groove material yield strength of 45,000 psi and a safety factor of 2.

³ Based on a safety factor of 3.

⁴ See pages 134 – 135 for How to Order.

⁵ 1 lb = 4,448 N

1 psi = 0,0069 N/mm²

1 inch = 25,4 mm

Stock Items available in carbon steel and 302 and 316 stainless steel.

Product Dimensions All dimensions in inches unless otherwise specified.

Smalley Part Number ^{1,4}	Shaft Diameter	Ring			Groove		Thrust Capacity	
		Inside Diameter	Radial Wall	Thickness	Diameter	Width	Groove Yield (lb) ²	Ring Shear (lb) ³
VS-306	3,062	2,938	0,188	0,039	2,970	0,044	9960	15760
VS-312	3,125	3,001	0,188	0,039	3,033	0,044	10160	16080
VS-318	3,187	3,062	0,188	0,039	3,095	0,044	10360	16400
VS-325	3,250	3,125	0,188	0,039	3,158	0,044	10570	16720
VS-331	3,312	3,186	0,188	0,039	3,220	0,044	10770	17040
VS-337	3,375	3,248	0,188	0,039	3,283	0,044	10970	17370
VS-343	3,437	3,310	0,188	0,039	3,345	0,044	11180	17690
VS-350	3,500	3,372	0,188	0,039	3,408	0,044	11380	18010
VS-356	3,562	3,433	0,188	0,039	3,470	0,044	11580	18330
VS-362	3,625	3,496	0,188	0,039	3,533	0,044	11790	18650
VS-368	3,687	3,557	0,188	0,039	3,595	0,044	11990	18970
VS-375	3,750	3,620	0,188	0,039	3,658	0,044	12190	19300
VS-381	3,812	3,681	0,188	0,039	3,720	0,044	12400	19620
VS-387	3,875	3,743	0,188	0,039	3,783	0,044	12600	19940
VS-393	3,937	3,805	0,188	0,039	3,845	0,044	12800	20260
VS-400	4,000	3,867	0,188	0,039	3,908	0,044	13010	20580
VS-412	4,125	3,973	0,225	0,046	4,015	0,052	16040	23850
VS-425	4,250	4,097	0,225	0,046	4,140	0,052	16520	24570
VS-437	4,375	4,221	0,225	0,046	4,265	0,052	17010	25290
VS-450	4,500	4,345	0,225	0,046	4,390	0,052	17500	26010
VS-462	4,625	4,468	0,225	0,046	4,515	0,052	17980	26740
VS-475	4,750	4,592	0,225	0,046	4,640	0,052	18470	27460
VS-487	4,875	4,715	0,225	0,046	4,765	0,052	18950	28180
VS-500	5,000	4,839	0,225	0,046	4,890	0,052	19440	28900
VS-525	5,250	5,067	0,225	0,061	5,119	0,067	24490	40240
VS-550	5,500	5,309	0,225	0,061	5,363	0,067	26830	42160
VS-575	5,750	5,550	0,225	0,061	5,606	0,067	29260	44080
VS-600	6,000	5,792	0,225	0,061	5,850	0,067	31810	45990
VS-625	6,250	6,033	0,265	0,061	6,094	0,067	34460	47910
VS-650	6,500	6,275	0,265	0,061	6,338	0,067	37220	49830
VS-675	6,750	6,515	0,265	0,061	6,581	0,067	40560	51740
VS-700	7,000	6,757	0,265	0,061	6,825	0,067	43540	53660
VS-725	7,250	6,998	0,300	0,061	7,069	0,067	46640	55580
VS-750	7,500	7,240	0,300	0,061	7,313	0,067	49830	57490
VS-775	7,750	7,480	0,300	0,061	7,556	0,067	53140	59410
VS-800	8,000	7,722	0,300	0,061	7,800	0,067	56550	61320
VS-825	8,250	7,964	0,345	0,076	8,044	0,082	60070	78790
VS-850	8,500	8,205	0,345	0,076	8,288	0,082	63690	81180
VS-875	8,750	8,446	0,345	0,076	8,531	0,082	68040	83570
VS-900	9,000	8,687	0,345	0,076	8,775	0,082	71890	85950
VS-925	9,250	8,929	0,345	0,076	9,019	0,082	75850	88340
VS-950	9,500	9,170	0,345	0,076	9,263	0,082	79910	90730
VS-975	9,750	9,411	0,345	0,076	9,506	0,082	84080	93120
VS-1000	10,000	9,653	0,345	0,076	9,750	0,082	88360	95500

¹ Add suffix "-S02" for 302 stainless steel, "-S16" for 316 stainless steel.

² Based on a groove material yield strength of 45,000 psi and a safety factor of 2.

³ Based on a safety factor of 3.

⁴ See pages 134 –135 for How to Order.

⁵ 1 lb = 4,448 N

1 psi = 0,0069 N/mm²

1 inch = 25,4 mm

Stock Items available in carbon steel and 302 and 316 stainless steel.

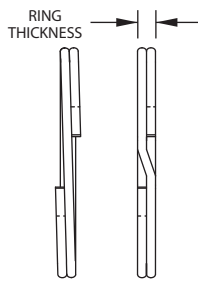
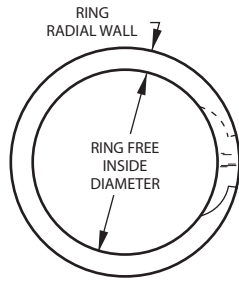
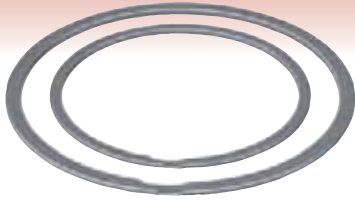

WS-50 / WS-150
WS-156 & UP

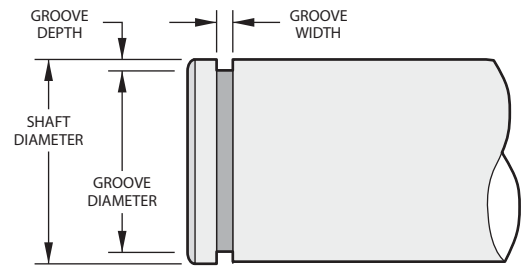

AS3218, AS4299
MIL-DTL-27426/1

Product Dimensions All dimensions in inches unless otherwise specified.

Smalley Part Number ^{1,4}	Shaft Diameter	Ring			Groove		Thrust Capacity	
		Inside Diameter	Radial Wall	Thickness	Diameter	Width	Groove Yield (lb) ²	Ring Shear (lb) ³
WS-50	0,500	0,467	0,045	0,025	0,474	0,030	460	2000
WS-53	0,531	0,498	0,045	0,025	0,505	0,030	490	2130
WS-55	0,551	0,518	0,045	0,025	0,525	±0,002	510	2210
WS-56	0,562	0,529	0,045	0,025	0,536	0,030	520	2250
WS-59	0,594	0,561	0,045	0,025	0,569	0,030	550	2380
WS-62	0,625	0,585	0,055	0,025	0,594	0,030	710	2500
WS-65	0,656	0,617	0,055	0,025	0,625	0,030	740	2630
WS-66	0,669	0,629	0,055	0,025	0,638	0,030	760	2680
WS-68	0,687	0,647	0,055	0,025	0,656	0,030	780	2750
WS-71	0,718	0,679	0,055	0,025	0,687	0,030	810	2880
WS-75	0,750	0,710	0,065	0,031	0,719	0,036	850	3360
WS-78	0,781	0,741	0,065	0,031	0,750	0,036	880	3500
WS-81	0,812	0,771	0,065	0,031	0,781	0,036	920	3640
WS-84	0,843	0,803	0,065	0,031	0,812	±0,003	950	3780
WS-87	0,875	0,828	0,065	0,031	0,838	0,036	1180	3920
WS-90	0,906	0,860	0,065	0,031	0,869	0,036	1220	4060
WS-93	0,937	0,889	0,065	0,031	0,900	0,036	1260	4200
WS-96	0,968	0,916	0,075	0,037	0,925	0,042	1440	5180
WS-98	0,984	0,930	0,075	0,037	0,941	0,042	1460	5260
WS-100	1,000	0,946	0,075	0,037	0,957	0,042	1480	5350
WS-102	1,023	0,968	0,075	0,037	0,980	0,042	1520	5470
WS-103	1,031	0,978	0,075	0,037	0,988	0,042	1530	5510
WS-106	1,062	1,007	0,075	0,037	1,020	0,042	1580	5680
WS-109	1,093	1,040	0,075	0,037	1,051	0,042	1620	5840
WS-112	1,125	1,070	0,075	0,037	1,083	0,042	1670	6020
WS-115	1,156	1,102	0,075	0,037	1,114	0,042	1720	6180
WS-118	1,188	1,127	0,085	0,043	1,140	0,048	2020	7380
WS-121	1,218	1,159	0,085	0,043	1,170	0,048	2070	7570
WS-125	1,250	1,188	0,085	0,043	1,202	0,048	2120	7770
WS-128	1,281	1,221	0,085	0,043	1,233	0,048	2170	7960
WS-131	1,312	1,251	0,095	0,043	1,264	0,048	2230	8150
WS-134	1,343	1,282	0,095	0,043	1,295	0,048	2280	8350
WS-137	1,375	1,308	0,095	0,043	1,323	0,048	2530	8540
WS-140	1,406	1,340	0,095	0,043	1,354	0,048	2580	8740
WS-143	1,437	1,370	0,095	0,043	1,385	0,048	2640	8930
WS-146	1,468	1,402	0,095	0,043	1,416	0,048	2700	9120
WS-150	1,500	1,433	0,095	0,043	1,448	0,048	2760	9320
WS-156	1,562	1,490	0,108	0,049	1,507	0,056	3090	10100
WS-157	1,575	1,503	0,108	0,049	1,520	0,056	3120	10190
WS-162	1,625	1,549	0,108	0,049	1,566	0,056	3450	10510
WS-168	1,687	1,610	0,118	0,049	1,628	0,056	3580	10910
WS-175	1,750	1,673	0,118	0,049	1,691	±0,005	3710	11310
WS-177	1,771	1,690	0,118	0,049	1,708	0,056	4010	11450
WS-181	1,813	1,730	0,118	0,049	1,749	0,056	4100	11720

¹ Add suffix "-S02" for 302 stainless steel, "-S16" for 316 stainless steel.
² Based on a groove material yield strength of 45,000 psi and a safety factor of 2.
³ Based on a safety factor of 3.
⁴ See pages 134 - 135 for How to Order.
⁵ 1 lb = 4,448 N
 1 psi = 0,0069 N/mm²
 1 inch = 25,4 mm

Stock Items available in carbon steel and 302 and 316 stainless steel.

Product Dimensions All dimensions in inches unless otherwise specified.

Smalley Part Number ^{1,4}	Shaft Diameter	Ring			Groove		Thrust Capacity	
		Inside Diameter	Radial Wall	Thickness	Diameter	Width	Groove Yield (lb) ²	Ring Shear (lb) ³
WS-187	1,875	1,789	0,128	0,049	1,808	0,056	4510	12120
WS-193	1,938	1,844	0,128	0,049	1,861	0,056	4660	12530
WS-196	1,969	1,882	0,128	0,049	1,902	0,056	4730	12730
WS-200	2,000	1,909	0,128	0,049	1,929	0,056	4950	12930
WS-206	2,062	1,971	0,128	0,049	1,992	0,056	5100	13330
WS-212	2,125	2,029	0,128	0,049	2,051	0,056	5560	13740
WS-215	2,156	2,060	0,138	0,049	2,082	0,056	5640	13940
WS-216	2,165	2,070	0,138	0,049	2,091	0,056	5660	14000
WS-218	2,188	2,092	0,138	0,049	2,113	0,056	5720	14150
WS-225	2,250	2,153	0,138	0,049	2,176	0,056	5890	14550
WS-231	2,312	2,211	0,138	0,049	2,234	0,056	6370	14950
WS-236	2,362	2,261	0,138	0,049	2,284	0,056	6510	15270
WS-237	2,375	2,273	0,138	0,049	2,297	0,056	6550	15360
WS-243	2,437	2,331	0,148	0,049	2,355	0,056	7060	15760
WS-250	2,500	2,394	0,148	0,049	2,418	0,056	7250	16160
WS-255	2,559	2,449	0,148	0,049	2,473	0,056	7780	16550
WS-256	2,562	2,452	0,148	0,049	2,476	0,056	7790	16560
WS-262	2,625	2,514	0,148	0,049	2,539	0,056	7980	16970
WS-268	2,688	2,572	0,158	0,049	2,597	0,056	8550	17380
WS-275	2,750	2,635	0,158	0,049	2,660	0,056	8750	17780
WS-281	2,813	2,696	0,168	0,049	2,722	0,056	8950	18190
WS-287	2,875	2,755	0,168	0,049	2,781	0,056	9550	18590
WS-293	2,937	2,817	0,168	0,049	2,843	0,056	9760	18990
WS-295	2,952	2,831	0,168	0,049	2,858	0,056	9810	19090
WS-300	3,000	2,877	0,168	0,061	2,904	0,068	10180	24150
WS-306	3,062	2,938	0,168	0,061	2,966	0,068	10390	24650
WS-312	3,125	3,000	0,178	0,061	3,027	0,068	10820	25150
WS-314	3,149	3,023	0,178	0,061	3,051	0,068	10910	25350
WS-318	3,187	3,061	0,178	0,061	3,089	0,068	11040	25650
WS-325	3,250	3,121	0,178	0,061	3,150	0,068	11490	26160
WS-331	3,312	3,180	0,188	0,061	3,208	0,068	12170	26660
WS-334	3,343	3,210	0,188	0,061	3,239	0,068	12290	26910
WS-337	3,375	3,242	0,188	0,061	3,271	0,068	12410	27170
WS-343	3,437	3,301	0,188	0,061	3,331	0,068	12880	27660
WS-350	3,500	3,363	0,188	0,061	3,394	0,068	13110	28170
WS-354	3,543	3,402	0,198	0,061	3,433	0,068	13770	28520
WS-356	3,562	3,422	0,198	0,061	3,452	0,068	13850	28670
WS-362	3,625	3,483	0,198	0,061	3,515	0,068	14090	29180
WS-368	3,687	3,543	0,198	0,061	3,575	0,068	14600	29680
WS-374	3,740	3,597	0,198	0,061	3,628	0,068	14800	30100
WS-375	3,750	3,606	0,198	0,061	3,638	0,068	14840	30180
WS-381	3,812	3,668	0,198	0,061	3,700	0,068	15090	30680
WS-387	3,875	3,724	0,208	0,061	3,757	0,068	16160	31190
WS-393	3,938	3,784	0,208	0,061	3,820	0,068	16420	31700
WS-400	4,000	3,842	0,218	0,061	3,876	0,068	17530	32200
WS-406	4,063	3,906	0,218	0,061	3,939	0,068	17810	32700
WS-412	4,125	3,967	0,218	0,061	4,000	0,068	18080	33200
WS-413	4,134	3,975	0,218	0,061	4,010	0,068	18120	33270
WS-418	4,188	4,030	0,218	0,061	4,058	0,068	19240	33710
WS-425	4,250	4,084	0,228	0,061	4,120	0,068	19530	34210
WS-431	4,312	4,147	0,228	0,061	4,182	0,068	19810	34710
WS-433	4,331	4,164	0,228	0,061	4,200	0,068	19900	34860
WS-437	4,375	4,208	0,228	0,061	4,245	0,068	20100	35210
WS-443	4,437	4,271	0,228	0,061	4,307	0,068	20390	35710
WS-450	4,500	4,326	0,238	0,061	4,364	0,068	21630	36220
WS-456	4,562	4,384	0,250	0,072	4,422	0,079	22570	43340
WS-462	4,625	4,447	0,250	0,072	4,485	0,079	22890	43940
WS-468	4,687	4,508	0,250	0,072	4,547	0,079	23190	44530
WS-472	4,724	4,546	0,250	0,072	4,584	0,079	23370	44880
WS-475	4,750	4,571	0,250	0,072	4,610	0,079	23500	45130
WS-481	4,812	4,633	0,250	0,072	4,672	0,079	23810	45720
WS-487	4,875	4,695	0,250	0,072	4,735	0,079	24120	46310

¹ Add suffix "-S02" for 302 stainless steel, "-S16" for 316 stainless steel.

² Based on a groove material yield strength of 45,000 psi and a safety factor of 2.

³ Based on a safety factor of 3.

⁴ See pages 134-135 for How to Order.

⁵ 1 lb = 4,448 N

1 psi = 0,0069 N/mm²

1 inch = 25,4 mm

Stock Items available in carbon steel and 302 and 316 stainless steel.

Product Dimensions All dimensions in inches unless otherwise specified.

Smalley Part Number ^{1,4}	Shaft Diameter	Ring			Groove		Thrust Capacity	
		Inside Diameter	Radial Wall	Thickness	Diameter	Width	Groove Yield (lb) ²	Ring Shear (lb) ³
WS-493	4,937	4,757	0,250	0,072	4,797	0,079	24430	46900
WS-500	5,000	4,820	0,250	0,072	4,856	0,079	25450	47500
WS-511	5,118	4,934	0,250	0,072	4,974	0,079	26050	48620
WS-512	5,125	4,939	0,250	0,072	4,981	0,079	26080	48690
WS-525	5,250	5,064	0,250	0,072	5,107	0,079	26720	49880
WS-537	5,375	5,187	0,250	0,072	5,228	0,079	28120	51060
WS-550	5,500	5,308	0,250	0,072	5,353	0,079	28770	52250
WS-551	5,511	5,320	0,250	0,072	5,364	0,079	28830	52360
WS-562	5,625	5,433	0,250	0,072	5,478	0,079	29420	53440
WS-575	5,750	5,550	0,250	0,072	5,597	0,079	31300	54630
WS-587	5,875	5,674	0,250	0,072	5,722	0,079	31980	55810
WS-590	5,905	5,705	0,250	0,072	5,752	0,079	32140	56100
WS-600	6,000	5,798	0,250	0,072	5,847	0,079	32660	57000
WS-612	6,125	5,903	0,312	0,086	5,953	0,094	37230	69500
WS-625	6,250	6,026	0,312	0,086	6,078	0,094	37990	70920
WS-629	6,299	6,076	0,312	0,086	6,127	0,094	38290	71480
WS-637	6,375	6,152	0,312	0,086	6,203	0,094	38750	72340
WS-650	6,500	6,274	0,312	0,086	6,328	0,094	39510	73760
WS-662	6,625	6,390	0,312	0,086	6,443	0,094	42620	75180
WS-675	6,750	6,513	0,312	0,086	6,568	0,094	43420	76600
WS-687	6,875	6,638	0,312	0,086	6,693	0,094	44220	78010
WS-700	7,000	6,761	0,312	0,086	6,818	0,094	45030	79430
WS-712	7,125	6,877	0,312	0,086	6,933	0,094	48350	80850
WS-725	7,250	6,999	0,312	0,086	7,058	0,094	49200	82270
WS-737	7,375	7,125	0,312	0,086	7,183	0,094	50050	83690
WS-750	7,500	7,250	0,312	0,086	7,308	0,094	50890	85110
WS-762	7,625	7,363	0,312	0,086	7,423	0,094	54440	86520
WS-775	7,750	7,486	0,312	0,086	7,548	0,094	55330	87940
WS-787	7,875	7,611	0,312	0,086	7,673	0,094	56220	89360
WS-800	8,000	7,734	0,312	0,086	7,798	0,094	57110	90780
WS-825	8,250	7,972	0,375	0,086	8,038	0,094	61820	93620
WS-850	8,500	8,220	0,375	0,086	8,288	0,094	63690	96450
WS-875	8,750	8,459	0,375	0,086	8,528	0,094	68650	99290
WS-900	9,000	8,707	0,375	0,086	8,778	0,094	70620	102130
WS-925	9,250	8,945	0,375	0,086	9,018	0,094	75850	104960
WS-950	9,500	9,194	0,375	0,086	9,268	0,094	77900	107800
WS-975	9,750	9,432	0,375	0,086	9,508	0,094	83390	110640
WS-1000	10,000	9,680	0,375	0,086	9,758	0,094	85530	113470
WS-1025	10,250	9,918	0,375	0,086	9,998	0,094	91290	116310
WS-1050	10,500	10,166	0,375	0,086	10,248	0,094	93520	119150
WS-1075	10,750	10,405	0,375	0,086	10,488	0,094	99540	121990
WS-1100	11,000	10,653	0,375	0,086	10,738	0,094	101860	124820

¹ Add suffix "-S02" for 302 stainless steel, "-S16" for 316 stainless steel.

² Based on a groove material yield strength of 45,000 psi and a safety factor of 2.

³ Based on a safety factor of 3.

⁴ See pages 134 – 135 for How to Order.

⁵ 1 lb = 4,448 N

1 psi = 0,0069 N/mm²

1 inch = 25,4 mm

Stock Items available in carbon steel and 17-7 PH stainless steel.

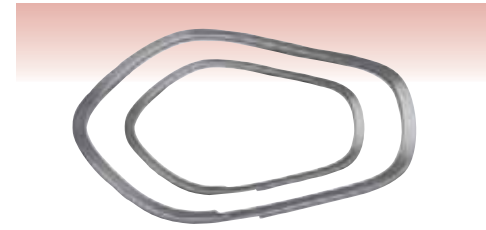
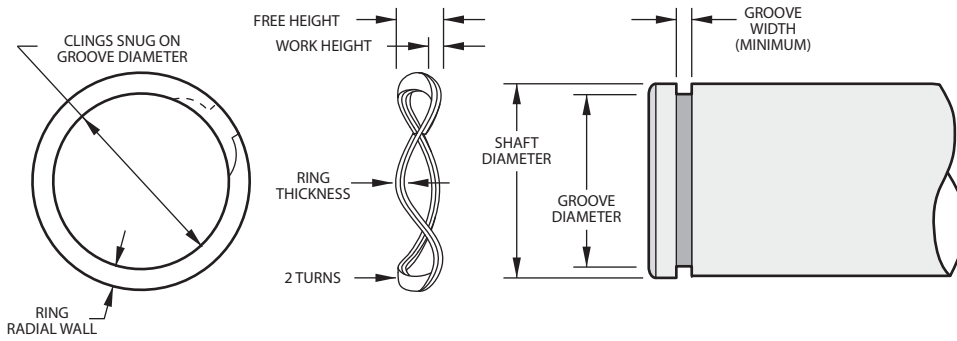

Product Dimensions All dimensions in inches unless otherwise specified.

Smalley Part Number ^{1,2}	Shaft Diameter	Load (lb) @ Work Height	Max. Free Height	Number of Waves	Ring			Groove	
					Thickness	Radial Wall	Crimp	Diameter	Width Min.
WSW-75	0,750	25 @ 0,085	0,115	3	0,042	0,065	N	0,704	0,120
WSW-87	0,875	30 @ 0,085	0,131	3	0,042	0,075	N	0,821	0,136
WSW-100	1,000	34 @ 0,085	0,129	3	0,042	0,085	N	0,940	0,134
WSW-112	1,125	38 @ 0,100	0,137	3	0,050	0,128	N	1,059	0,142
WSW-125	1,250	40 @ 0,100	0,145	3	0,050	0,128	N	1,176	0,150
WSW-137	1,375	45 @ 0,100	0,130	4	0,050	0,128	N	1,291	0,135
WSW-150	1,500	50 @ 0,100	0,126	4	0,050	0,128	N	1,406	0,131
WSW-162	1,625	55 @ 0,110	0,138	4	0,062	0,158	N	1,529	0,143
WSW-175	1,750	60 @ 0,110	0,137	4	0,062	0,158	N	1,650	0,142
WSW-187	1,875	63 @ 0,110	0,140	4	0,062	0,158	N	1,769	0,145
WSW-200	2,000	65 @ 0,110	0,145	4	0,062	0,158	N	1,886	0,150
WSW-212	2,125	70 @ 0,130	0,170	4	0,078	0,188	N	2,003	0,175
WSW-225	2,250	75 @ 0,130	0,175	4	0,078	0,188	N	2,120	0,180
WSW-237	2,375	80 @ 0,130	0,175	4	0,078	0,188	N	2,239	0,180
WSW-250	2,500	84 @ 0,130	0,171	4	0,078	0,188	N	2,360	0,176
WSW-262	2,625	88 @ 0,130	0,181	4	0,078	0,188	N	2,481	0,190
WSW-275	2,750	94 @ 0,170	0,217	4	0,093	0,225	Y	2,602	0,222
WSW-287	2,875	97 @ 0,170	0,217	4	0,093	0,225	Y	2,721	0,222
WSW-300	3,000	100 @ 0,170	0,225	4	0,093	0,225	Y	2,838	0,230
WSW-312	3,125	103 @ 0,170	0,230	4	0,093	0,225	Y	2,957	0,235
WSW-325	3,250	106 @ 0,170	0,225	4	0,093	0,225	Y	3,076	0,230
WSW-350	3,500	115 @ 0,185	0,245	4	0,111	0,281	Y	3,316	0,250
WSW-362	3,625	117 @ 0,185	0,250	4	0,111	0,281	Y	3,435	0,255
WSW-375	3,750	121 @ 0,185	0,258	4	0,111	0,281	Y	3,552	0,263
WSW-387	3,875	126 @ 0,185	0,255	4	0,111	0,281	Y	3,673	0,260
WSW-400	4,000	130 @ 0,185	0,268	4	0,111	0,281	Y	3,792	0,273
WSW-412	4,125	134 @ 0,185	0,263	4	0,111	0,281	Y	3,919	0,268
WSW-425	4,250	140 @ 0,185	0,248	5	0,111	0,281	Y	4,065	0,253
WSW-450	4,500	150 @ 0,185	0,256	5	0,111	0,281	Y	4,310	0,261
WSW-475	4,750	160 @ 0,185	0,253	5	0,111	0,281	Y	4,550	0,258
WSW-500	5,000	170 @ 0,185	0,259	5	0,111	0,281	Y	4,790	0,264

¹ Add suffix "-S17" for stainless steel.

² See pages 134 –135 for How to Order.

³ 1 lb = 4,448 N

1 psi = 0,0069 N/mm²

1 inch = 25,4 mm

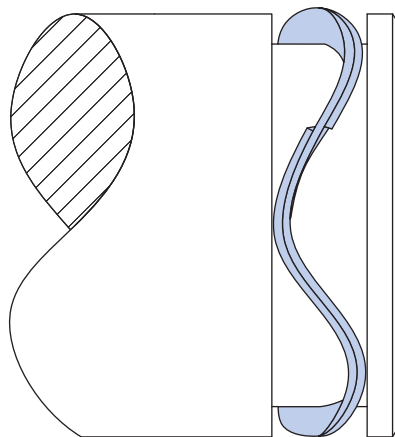

Stock Items available in carbon steel and 302 and 316 stainless steel.

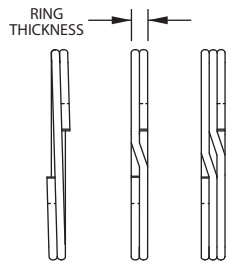
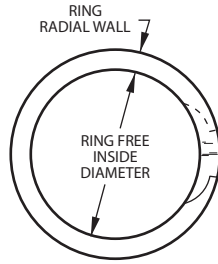
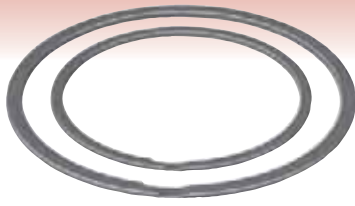

WST-46 / WS-150 WST-156 / WST-600 WST-625 & UP

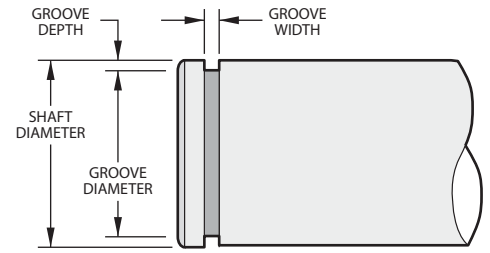

Product Dimensions All dimensions in inches unless otherwise specified.

Smalley Part Number ^{1,4}	Shaft Diameter	Ring			Groove		Thrust Capacity	
		Inside Diameter	Radial Wall	Thickness	Diameter	Width	Groove Yield (lb) ²	Ring Shear (lb) ³
WST-46	0,469	0,436	0,045	0,025	0,443	0,029	430	1800
WST-50	0,500	0,469	0,045	0,035	0,474	0,039	460	2530
WST-55	0,551	0,518	0,045	0,035	0,524	0,039	550	2790
WST-56	0,562	0,529	0,045	0,035	0,535	0,039	560	2840
WST-59	0,594	0,559	0,045	0,035	0,565	0,039	630	3000
WST-62	0,625	0,590	0,055	0,035	0,596	0,039	660	3160
WST-66	0,669	0,630	0,055	0,035	0,638	0,039	760	3380
WST-68	0,688	0,648	0,065	0,042	0,655	0,046	830	4180
WST-75	0,750	0,708	0,065	0,042	0,715	0,046	950	4550
WST-78	0,781	0,738	0,065	0,042	0,745	0,046	990	4740
WST-81	0,812	0,768	0,065	0,042	0,776	0,046	1030	4930
WST-87	0,875	0,827	0,075	0,042	0,835	0,046	1240	5310
WST-93	0,938	0,886	0,075	0,042	0,894	0,046	1460	5690
WST-98	0,984	0,934	0,075	0,042	0,940	0,046	1530	5970
WST-100	1,000	0,947	0,075	0,042	0,955	0,046	1630	6070
WST-102	1,023	0,969	0,075	0,042	0,977	0,046	1660	6210
WST-106	1,062	1,005	0,088	0,050	1,015	0,056	1800	7010
WST-112	1,125	1,064	0,088	0,050	1,075	0,056	1990	7420
WST-118	1,188	1,126	0,088	0,050	1,135	0,056	2270	7370
WST-125	1,250	1,184	0,093	0,050	1,195	0,056	2470	8250
WST-131	1,312	1,240	0,098	0,050	1,250	0,056	2880	8660
WST-137	1,375	1,298	0,103	0,050	1,310	0,056	3210	9070
WST-143	1,438	1,359	0,103	0,050	1,370	0,056	3460	9490
WST-150	1,500	1,419	0,103	0,050	1,430	0,056	3710	9900
WST-156	1,562	1,476	0,113	0,062	1,490	0,068	3980	12780
WST-162	1,625	1,537	0,118	0,062	1,550	0,068	4370	13290
WST-168	1,687	1,598	0,118	0,062	1,610	0,068	4650	13800
WST-175	1,750	1,657	0,118	0,062	1,670	0,068	4950	14320
WST-177	1,771	1,676	0,123	0,062	1,689	0,068	5130	14490
WST-181	1,812	1,714	0,123	0,062	1,730	0,068	5250	14820
WST-187	1,875	1,774	0,123	0,062	1,790	0,068	5700	15340
WST-196	1,969	1,864	0,123	0,062	1,879	0,068	6260	16110
WST-200	2,000	1,894	0,128	0,062	1,910	0,068	6360	16360
WST-206	2,062	1,955	0,141	0,078	1,970	0,086	6710	21220
WST-212	2,125	2,012	0,141	0,078	2,027	0,086	7360	21870
WST-215	2,156	2,041	0,141	0,078	2,057	0,086	7620	22190
WST-225	2,250	2,129	0,141	0,078	2,145	0,086	8430	23160
WST-231	2,312	2,188	0,141	0,078	2,205	0,086	8830	23800
WST-237	2,375	2,248	0,141	0,078	2,265	0,086	9230	24440
WST-243	2,437	2,307	0,141	0,078	2,325	0,086	9650	25080
WST-250	2,500	2,366	0,188	0,078	2,385	0,086	10250	25730
WST-255	2,559	2,424	0,188	0,078	2,443	0,086	10490	26340
WST-262	2,625	2,485	0,188	0,078	2,505	0,086	11130	27020
WST-268	2,687	2,545	0,188	0,078	2,565	0,086	11590	27660

¹ Add suffix "-S02" for 302 stainless steel, "-S16" for 316 stainless steel.

² Based on a groove material yield strength of 45,000 psi and a safety factor of 2.

³ Based on a safety factor of 3.

⁴ See pages 134 - 135 for How to Order.

⁵ 1 lb = 4,448 N

1 psi = 0,0069 N/mm²

1 inch = 25,4 mm

Smalley Part Number ^{1,4}	Shaft Diameter	Ring			Groove		Thrust Capacity	
		Inside Diameter	Radial Wall	Thickness	Diameter	Width	Groove Yield (lb) ²	Ring Shear (lb) ³
WST-275	2,750	2,604	0,188	0,093	2,625	0,103	12250	32140
WST-287	2,875	2,722	0,188	0,093	2,742	0,103	13620	33600
WST-293	2,937	2,780	0,188	0,093	2,801	0,103	14120	34320
WST-300	3,000	2,838	0,188	0,093	2,860	0,103	14840	35060
WST-306	3,062	2,897	0,188	0,093	2,920	0,103	15370	35790
WST-312	3,125	2,957	0,188	0,093	2,980	0,103	16130	36520
WST-315	3,156	2,986	0,188	0,093	3,010	0,103	16290	36880
WST-325	3,250	3,075	0,188	0,093	3,100	0,103	17230	37980
WST-334	3,344	3,164	0,188	0,093	3,190	0,103	18200	39080
WST-343	3,437	3,254	0,188	0,093	3,280	0,103	19190	40170
WST-350	3,500	3,315	0,250	0,111	3,340	0,120	19790	48820
WST-354	3,543	3,356	0,250	0,111	3,381	0,120	20290	49420
WST-362	3,625	3,433	0,250	0,111	3,458	0,120	21520	50560
WST-368	3,687	3,490	0,250	0,111	3,517	0,120	22150	51430
WST-375	3,750	3,550	0,250	0,111	3,577	0,120	23060	52310
WST-387	3,875	3,670	0,250	0,111	3,696	0,120	24650	54050
WST-393	3,938	3,730	0,250	0,111	3,756	0,120	25330	54930
WST-400	4,000	3,787	0,250	0,111	3,815	0,120	26300	55800
WST-425	4,250	4,032	0,250	0,111	4,065	0,120	27940	59280
WST-437	4,375	4,162	0,250	0,111	4,190	0,120	28760	61030
WST-450	4,500	4,280	0,250	0,111	4,310	0,120	30220	62770
WST-475	4,750	4,515	0,250	0,111	4,550	0,120	33580	66260
WST-500	5,000	4,755	0,250	0,111	4,790	0,120	37110	69740
WST-525	5,250	4,995	0,375	0,127	5,030	0,139	40820	83790
WST-550	5,500	5,229	0,375	0,127	5,265	0,139	45880	87780
WST-575	5,750	5,466	0,375	0,127	5,505	0,139	49990	91770
WST-600	6,000	5,705	0,375	0,127	5,745	0,139	54290	95760

¹ Add suffix "-S02" for 302 stainless steel, "-S16" for 316 stainless steel.

² Based on a groove material yield strength of 45,000 psi and a safety factor of 2.

³ Based on a safety factor of 3.

⁴ See pages 134 –135 for How to Order.

⁵ 1 lb = 4,448 N

1 psi = 0,0069 N/mm²

1 inch = 25,4 mm

Rings listed below are three-turn construction.

Smalley Part Number ^{1,4}	Shaft Diameter	Ring			Groove		Thrust Capacity	
		Inside Diameter	Radial Wall	Thickness	Diameter	Width	Groove Yield (lb) ²	Ring Shear (lb) ³
WST-625	6,250	5,942	0,312	0,165	5,985	0,174	58760	129590
WST-650	6,500	6,182	0,312	0,165	6,225	0,174	63410	134780
WST-675	6,750	6,420	0,312	0,165	6,465	0,174	68230	139960
WST-700	7,000	6,658	0,312	0,165	6,705	0,174	73230	145140
WST-725	7,250	6,894	0,312	0,165	6,942	0,174	78290	172190
WST-750	7,500	7,130	0,375	0,189	7,180	0,209	84820	178130
WST-775	7,750	7,368	0,375	0,189	7,420	0,209	90390	184070
WST-800	8,000	7,607	0,375	0,189	7,660	0,209	96130	190000
WST-825	8,250	7,845	0,375	0,189	7,900	0,209	102050	195940
WST-850	8,500	8,083	0,375	0,189	8,140	0,209	108150	201880
WST-875	8,750	8,321	0,375	0,189	8,383	0,209	113800	207820
WST-900	9,000	8,560	0,375	0,189	8,620	0,209	120870	213750
WST-925	9,250	8,798	0,375	0,189	8,860	0,209	127500	219690
WST-950	9,500	9,036	0,375	0,189	9,100	0,209	134300	225630
WST-975	9,750	9,273	0,375	0,189	9,338	0,209	141970	231570
WST-1000	10,000	9,508	0,375	0,189	9,575	0,209	150560	237500

¹ Add suffix "-S02" for 302 stainless steel, "-S16" for 316 stainless steel.

² Based on a groove material yield strength of 45,000 psi and a safety factor of 2.

³ Based on a safety factor of 3.

⁴ See pages 134 –135 for How to Order.

⁵ 1 lb = 4,448 N

1 psi = 0,0069 N/mm²

1 inch = 25,4 mm

Stock Items available in carbon steel and 302 and 316 stainless steel.

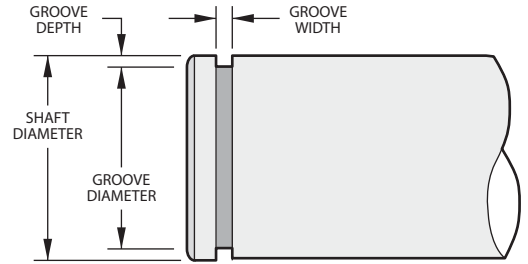
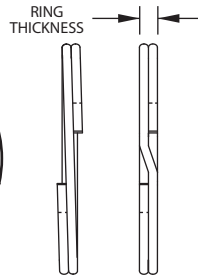
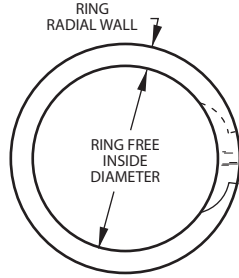
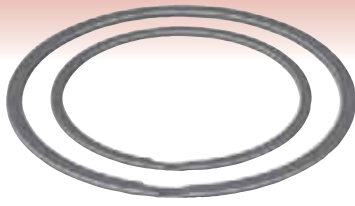

AS3216, AS4299
MIL-DTL-27426/2

Product Dimensions All dimensions in inches unless otherwise specified.

Smalley Part Number ^{1,4}	Shaft Diameter	Ring			Groove		Thrust Capacity	
		Inside Diameter	Radial Wall	Thickness	Diameter	Width	Groove Yield (lb) ²	Ring Shear (lb) ³
WSM-25*	0,250	0,228	0,020	0,025	0,230	0,029	177	961
WSM-31*	0,312	0,287	0,025	0,025	0,290	0,029	243	1200
WSM-37*	0,375	0,349	0,030	0,025	0,352	0,029	305	1442
WSM-43	0,437	0,409	0,035	0,025	0,412	0,029	386	1680
WSM-46	0,469	0,439	0,045	0,025	0,443	0,029	430	1880
WSM-50	0,500	0,464	0,050	0,035	0,468	0,039	570	2530
WSM-55	0,551	0,514	0,050	0,035	0,519	0,039	620	2790
WSM-56	0,562	0,525	0,050	0,035	0,530	0,039	640	2840
WSM-59	0,594	0,554	0,050	0,035	0,559	0,039	760	3000
WSM-62	0,625	0,583	0,055	0,035	0,588	0,039	840	3160
WSM-66	0,669	0,623	0,055	0,035	0,629	0,039	950	3380
WSM-68	0,688	0,641	0,065	0,042	0,646	0,046	1020	4180
WSM-75	0,750	0,698	0,065	0,042	0,704	0,046	1220	4550
WSM-78	0,781	0,727	0,065	0,042	0,733	0,046	1330	4740
WSM-81	0,812	0,756	0,065	0,042	0,762	0,046	1440	4930
WSM-87	0,875	0,814	0,075	0,042	0,821	0,046	1670	5310
WSM-93	0,938	0,875	0,075	0,042	0,882	0,046	1860	5690
WSM-98	0,984	0,919	0,085	0,042	0,926	0,046	2020	5970
WSM-100	1,000	0,932	0,085	0,042	0,940	0,046	2120	6070
WSM-102	1,023	0,953	0,085	0,042	0,961	0,046	2240	6210
WSM-106	1,062	0,986	0,103	0,050	0,998	0,056	2400	7010
WSM-112	1,125	1,047	0,103	0,050	1,059	0,056	2620	7420
WSM-118	1,188	1,105	0,103	0,050	1,118	0,056	2940	7840
WSM-125	1,250	1,163	0,103	0,050	1,176	0,056	3270	8250
WSM-131	1,312	1,218	0,118	0,050	1,232	0,056	3710	8660
WSM-137	1,375	1,277	0,118	0,050	1,291	0,056	4080	9070
WSM-143	1,438	1,336	0,118	0,050	1,350	0,056	4470	9490
WSM-150	1,500	1,385	0,118	0,050	1,406	0,056	4980	9900
WSM-156	1,562	1,453	0,128	0,062	1,468	0,068	5190	12780
WSM-162	1,625	1,513	0,128	0,062	1,529	0,068	5510	13290
WSM-168	1,687	1,573	0,128	0,062	1,589	0,068	5840	13800
WSM-175	1,750	1,633	0,128	0,062	1,650	0,068	6190	14320
WSM-177	1,771	1,651	0,128	0,062	1,669	0,068	6380	14490
WSM-181	1,812	1,690	0,128	0,062	1,708	0,068	6660	14820
WSM-187	1,875	1,751	0,158	0,062	1,769	0,068	7020	15340
WSM-196	1,969	1,838	0,158	0,062	1,857	0,068	7790	16110
WSM-200	2,000	1,867	0,158	0,062	1,886	0,068	8060	16360
WSM-206	2,062	1,932	0,168	0,078	1,946	0,086	8450	21220
WSM-212	2,125	1,989	0,168	0,078	2,003	0,086	9160	21870
WSM-215	2,156	2,018	0,168	0,078	2,032	0,086	9450	22190
WSM-225	2,250	2,105	0,168	0,078	2,120	0,086	10340	23160
WSM-231	2,312	2,163	0,168	0,078	2,178	0,086	10950	23800
WSM-237	2,375	2,223	0,200	0,078	2,239	0,086	11420	24440
WSM-243	2,437	2,283	0,200	0,078	2,299	0,086	11890	25080
WSM-250	2,500	2,343	0,200	0,078	2,360	0,086	12370	25730
WSM-255	2,559	2,402	0,200	0,078	2,419	0,086	12660	26340
WSM-262	2,625	2,464	0,200	0,078	2,481	0,086	13360	27020
WSM-268	2,687	2,523	0,200	0,078	2,541	0,086	13870	27660

¹ Add suffix "-S02" for 302 stainless steel, "-S16" for 316 stainless steel.

² Based on a groove material yield strength of 45,000 psi and a safety factor of 2.

³ Based on a safety factor of 3.

⁴ See pages 134 -135 for How to Order.

⁵ 1 lb = 4,448 N
1 psi = 0,0069 N/mm²
1 inch = 25,4 mm

Stock Items available in carbon steel and 302 and 316 stainless steel.

Product Dimensions All dimensions in inches unless otherwise specified.

Smalley Part Number ^{1,4}	Shaft Diameter	Ring			Groove		Thrust Capacity	
		Inside Diameter	Radial Wall	Thickness	Diameter	Width	Groove Yield (lb) ²	Ring Shear (lb) ³
WSM-275	2,750	2,584	0,225	0,093	2,602	0,103	14390	32140
WSM-287	2,875	2,702	0,225	0,093	2,721	0,103	15650	33600
WSM-293	2,937	2,760	0,225	0,093	2,779	0,103	16400	34320
WSM-300	3,000	2,818	0,225	0,093	2,838	0,103	17180	35060
WSM-306	3,062	2,878	0,225	0,093	2,898	0,103	17750	35790
WSM-312	3,125	2,936	0,225	0,093	2,957	0,103	18560	36520
WSM-315	3,156	2,965	0,225	0,093	2,986	0,103	18960	36880
WSM-325	3,250	3,054	0,225	0,093	3,076	0,103	19990	37980
WSM-334	3,344	3,144	0,225	0,093	3,166	0,103	21040	39080
WSM-343	3,437	3,234	0,225	0,093	3,257	0,103	21870	40170
WSM-350	3,500	3,293	0,270	0,111	3,316	0,120	22760	48820
WSM-354	3,543	3,333	0,270	0,111	3,357	0,120	23290	49420
WSM-362	3,625	3,411	0,270	0,111	3,435	0,120	24340	50560
WSM-368	3,687	3,469	0,270	0,111	3,493	0,120	25280	51430
WSM-375	3,750	3,527	0,270	0,111	3,552	0,120	26240	52310
WSM-387	3,875	3,647	0,270	0,111	3,673	0,120	27670	54050
WSM-393	3,938	3,708	0,270	0,111	3,734	0,120	28390	54930
WSM-400	4,000	3,765	0,270	0,111	3,792	0,120	29410	55800
WSM-425	4,250	4,037	0,270	0,111	4,065	0,120	27940	59280
WSM-437	4,375	4,161	0,270	0,111	4,190	0,120	28760	61030
WSM-450	4,500	4,280	0,270	0,111	4,310	0,120	30220	62770
WSM-475	4,750	4,518	0,270	0,111	4,550	0,120	36930	66260
WSM-500	5,000	4,756	0,270	0,111	4,790	0,120	37110	69740
WSM-525	5,250	4,995	0,350	0,127	5,030	0,139	40820	83790
WSM-550	5,500	5,228	0,350	0,127	5,265	0,139	45880	87780
WSM-575	5,750	5,466	0,350	0,127	5,505	0,139	49990	91770
WSM-600	6,000	5,705	0,350	0,127	5,745	0,139	54290	95760
WSM-625	6,250	5,938	0,418	0,156	5,985	0,174	58760	122520
WSM-650	6,500	6,181	0,418	0,156	6,225	0,174	63410	127420
WSM-675	6,750	6,410	0,418	0,156	6,465	0,174	68230	132330
WSM-700	7,000	6,648	0,418	0,156	6,705	0,174	73230	137230
WSM-725	7,250	6,891	0,418	0,156	6,942	0,174	78920	142130
WSM-750	7,500	7,130	0,437	0,187	7,180	0,209	84820	176240
WSM-775	7,750	7,368	0,437	0,187	7,420	0,209	90390	182120
WSM-800	8,000	7,606	0,437	0,187	7,660	0,209	96130	187990
WSM-825	8,250	7,845	0,437	0,187	7,900	0,209	102050	193870
WSM-850	8,500	8,083	0,437	0,187	8,140	0,209	108150	199740
WSM-875	8,750	8,324	0,437	0,187	8,383	0,209	113800	205620
WSM-900	9,000	8,560	0,500	0,187	8,620	0,209	120870	211490
WSM-925	9,250	8,798	0,500	0,187	8,860	0,209	127500	217370
WSM-950	9,500	9,036	0,500	0,187	9,100	0,209	134300	223240
WSM-975	9,750	9,275	0,500	0,187	9,338	0,209	141970	229120
WSM-1000	10,000	9,508	0,500	0,187	9,575	0,209	150560	234990
WSM-1025	10,250	9,745	0,500	0,187	9,814	0,209	157950	240870
WSM-1050	10,500	9,984	0,500	0,187	10,054	0,209	165510	246740
WSM-1075	10,750	10,221	0,500	0,187	10,293	0,209	174010	252620
WSM-1100	11,000	10,459	0,500	0,187	10,533	0,209	181950	258490
WSM-1125	11,250	10,692	0,500	0,187	10,772	0,209	190060	264360
WSM-1150	11,500	10,934	0,562	0,187	11,011	0,209	199160	270240
WSM-1175	11,750	11,171	0,562	0,187	11,250	0,209	207640	276120
WSM-1200	12,000	11,410	0,562	0,187	11,490	0,209	216300	281990
WSM-1225	12,250	11,647	0,562	0,187	11,729	0,209	226000	287860
WSM-1250	12,500	11,885	0,562	0,187	11,969	0,209	235030	293740
WSM-1275	12,750	12,124	0,562	0,187	12,208	0,209	244240	299610
WSM-1300	13,000	12,361	0,662	0,187	12,448	0,209	253620	305490
WSM-1325	13,250	12,598	0,662	0,187	12,687	0,209	264120	311360
WSM-1350	13,500	12,837	0,662	0,187	12,927	0,209	273870	317240
WSM-1375	13,750	13,074	0,662	0,187	13,166	0,209	283800	323110
WSM-1400	14,000	13,311	0,662	0,187	13,405	0,209	294900	328990
WSM-1425	14,250	13,548	0,662	0,187	13,644	0,209	305200	334860
WSM-1450	14,500	13,787	0,750	0,187	13,884	0,209	315680	340740
WSM-1475	14,750	14,024	0,750	0,187	14,123	0,209	327380	346610
WSM-1500	15,000	14,262	0,750	0,187	14,363	0,209	338230	352490

¹ Add suffix "-S02" for 302 stainless steel, "-S16" for 316 stainless steel.

² Based on a groove material yield strength of 45,000 psi and a safety factor of 2.

³ Based on a safety factor of 3.

⁴ See pages 134 – 135 for How to Order.

⁵ 1 lb = 4,448 N

1 psi = 0,0069 N/mm²

1 inch = 25,4 mm

Stock Items available in carbon steel and 302 stainless steel.

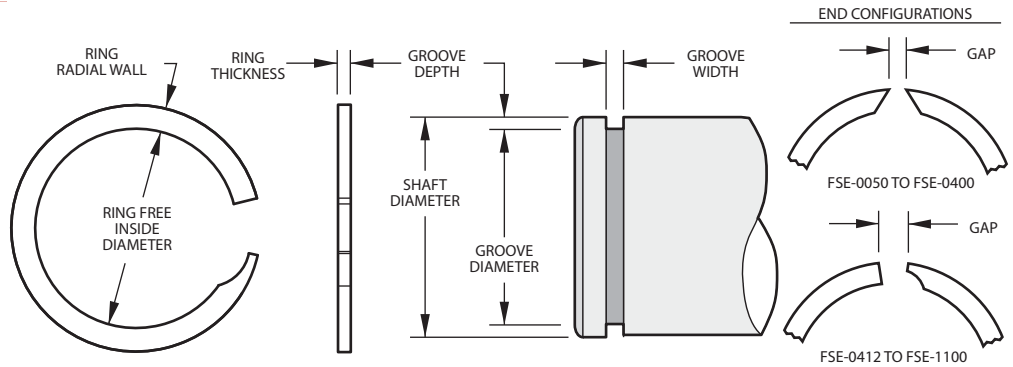

Product Dimensions All dimensions in inches unless otherwise specified.

Smalley Part Number ^{1,4}	Shaft Diameter	Ring			Groove		Thrust Capacity	
		Inside Diameter	Radial Wall	Thickness	Diameter	Width	Groove Yield (lb) ²	Ring Shear (lb) ³
FSE-0050	0,500	0,471	0,055	0,037	0,476	0,043	424	2325
FSE-0056	0,562	0,524	0,055	0,037	0,532	0,043	596	2613
FSE-0062	0,625	0,590	0,065	0,037	0,595	0,043	663	2906
FSE-0068	0,687	0,649	0,065	0,037	0,655	0,043	777	3194
FSE-0075	0,750	0,701	0,075	0,045	0,710	0,051	1060	4241
FSE-0081	0,812	0,764	0,075	0,045	0,772	0,051	1148	4592
FSE-0087	0,875	0,820	0,075	0,045	0,831	0,051	1361	4948
FSE-0093	0,937	0,886	0,085	0,045	0,893	0,051	1457	5334
FSE-0100	1,000	0,933	0,085	0,045	0,952	0,051	1696	5693
FSE-0106	1,062	1,004	0,085	0,045	1,014	0,051	1802	6045
FSE-0112	1,125	1,069	0,128	0,057	1,077	0,063	1909	7615
FSE-0118	1,187	1,116	0,128	0,057	1,131	0,063	2349	8035
FSE-0125	1,250	1,176	0,128	0,057	1,188	0,063	2739	8461
FSE-0131	1,312	1,223	0,128	0,057	1,242	0,063	3246	8881
FSE-0137	1,375	1,282	0,128	0,057	1,297	0,063	3791	9307
FSE-0143	1,437	1,344	0,158	0,067	1,359	0,073	3961	11408
FSE-0150	1,500	1,402	0,158	0,067	1,422	0,073	4135	11908
FSE-0156	1,562	1,457	0,158	0,067	1,470	0,073	5079	12400
FSE-0162	1,625	1,517	0,158	0,067	1,533	0,073	5284	12901
FSE-0168	1,687	1,578	0,158	0,067	1,595	0,073	5485	13393
FSE-0175	1,750	1,640	0,158	0,067	1,658	0,073	5690	13893
FSE-0181	1,812	1,697	0,158	0,067	1,720	0,073	5892	14385
FSE-0187	1,875	1,767	0,158	0,067	1,783	0,073	6097	14885
FSE-0193	1,937	1,800	0,200	0,076	1,819	0,085	8078	16649
FSE-0200	2,000	1,862	0,200	0,076	1,882	0,085	8341	17191
FSE-0206	2,062	1,924	0,200	0,076	1,944	0,085	8599	17724
FSE-0212	2,125	1,987	0,200	0,076	2,007	0,085	8862	18265
FSE-0218	2,187	2,048	0,200	0,076	2,069	0,085	9121	18798
FSE-0225	2,250	2,110	0,200	0,076	2,132	0,085	9384	19340
FSE-0231	2,312	2,171	0,200	0,076	2,194	0,085	9642	19873
FSE-0237	2,375	2,226	0,200	0,076	2,257	0,085	9905	20414
FSE-0243	2,437	2,296	0,200	0,076	2,319	0,085	10163	20947
FSE-0250	2,500	2,357	0,200	0,076	2,382	0,085	10426	21488
FSE-0256	2,562	2,415	0,200	0,095	2,444	0,104	10685	26252
FSE-0262	2,625	2,486	0,200	0,095	2,507	0,104	10947	26898
FSE-0268	2,687	2,537	0,200	0,095	2,569	0,104	11206	27533
FSE-0275	2,750	2,607	0,200	0,095	2,632	0,104	11469	28179
FSE-0281	2,812	2,665	0,200	0,095	2,694	0,104	11727	28814
FSE-0287	2,875	2,727	0,200	0,095	2,757	0,104	11990	29460
FSE-0293	2,937	2,789	0,200	0,095	2,819	0,104	12249	30095

¹ Add suffix "-S02" for 302 stainless steel.

² Based on a groove material yield strength of 45,000 psi and a safety factor of 2.

³ Based on a safety factor of 3.

⁴ See pages 134 - 135 for How to Order.

⁵ 1 lb = 4,448 N

1 psi = 0,0069 N/mm²

1 inch = 25,4 mm

Stock Items available in carbon steel and 302 stainless steel.

Product Dimensions All dimensions in inches unless otherwise specified.

Smalley Part Number ^{1,4}	Shaft Diameter	Ring			Groove		Thrust Capacity	
		Inside Diameter	Radial Wall	Thickness	Diameter	Width	Groove Yield (lb) ²	Ring Shear (lb) ³
FSE-0300	3,000	2,852	0,200	0,095	2,882	0,104	12511	30740
FSE-0306	3,062	2,916	0,200	0,095	2,944	0,104	12770	31376
FSE-0312	3,125	2,955	0,237	0,095	2,987	0,104	15242	32021
FSE-0318	3,187	3,016	0,237	0,095	3,049	0,104	15544	32657
FSE-0325	3,250	3,079	0,237	0,095	3,112	0,104	15851	33302
FSE-0331	3,312	3,140	0,248	0,115	3,174	0,124	16154	39088
FSE-0337	3,375	3,203	0,248	0,115	3,237	0,124	16461	39831
FSE-0343	3,437	3,264	0,248	0,115	3,299	0,124	16763	40563
FSE-0350	3,500	3,326	0,248	0,115	3,362	0,124	17071	41307
FSE-0356	3,562	3,378	0,248	0,115	3,424	0,124	17373	42038
FSE-0362	3,625	3,451	0,248	0,115	3,487	0,124	17680	42782
FSE-0368	3,687	3,512	0,248	0,115	3,549	0,124	17983	43514
FSE-0375	3,750	3,570	0,248	0,115	3,612	0,124	18290	44257
FSE-0381	3,812	3,636	0,248	0,115	3,674	0,124	18592	44989
FSE-0387	3,875	3,689	0,248	0,115	3,737	0,124	18900	45732
FSE-0393	3,937	3,760	0,248	0,115	3,799	0,124	19202	46464
FSE-0400	4,000	3,828	0,248	0,115	3,862	0,124	19509	47208
FSE-0412	4,125	3,930	0,265	0,153	3,967	0,163	23035	62126
FSE-0425	4,250	4,050	0,265	0,153	4,092	0,163	23733	64008
FSE-0437	4,375	4,174	0,265	0,153	4,217	0,163	24431	65891
FSE-0450	4,500	4,297	0,265	0,153	4,342	0,163	25129	67774
FSE-0462	4,625	4,421	0,265	0,153	4,467	0,163	25827	69656
FSE-0475	4,750	4,530	0,265	0,153	4,592	0,163	26525	71539
FSE-0487	4,875	4,668	0,265	0,153	4,717	0,163	27223	73421
FSE-0500	5,000	4,792	0,265	0,153	4,842	0,163	27921	75304
FSE-0525	5,250	5,039	0,265	0,153	5,092	0,163	29317	79069
FSE-0550	5,500	5,292	0,265	0,153	5,342	0,163	30713	82834
FSE-0575	5,750	5,535	0,265	0,153	5,592	0,163	32109	86599
FSE-0600	6,000	5,744	0,316	0,153	5,804	0,163	41563	90365
FSE-0625	6,250	5,992	0,316	0,153	6,054	0,163	43295	94130
FSE-0650	6,500	6,236	0,316	0,153	6,304	0,163	45027	97895
FSE-0675	6,750	6,486	0,316	0,153	6,554	0,163	46759	101727
FSE-0700	7,000	6,734	0,316	0,153	6,804	0,163	48490	105494
FSE-0725	7,250	6,993	0,316	0,153	7,054	0,163	50222	109262
FSE-0750	7,500	7,219	0,316	0,153	7,304	0,163	51954	113030
FSE-0775	7,750	7,477	0,316	0,153	7,554	0,163	53686	116797
FSE-0800	8,000	7,683	0,435	0,192	7,764	0,203	66727	142932
FSE-0825	8,250	7,940	0,435	0,192	8,014	0,203	68813	147399
FSE-0850	8,500	8,179	0,435	0,192	8,264	0,203	70898	151866
FSE-0875	8,750	8,427	0,435	0,192	8,514	0,203	72983	156332
FSE-0900	9,000	8,673	0,435	0,192	8,764	0,203	75068	160799
FSE-0925	9,250	8,922	0,435	0,192	9,014	0,203	77154	165265
FSE-0950	9,500	9,130	0,435	0,192	9,240	0,203	82797	169732
FSE-0975	9,750	9,393	0,435	0,192	9,490	0,203	89594	174199
FSE-1000	10,000	9,586	0,500	0,192	9,686	0,203	110977	178665
FSE-1025	10,250	9,826	0,500	0,192	9,936	0,203	113751	183132
FSE-1050	10,500	10,081	0,500	0,192	10,186	0,203	116526	187599
FSE-1075	10,750	10,329	0,500	0,192	10,436	0,203	119300	192065
FSE-1100	11,000	10,584	0,500	0,192	10,686	0,203	122074	196532

¹ Add suffix "-S02" for 302 stainless steel.

² Based on a groove material yield strength of 45,000 psi and a safety factor of 2.

³ Based on a safety factor of 3.

⁴ See pages 134 – 135 for How to Order.

⁵ 1 lb = 4,448 N

1 psi = 0,0069 N/mm²

1 inch = 25,4 mm

Stock Items available in carbon steel and 302 stainless steel.

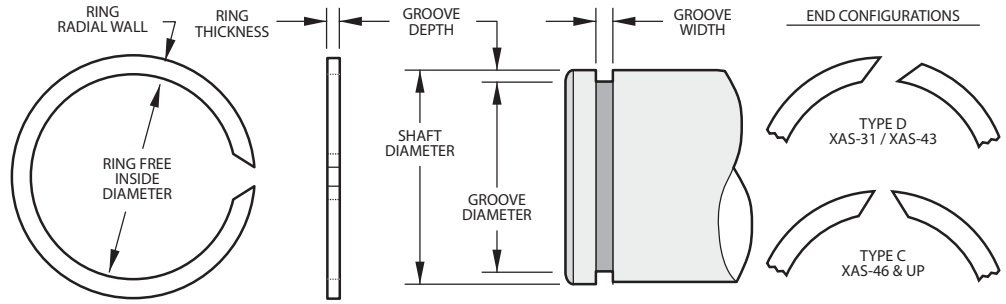

Product Dimensions All dimensions in inches unless otherwise specified.

Smalley Part Number ^{1,4}	Shaft Diameter	Ring			Groove		Thrust Capacity	
		Inside Diameter	Radial Wall	Thickness	Diameter	Width	Groove Yield (lb) ²	Ring Shear (lb) ³
XAS-31	0,312	0,281	0,040	0,025	0,290	0,028	243	977
XAS-34	0,344	0,312	0,040	0,025	0,322	0,028	267	1077
XAS-35	0,354	0,320	0,040	0,025	0,330	0,028	300	1108
XAS-37	0,375	0,341	0,040	0,025	0,351	0,028	318	1174
XAS-39	0,393	0,359	0,040	0,025	0,369	0,028	333	1231
XAS-40	0,406	0,372	0,040	0,025	0,382	0,028	344	1271
XAS-43	0,438	0,402	0,040	0,025	0,412	0,028	402	1371
XAS-46	0,469	0,433	0,040	0,025	0,443	0,028	431	1468
XAS-50	0,500	0,464	0,048	0,035	0,474	0,039	459	2073
XAS-55	0,551	0,514	0,048	0,035	0,524	0,039	526	2285
XAS-56	0,562	0,524	0,048	0,035	0,534	0,039	556	2331
XAS-59	0,594	0,555	0,048	0,035	0,566	0,039	588	2463
XAS-62	0,625	0,586	0,062	0,035	0,597	0,039	619	2592
XAS-66	0,669	0,630	0,062	0,035	0,640	0,039	686	2774
XAS-68	0,688	0,644	0,062	0,042	0,656	0,046	778	3458
XAS-75	0,750	0,703	0,062	0,042	0,716	0,046	901	3770
XAS-78	0,781	0,733	0,062	0,042	0,745	0,046	994	3926
XAS-81	0,812	0,764	0,062	0,042	0,776	0,046	1033	4082
XAS-87	0,875	0,820	0,078	0,042	0,835	0,046	1237	4398
XAS-93	0,938	0,881	0,078	0,042	0,896	0,046	1392	4715
XAS-98	0,984	0,925	0,078	0,042	0,940	0,046	1530	4946
XAS-100	1,000	0,941	0,093	0,042	0,956	0,046	1555	5027
XAS-102	1,023	0,962	0,093	0,042	0,977	0,046	1663	5142
XAS-106	1,062	1,000	0,093	0,050	1,016	0,056	1727	6272
XAS-112	1,125	1,060	0,093	0,050	1,075	0,056	1988	6644
XAS-118	1,188	1,121	0,093	0,050	1,136	0,056	2183	7017
XAS-125	1,250	1,179	0,093	0,050	1,194	0,056	2474	7383
XAS-131	1,312	1,232	0,093	0,050	1,250	0,056	2875	7749
XAS-137	1,375	1,291	0,109	0,050	1,309	0,056	3207	8121
XAS-143	1,438	1,351	0,109	0,050	1,370	0,056	3456	8493
XAS-150	1,500	1,408	0,109	0,050	1,430	0,056	3711	8859
XAS-156	1,562	1,467	0,125	0,062	1,490	0,068	3975	11002
XAS-162	1,625	1,527	0,125	0,062	1,551	0,068	4250	11446
XAS-168	1,687	1,581	0,125	0,062	1,611	0,068	4531	11882
XAS-175	1,750	1,640	0,125	0,062	1,670	0,068	4948	12326
XAS-177	1,771	1,657	0,141	0,062	1,687	0,068	5258	12474
XAS-181	1,812	1,698	0,141	0,062	1,728	0,068	5379	12763
XAS-187	1,875	1,759	0,156	0,062	1,789	0,068	5699	13206
XAS-196	1,969	1,849	0,156	0,062	1,879	0,068	6263	13869
XAS-200	2,000	1,880	0,156	0,062	1,910	0,068	6362	14087
XAS-206	2,062	1,936	0,156	0,078	1,966	0,086	6996	17491
XAS-212	2,125	1,997	0,156	0,078	2,027	0,086	7360	18025
XAS-215	2,156	2,026	0,156	0,078	2,056	0,086	7620	18288
XAS-225	2,250	2,116	0,156	0,078	2,146	0,086	8270	19085
XAS-231	2,312	2,174	0,187	0,078	2,204	0,086	8825	19611
XAS-237	2,375	2,235	0,187	0,078	2,265	0,086	9233	20145
XAS-243	2,437	2,295	0,187	0,078	2,325	0,086	9647	20671
XAS-250	2,500	2,356	0,187	0,078	2,386	0,086	10073	21206

¹ Add suffix "-S02" for 302 stainless steel.

² Based on a groove material yield strength of 45,000 psi and a safety factor of 2.

³ Based on a safety factor of 3.

⁴ See pages 134 –135 for How to Order.

⁵ 1 lb = 4,448 N

1 psi = 0,0069 N/mm²

1 inch = 25,4 mm

Stock Items available in carbon steel and 302 stainless steel.

Product Dimensions All dimensions in inches unless otherwise specified.

Smalley Part Number ^{1,4}	Shaft Diameter	Ring			Groove		Thrust Capacity	
		Inside Diameter	Radial Wall	Thickness	Diameter	Width	Groove Yield (lb) ²	Ring Shear (lb) ³
XAS-255	2,559	2,413	0,187	0,078	2,443	0,086	10491	21706
XAS-262	2,625	2,475	0,187	0,078	2,505	0,086	11133	22266
XAS-268	2,687	2,535	0,187	0,078	2,565	0,086	11586	22792
XAS-275	2,750	2,594	0,187	0,093	2,624	0,103	12246	27992
XAS-287	2,875	2,713	0,187	0,093	2,743	0,103	13413	29264
XAS-293	2,937	2,771	0,187	0,093	2,801	0,103	14117	29895
XAS-300	3,000	2,830	0,218	0,093	2,860	0,103	14844	30536
XAS-306	3,062	2,890	0,218	0,093	2,920	0,103	15367	31167
XAS-312	3,125	2,951	0,218	0,093	2,981	0,103	15904	31809
XAS-315	3,156	2,980	0,218	0,093	3,010	0,103	16285	32124
XAS-325	3,250	3,070	0,250	0,093	3,100	0,103	17230	33081
XAS-334	3,344	3,160	0,250	0,093	3,190	0,103	18201	34038
XAS-343	3,437	3,251	0,250	0,093	3,281	0,103	18950	34984
XAS-350	3,500	3,305	0,250	0,109	3,340	0,120	19792	40017
XAS-354	3,543	3,346	0,250	0,109	3,381	0,120	20286	40508
XAS-362	3,625	3,423	0,250	0,109	3,458	0,120	21396	41446
XAS-368	3,687	3,482	0,250	0,109	3,517	0,120	22153	42155
XAS-375	3,750	3,541	0,250	0,109	3,576	0,120	23061	42875
XAS-387	3,875	3,657	0,281	0,109	3,697	0,120	24378	44304
XAS-393	3,938	3,713	0,281	0,109	3,758	0,120	25052	45024
XAS-400	4,000	3,771	0,281	0,109	3,816	0,120	26012	45733
XAS-425	4,250	4,016	0,281	0,109	4,066	0,120	27638	48592
XAS-437	4,375	4,141	0,281	0,109	4,191	0,120	28451	50021
XAS-450	4,500	4,255	0,312	0,109	4,310	0,120	30218	51450
XAS-475	4,750	4,495	0,312	0,109	4,550	0,120	33576	54308
XAS-500	5,000	4,730	0,312	0,109	4,790	0,120	37110	57167
XAS-525	5,250	4,970	0,375	0,125	5,030	0,139	40821	65732
XAS-550	5,500	5,206	0,375	0,125	5,266	0,139	45486	68862
XAS-575	5,750	5,446	0,375	0,125	5,506	0,139	49586	71992
XAS-590	5,900	5,600	0,375	0,125	5,656	0,139	50880	73870
XAS-600	6,000	5,687	0,375	0,125	5,746	0,139	53863	75122
XAS-625	6,250	5,916	0,437	0,156	5,986	0,174	58316	94130
XAS-650	6,500	6,151	0,437	0,156	6,226	0,174	62946	97895
XAS-675	6,750	6,386	0,437	0,156	6,466	0,174	67752	101660
XAS-700	7,000	6,621	0,437	0,156	6,706	0,174	72736	105426
XAS-725	7,250	6,840	0,500	0,187	6,930	0,209	81996	124330
XAS-750	7,500	7,090	0,500	0,187	7,180	0,209	84823	128617
XAS-800	8,000	7,560	0,500	0,187	7,660	0,209	96133	137191
XAS-850	8,500	8,050	0,500	0,187	8,160	0,209	102141	145766
XAS-900	9,000	8,545	0,500	0,187	8,660	0,209	108149	154340
XAS-925	9,250	8,800	0,500	0,187	8,910	0,209	111153	158627
XAS-950	9,500	9,040	0,500	0,187	9,160	0,209	114158	162915
XAS-1000	10,000	9,535	0,500	0,187	9,660	0,209	120166	171489

¹ Add suffix "-S02" for 302 stainless steel.

² Based on a groove material yield strength of 45,000 psi and a safety factor of 2.

³ Based on a safety factor of 3.

⁴ See pages 134 –135 for How to Order.

⁵ 1 lb = 4,448 N

1 psi = 0,0069 N/mm²

1 inch = 25,4 mm

Stock Items available in carbon steel and 302 stainless steel.

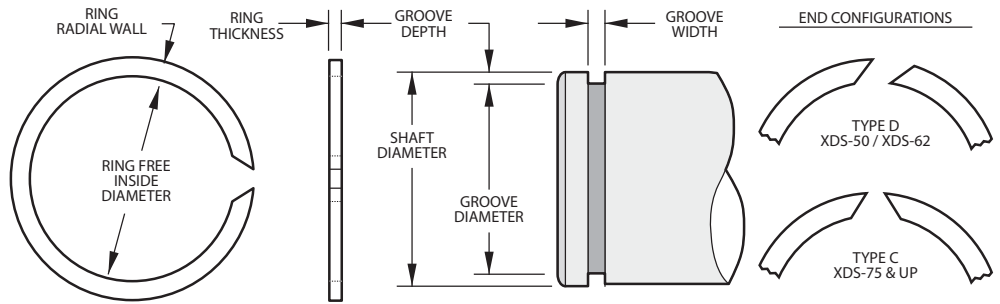

Product Dimensions All dimensions in inches unless otherwise specified.

Smalley Part Number ^{1,4}	Shaft Diameter	Ring			Groove		Thrust Capacity	
		Inside Diameter	Radial Wall	Thickness	Diameter	Width	Groove Yield (lb) ²	Ring Shear (lb) ³
XDS-50	0,500	0,465	0,048	0,035	0,474	0,039	459	2073
XDS-62	0,625	0,587	0,062	0,035	0,597	0,039	619	2592
XDS-75	0,750	0,704	0,078	0,042	0,716	0,046	901	3770
XDS-87	0,875	0,823	0,093	0,042	0,833	0,046	1299	4398
XDS-100	1,000	0,944	0,093	0,042	0,954	0,046	1626	5027
XDS-112	1,125	1,065	0,125	0,042	1,077	0,046	1909	5655
XDS-118	1,187	1,120	0,125	0,042	1,135	0,046	2182	5967
XDS-125	1,250	1,179	0,125	0,042	1,194	0,046	2474	6283
XDS-131	1,312	1,232	0,125	0,042	1,252	0,046	2782	6595
XDS-137	1,375	1,289	0,125	0,042	1,309	0,046	3207	6912
XDS-143	1,437	1,349	0,125	0,042	1,369	0,046	3454	7223
XDS-150	1,500	1,410	0,125	0,042	1,430	0,046	3711	7540
XDS-162	1,625	1,520	0,156	0,042	1,545	0,046	4595	8168
XDS-168	1,687	1,582	0,156	0,042	1,607	0,046	4770	8480
XDS-175	1,750	1,645	0,156	0,042	1,670	0,046	4948	8796
XDS-193	1,937	1,832	0,156	0,042	1,857	0,046	5477	9736
XDS-200	2,000	1,895	0,156	0,042	1,920	0,046	5655	10053
XDS-218	2,187	2,082	0,156	0,042	2,107	0,046	6184	10993
XDS-225	2,250	2,145	0,156	0,042	2,170	0,046	6362	11310
XDS-237	2,375	2,270	0,156	0,042	2,295	0,046	6715	11938
XDS-250	2,500	2,390	0,156	0,042	2,420	0,046	7069	12566
XDS-275	2,750	2,596	0,187	0,062	2,626	0,068	12052	19369
XDS-293	2,937	2,783	0,187	0,062	2,813	0,068	12871	20687
XDS-300	3,000	2,846	0,187	0,062	2,876	0,068	13148	21130
XDS-312	3,125	2,965	0,187	0,062	3,000	0,068	13806	22011
XDS-325	3,250	3,090	0,187	0,062	3,125	0,068	14358	22891
XDS-337	3,375	3,215	0,187	0,062	3,250	0,068	14910	23772
XDS-350	3,500	3,340	0,187	0,062	3,375	0,068	15463	24652
XDS-375	3,750	3,570	0,218	0,078	3,610	0,086	18555	31809
XDS-400	4,000	3,820	0,218	0,078	3,860	0,086	19792	33929
XDS-425	4,250	4,070	0,218	0,078	4,110	0,086	21029	36050
XDS-450	4,500	4,320	0,218	0,078	4,360	0,086	22266	38170
XDS-475	4,750	4,560	0,218	0,078	4,610	0,086	23503	40291
XDS-500	5,000	4,800	0,218	0,078	4,860	0,086	24740	42412
XDS-550	5,500	5,280	0,250	0,093	5,340	0,103	31102	55983
XDS-600	6,000	5,775	0,250	0,093	5,840	0,103	33929	61073
XDS-650	6,500	6,270	0,250	0,093	6,340	0,103	36757	66162
XDS-700	7,000	6,765	0,250	0,093	6,840	0,103	39584	71251
XDS-750	7,500	7,245	0,281	0,109	7,320	0,120	47713	85750
XDS-800	8,000	7,740	0,281	0,109	7,820	0,120	50894	91466

¹ Add suffix "-S02" for 302 stainless steel.

² Based on a groove material yield strength of 45,000 psi and a safety factor of 2.

³ Based on a safety factor of 3.

⁴ See pages 134 –135 for How to Order.

A Smalley Laminar Seal Ring set is a metallic labyrinth seal consisting of multiple rings in a groove. The arrangement and the specific orientation of the rings are dictated by the application and the severity of the environment. There are 16 series of standard imperial and Metric Laminar Seal Ring configurations from which to select. 8 of these series are sets consisting of single-turn rings. The other 8 series are sets consisting of double-turn rings. Within each series are operational ring-set configurations in both imperial and metric sizes. The selection of the appropriate set should be determined by the application. For some applications a complete labyrinth configuration (i.e.; a complete labyrinth configuration is one which has rings staggered within the set) is necessary due to a severe environment where contamination is highly probable. In other applications design engineers can keep the groove dimensions minimal by specifying laminar sets with rings clinging either to the bore or to the shaft.

Laminar Seal Rings Available From Stock

Standard parts from 15 mm to 1300 mm and 5/8" to 50".
 Special seals manufactured with No-Tooling-Charges.
 Smalley's Laminar Seal Rings are interchangeable with FEY Rings.



INTERCHANGE LISTING		
SMALLEY	FEY	
QH	AS	FK3
QHK	ASK	
QS	IS	
QSK	ISK	
QHD	ASD	FK6
QHKD	ASKD	
QSD	ISD	
QSKD	ISKD	
CONSULT SMALLEY ENGINEERING		FK5

Advantages of Laminar Seal Rings

- No friction with other rotating components, ideal for high speed applications.
- Prevent dirt and splash water from contaminating components.
- When used in conjunction with other seals, Laminar Seals provide a primary seal against severe contamination, before the contaminants come in contact with the secondary seal.
- Sets of multiple rings provide an efficient labyrinth seal.
- Rings may be produced from a wide variety of alloys to withstand more severe conditions including higher temperatures and corrosive environments.
- As a metallic mechanical seal they can outperform rubber seals in durability and life expectancy.
- The change from rubber to metal reduces the need for frequent seal replacement.

Selection Guide Standard Laminar Ring Sets Available

Single-Turn Laminar Seal Rings

Used in a variety of applications, this series of Seal Rings should be utilized for light to medium duty applications, dependent on the ring configuration specified. The sets are comprised of single-turn rings in either 3 rings per set or 5 rings per set.

APPLICATIONS: 3 ring sets protect components from low dirt and low splash water contamination. 5 ring sets provide a better labyrinth seal to protect components from medium dirt and medium splash water contamination.



**YH Series
QH Series**
Internal - Light Duty
1 set = 3 individual rings
(rings rotate with bore only)



**YHK Series
QHK Series**
Internal - Medium Duty
1 set = 5 individual rings
(3 rings rotate with bore &
2 rings rotate with shaft)



**YS Series
QS Series**
External - Light Duty
1 set = 3 individual rings
(rings rotate with shaft only)



**YSK Series
QSK Series**
External - Medium Duty
1 set = 5 individual rings
(3 rings rotate with shaft &
2 rings rotate with bore)

Double-Turn Laminar Seal Rings

The sets are comprised of double-turn rings in either 2 rings per set or 3 rings per set. The double-turn rings fit tighter in the bore or on the shaft, provide complete 360° surface contact and resist higher axial/radial forces than single-turn ring sets, for medium to heavy duty applications.

APPLICATIONS: 2 ring sets protect components from medium dirt and medium splash water contamination. 3 ring sets provide a better labyrinth seal to protect components from heavy dirt and heavy splash water contamination.



**YHD Series
QHD Series**
Internal - Medium/Heavy Duty
1 set = 2 individual rings
(rings rotate with bore only)



**YHKD Series
QHKD Series**
Internal - Heavy Duty
1 set = 3 individual rings
(2 rings rotate with bore &
1 ring rotates with shaft)



**YSD Series
QSD Series**
External - Medium/Heavy Duty
1 set = 2 individual rings
(rings rotate with shaft only)



**YSKD Series
QSKD Series**
External - Heavy Duty
1 set = 3 individual rings
(2 rings rotate with shaft &
1 ring rotates with bore)

A. Coupling

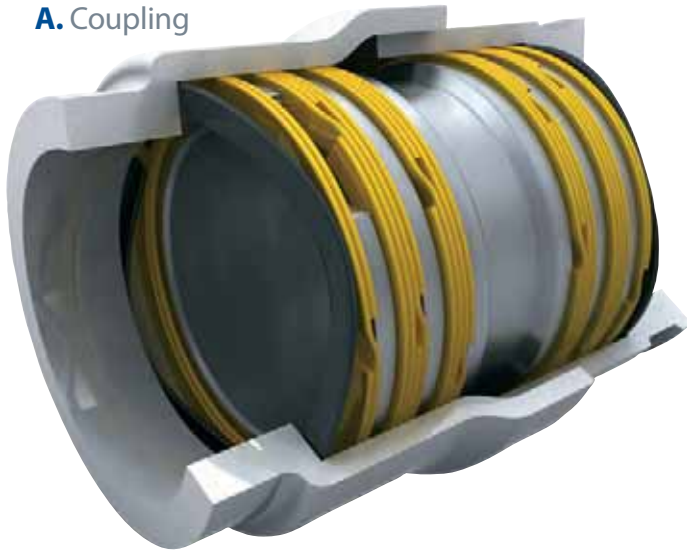

B. Bearing Protection



C. Pulley Idler



D. High Speed Spindle



A. Coupling

The seal arrangement in this assembly has been custom designed for optimum protection against contamination. Gases build up pressure in a center cavity, protected on both ends from contaminants entering.

B. Bearing Protection

The 3 ring set protects the ball bearing from contaminants like dirt and water. The seal retains grease/lubricant and prevents contaminants from penetrating into the critical components of the assembly.

C. Pulley Idler

The ring set designed in this application extends the life of the ball bearing by keeping contaminants from penetrating the precision bearing surfaces even though the bearing itself is sealed. When the shaft rotates only the groove ring rotates while the housing rings remain stationary.

D. High Speed Spindle

The QS series has been designed into the spindle assembly to protect the tandem bearings against corrosive elements. Though it is not the primary seal in the assembly, it is designed as the final seal protecting the bearings. All rings in the set will cling to the shaft due to the high rotational speed of the main spindle.

Single-Turn Laminar Sealing Rings QH or QS are used for a wide variety of applications. They are commonly used to protect bearing systems by retaining grease/lubricant and preventing water or other contaminating liquids from penetrating into the critical areas of an assembly. The alternating (staggered) series QHK and QSK offer (due to an increased labyrinth seal) further improved sealing efficiency. They are often specified where the lubricating grease may liquefy due to higher operating temperatures or where protection against larger amounts of contaminating liquids (such as cooling water) is required.

The Metric Single-Turn Laminar Rings listed in the table below are readily available (from stock). Specials can be manufactured with No-Tooling-Charges™.

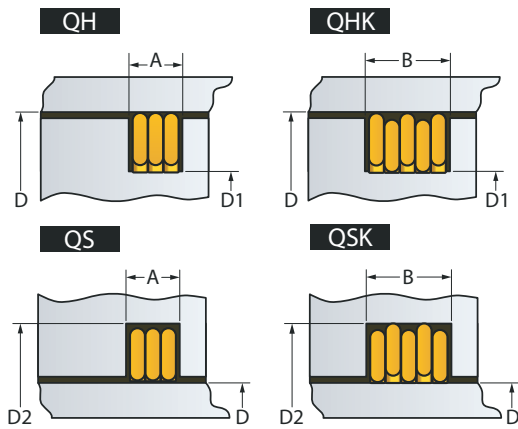
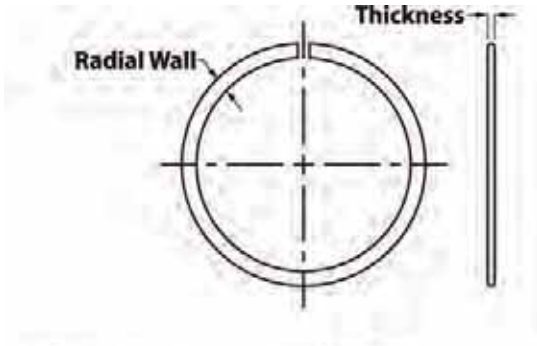

Product Dimensions All dimensions in millimeters unless otherwise specified.

Bore Shaft D	Groove ² Width		Ring Dimensions		Groove Diameter D2	Groove Diameter D1
	A	B	RW	T		
15	- 24,9	2,2	3,6	1,0	0,65	(D) + 2,6 (D) - 2,6
25	- 29,9	2,2	3,6	1,2	0,65	+ 3,0 - 3,0
30	- 35,9	2,2	3,6	1,5	0,65	+ 3,6 - 3,6
36	- 42,9	2,2	3,6	1,8	0,65	+ 4,2 - 4,2
43	- 48,9	2,4	4,0	2,2	0,72	+ 5,0 - 5,0
49	- 51,9	2,4	4,0	2,4	0,72	+ 5,4 - 5,4
52	- 59,9	2,4	4,0	2,6	0,72	+ 5,8 - 5,8
60	- 69,9	2,7	4,5	2,8	0,82	+ 6,2 - 6,2
70	- 74,9	2,7	4,5	3,1	0,82	+ 6,8 - 6,8
75	- 79,9	2,7	4,5	3,3	0,82	+ 7,2 - 7,2
80	- 89,9	2,7	4,5	3,5	0,82	+ 7,6 - 7,6
90	- 99,9	2,7	4,5	3,8	0,82	+ 8,2 - 8,2
100	- 104,9	2,7	4,5	4,1	0,82	+ 8,8 - 8,8
105	- 109,9	3,3	5,5	4,3	0,98	+ 9,2 - 9,2
110	- 119,9	3,3	5,5	4,6	0,98	+ 9,8 - 9,8
120	- 129,9	3,3	5,5	5,0	0,98	+10,8 -10,8
130	- 149,9	3,3	5,5	5,5	0,98	+11,8 -11,8
150	- 170,9	3,4	5,6	6,0	1,00	+13,0 -13,0
150 ¹	- 170,9	5,1	8,2	6,0	1,50	+13,0 -13,0
171	- 199,9	3,4	5,6	7,0	1,00	+15,0 -15,0
171 ¹	- 199,9	5,1	8,2	7,0	1,50	+15,0 -15,0
200	- 259,9	4,1	6,6	8,0	1,20	+18,0 -18,0
200 ¹	- 259,9	5,1	8,2	8,0	1,50	+18,0 -18,0
260	- 319,9	5,1	8,2	9,0	1,50	+20,0 -20,0
320	- 399,9	5,2	8,3	10,0	1,50	+22,0 -22,0
400	- 439,9	5,2	8,3	11,0	1,50	+24,0 -24,0
440	- 600,9	5,2	8,3	12,0	1,50	+26,0 -26,0
440 ¹	- 600,0	8,3	13,5	12,0	2,50	+26,0 -26,0
601	- 699,9	8,3	13,5	14,0	2,50	+32,0 -32,0
700	- 799,9	8,3	13,5	16,0	2,50	+36,0 -36,0
800	- 899,9	8,3	13,5	18,0	2,50	+40,0 -40,0
900	- 999,9	8,3	13,5	20,0	2,50	+44,0 -44,0
1000	- 1300,0	8,4	13,6	22,0	2,50	+48,0 -48,0

Tolerances (mm)				
D	15 - 104,9	105 - 149,9	150 - 439,9	440 - 1300
A-B	+0,10 -0,00	+0,15 -0,00	+0,20 -0,00	+0,25 -0,00
RW	+0,10 -0,10	+0,10 -0,20	+0,15 -0,30	+0,20 -0,40
T	+0,04 -0,02	+0,05 -0,03	+0,06 -0,04	+0,07 -0,05
D2	+0,20 -0,00	+0,25 -0,00	+0,30 -0,00	+0,40 -0,00
D1	+0,00 -0,20	+0,00 -0,25	+0,00 -0,30	+0,00 -0,40

¹ Increased cross-section.

² If axial movement occurs during operation, an increase to Groove Width may be necessary to avoid friction between Rings and Groove.

Double-Turn Laminar Sealing Rings offer a higher clamping force when installed in the bore or on the shaft. They are suited for higher operating speeds, have 360° contact (no axial gap) and should be used where application conditions are more severe. One typical application is where high amounts of dirt and dust are present and the ring sets provide the necessary seal against contamination from outside elements.

Double-Turn Laminar Ring Sets are also used to protect contacting radial seals, rubber seals, O-rings and other oil seals. For protection in the most severe environment the alternating (staggered) sets QHKD and QSKD are the preferred choice by engineers. They provide sealing with 360° contact in both the bore and on the shaft.

The Metric Double-Turn Laminar Rings listed in the table below are readily available (from stock). Specials can be manufactured with No-Tooling-Charges™.

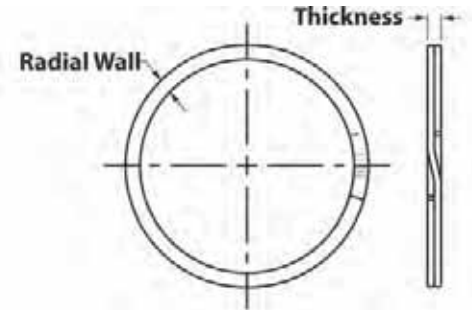

Product Dimensions All dimensions in millimeters unless otherwise specified.

Bore Shaft D	Groove ² Width		Ring Dimensions		Groove Diameter D2	Groove Diameter D1		
	A	B	RW	T				
15	-	24,9	2,9	4,3	1,0	1,30	(D) + 2,6	(D) - 2,6
25	-	29,9	2,9	4,3	1,2	1,30	+3,0	-3,0
30	-	35,9	2,9	4,3	1,5	1,30	+3,6	-3,6
36	-	42,9	2,9	4,3	1,8	1,30	+4,2	-4,2
43	-	48,9	3,2	4,8	2,2	1,45	+5,0	-5,0
49	-	51,9	3,2	4,8	2,4	1,45	+5,4	-5,4
52	-	59,9	3,2	4,8	2,6	1,45	+5,8	-5,8
60	-	69,9	3,6	5,4	2,8	1,65	+6,2	-6,2
70	-	74,9	3,6	5,4	3,1	1,65	+6,8	-6,8
75	-	79,9	3,6	5,4	3,3	1,65	+7,2	-7,2
80	-	89,9	3,6	5,4	3,5	1,65	+7,6	-7,6
90	-	99,9	3,6	5,4	3,8	1,65	+8,2	-8,2
100	-	104,9	3,6	5,4	4,1	1,65	+8,8	-8,8
105	-	109,9	4,3	6,4	4,3	1,96	+9,2	-9,2
110	-	119,9	4,3	6,4	4,6	1,96	+9,8	-9,8
120	-	129,9	4,3	6,4	5,0	1,96	+10,8	-10,8
130	-	149,9	4,3	6,4	5,5	1,96	+11,8	-11,8
150	-	170,9	4,4	6,5	6,0	2,00	+13,0	-13,0
150 ¹	-	170,9	6,5	9,6	6,0	3,00	+13,0	-13,0
171	-	199,9	4,4	6,5	7,0	2,00	+15,0	-15,0
171 ¹	-	199,9	6,5	9,6	7,0	3,00	+15,0	-15,0
200	-	259,9	5,3	7,8	8,0	2,40	+18,0	-18,0
200 ¹	-	259,9	6,5	9,6	8,0	3,00	+18,0	-18,0
260	-	319,9	6,5	9,6	9,0	3,00	+20,0	-20,0
320	-	399,9	6,6	9,8	10,0	3,00	+22,0	-22,0
400	-	439,9	6,6	9,8	11,0	3,00	+24,0	-24,0
440	-	600,9	6,6	9,8	12,0	3,00	+26,0	-26,0
440 ¹	-	600,9	10,6	15,9	12,0	5,00	+26,0	-26,0
601	-	699,9	10,8	16,2	14,0	5,00	+32,0	-32,0
700	-	799,9	10,8	16,2	16,0	5,00	+36,0	-36,0
800	-	899,9	11,0	16,5	18,0	5,00	+40,0	-40,0
900	-	999,9	11,0	16,5	20,0	5,00	+44,0	-44,0
1000	-	1300,0	11,0	16,5	22,0	5,00	+48,0	-48,0

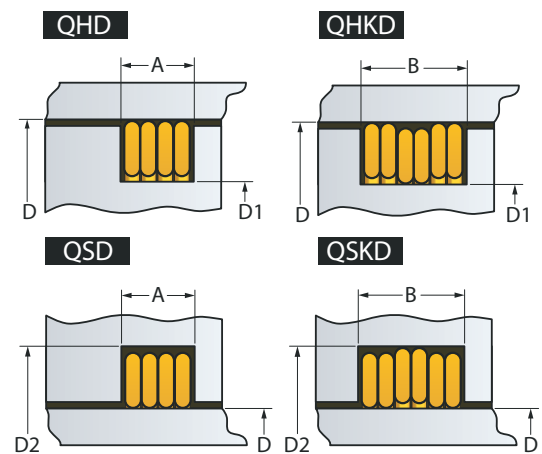

Tolerances (mm)				
D	15 - 104,9	105 - 149,9	150 - 439,9	440 - 1300
A-B	+0,10 -0,00	+0,15 -0,00	+0,20 -0,00	+0,25 -0,00
RW	+0,10 -0,10	+0,10 -0,20	+0,15 -0,30	+0,20 -0,40
T	+0,08 -0,04	+0,10 -0,06	+0,12 -0,08	+0,14 -0,10
D2	+0,20 -0,00	+0,25 -0,00	+0,30 -0,00	+0,40 -0,00
D1	+0,00 -0,20	+0,00 -0,25	+0,00 -0,30	+0,00 -0,40

¹ Increased cross-section.

² If axial movement occurs during operation, an increase to Groove Width may be necessary to avoid friction between Rings and Groove.

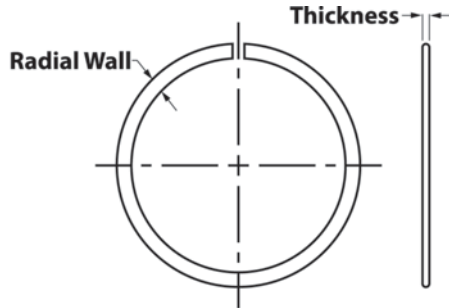

Single-Turn Laminar Sealing Rings YH or YS are used for a wide variety of applications. They are commonly used to protect bearing systems by retaining grease/lubricant and preventing water or other contaminating liquids from penetrating into the critical areas of an assembly. The alternating (staggered) series YHK and YSK offer (due to an increased labyrinth seal) further improved sealing efficiency. They are often specified where the lubricating grease may liquefy due to higher operating temperatures or where protection against larger amounts of contaminating liquids (such as cooling water) is required.

The Imperial Single-Turn Laminar Rings listed in the table below are readily available (from stock). Specials can be manufactured with No-Tooling-Charges™.

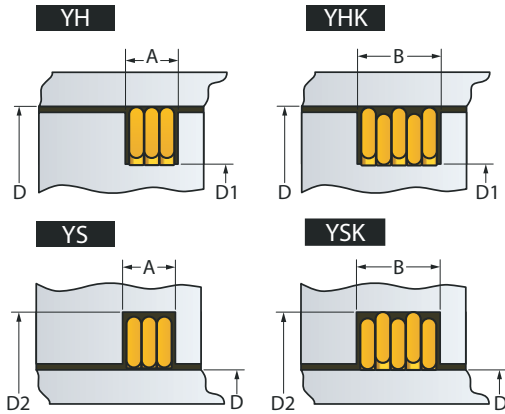

Product Dimensions All dimensions in inches unless otherwise specified.

Bore Shaft ¹ D	Groove ² Width		Ring Dimensions		Groove Diameter D2	Groove Diameter D1
	A	B	RW	T		
0,625 - 1,249	0,072	0,119	0,055	0,021	(D) +0,134	(D) -0,134
1,250 - 1,499	0,072	0,119	0,065	0,021	+0,154	-0,154
1,500 - 1,749	0,084	0,139	0,078	0,025	+0,180	-0,180
1,750 - 2,249	0,102	0,170	0,095	0,031	+0,214	-0,214
2,250 - 2,749	0,102	0,170	0,113	0,031	+0,250	-0,250
2,750 - 2,999	0,102	0,170	0,123	0,031	+0,270	-0,270
3,000 - 3,249	0,102	0,170	0,128	0,031	+0,280	-0,280
3,250 - 3,499	0,102	0,170	0,138	0,031	+0,300	-0,300
3,500 - 3,999	0,102	0,170	0,158	0,031	+0,340	-0,340
4,000 - 4,499	0,102	0,170	0,168	0,031	+0,360	-0,360
4,500 - 4,999	0,131	0,215	0,188	0,039	+0,408	-0,408
5,000 - 5,499	0,131	0,215	0,200	0,039	+0,432	-0,432
5,500 - 6,249	0,158	0,254	0,225	0,046	+0,490	-0,490
6,250 - 7,749	0,187	0,301	0,250	0,055	+0,540	-0,540
7,750 - 9,999	0,187	0,301	0,312	0,055	+0,702	-0,702
10,000 - 12,499	0,217	0,346	0,350	0,063	+0,778	-0,778
12,500 - 14,999	0,217	0,346	0,375	0,063	+0,828	-0,828
15,000 - 19,999	0,307	0,496	0,437	0,093	+0,952	-0,952
20,000 - 24,999	0,310	0,504	0,500	0,093	+1,158	-1,158
25,000 - 29,999	0,310	0,504	0,567	0,093	+1,292	-1,292
30,000 - 50,000	0,310	0,504	0,750	0,093	+1,658	-1,658

Tolerances (in)				
D	0,625 - 4,499	4,500 - 9,999	10,000 - 14,999	15,000 - 50,000
A-B	+0,004 -0,000	+0,008 -0,000	+0,010 -0,000	+0,010 -0,000
RW	+0,004 -0,004	+0,006 -0,006	+0,007 -0,007	+0,015 -0,010
T	+0,002 -0,002	+0,003 -0,003	+0,004 -0,004	+0,005 -0,005
D2	+0,008 -0,000	+0,012 -0,000	+0,012 -0,000	+0,016 -0,000
D1	+0,000 -0,008	+0,000 -0,012	+0,000 -0,012	+0,000 -0,016

¹ Standard raw materials are carbon steel and 302 stainless steel.

² If axial movement occurs during operation, an increase to Groove Width may be necessary to avoid friction between Rings and Groove.

³ 1 inch = 25,4 mm

Double-Turn Laminar Sealing Rings offer a higher clamping force when installed in the bore or on the shaft. They are suited for higher operating speeds, have 360° contact (no axial gap) and should be used where application conditions are more severe. One typical application is where high amounts of dirt and dust are present and the ring sets provide the necessary seal against contamination from outside elements.

Double-Turn Laminar Ring Sets are also used to protect contacting radial seals, rubber seals, O-rings and other oil seals. For protection in the most severe environment the alternating (staggered) sets YHKD and YSKD are the preferred choice by engineers. They provide sealing with 360° contact in both the bore and on the shaft.

The Imperial Double-Turn Laminar Rings listed in the table below are readily available (from stock). Specials can be manufactured with No-Tooling-Charges™.

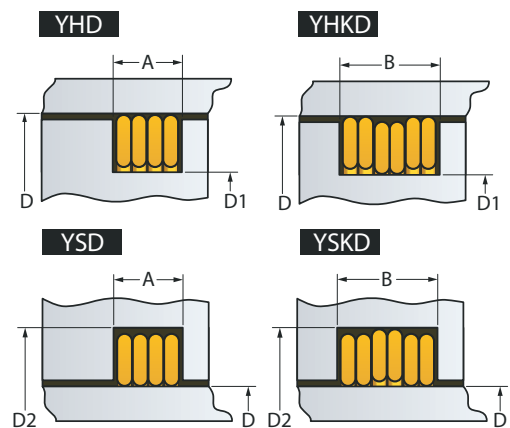
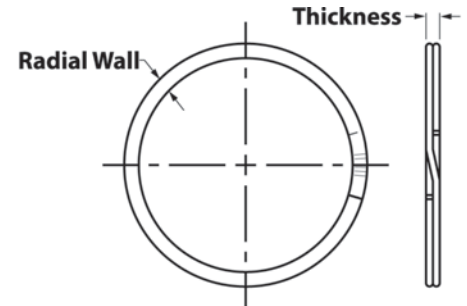

Product Dimensions All dimensions in inches unless otherwise specified.

Bore Shaft ¹ D	Groove ² Width		Ring Dimensions		Groove Diameter D2	Groove Diameter D1
	A	B	RW	T		
0,625 - 1,249	0,098	0,145	0,055	0,043	(D) +0,134	(D) -0,134
1,250 - 1,499	0,098	0,145	0,065	0,043	+0,154	-0,154
1,500 - 1,749	0,112	0,166	0,078	0,050	+0,180	-0,180
1,750 - 2,249	0,136	0,204	0,095	0,062	+0,214	-0,214
2,250 - 2,749	0,136	0,204	0,113	0,062	+0,250	-0,250
2,750 - 2,999	0,136	0,204	0,123	0,062	+0,270	-0,270
3,000 - 3,249	0,136	0,204	0,128	0,062	+0,280	-0,280
3,250 - 3,499	0,136	0,204	0,138	0,062	+0,300	-0,300
3,500 - 3,999	0,136	0,204	0,158	0,062	+0,340	-0,340
4,000 - 4,499	0,136	0,206	0,168	0,062	+0,360	-0,360
4,500 - 4,999	0,172	0,254	0,188	0,078	+0,408	-0,408
5,000 - 5,499	0,172	0,254	0,200	0,078	+0,432	-0,432
5,500 - 6,249	0,202	0,299	0,225	0,093	+0,490	-0,490
6,250 - 7,749	0,238	0,353	0,250	0,111	+0,540	-0,540
7,750 - 9,999	0,242	0,357	0,312	0,111	+0,702	-0,702
10,000 - 12,499	0,274	0,405	0,350	0,127	+0,778	-0,778
12,500 - 14,999	0,278	0,412	0,375	0,127	+0,828	-0,828
15,000 - 19,999	0,398	0,592	0,437	0,187	+0,952	-0,952
20,000 - 24,999	0,398	0,596	0,500	0,187	+1,158	-1,158
25,000 - 29,999	0,405	0,608	0,567	0,187	+1,292	-1,292
30,000 - 50,000	0,413	0,620	0,750	0,187	+1,658	-1,658

Tolerances (in)				
D	0,625 - 4,499	4,500 - 9,999	10,000 - 14,999	15,000 - 50,000
A-B	+0,004 -0,000	+0,008 -0,000	+0,010 -0,000	+0,010 -0,000
RW	+0,004 -0,004	+0,006 -0,006	+0,007 -0,007	+0,015 -0,010
T	+0,002 -0,002	+0,003 -0,003	+0,004 -0,004	+0,005 -0,005
D2	+0,008 -0,000	+0,012 -0,000	+0,012 -0,000	+0,016 -0,000
D1	+0,000 -0,008	+0,000 -0,012	+0,000 -0,012	+0,000 -0,016

¹ Standard raw materials are carbon steel and 302 stainless steel.

² If axial movement occurs during operation, an increase to Groove Width may be necessary to avoid friction between Rings and Groove.

³ 1 inch = 25,4 mm

Custom-Made Rings & Springs

Custom For your Application

While Smalley has a large selection of stock retaining rings and wave springs to choose from, the uniqueness of applications often demands a ring or spring to conform to application-specific requirements. Our No-Tooling-Cost process provides an economical alternative, to produce a custom ring or spring to meet your exact specifications. Think of it as modifying a standard; change the diameter, material size, alloy or nearly any product characteristic to fit within your assembly. It's really a simple solution to get exactly what works best. At Smalley, specials are standard, as many of our accounts take advantage of getting exactly what works best. Retaining rings and wave springs are often the last design consideration in an assembly and commonly have to fit in restrictive spaces and need to provide critical operating characteristics. Having the ability to easily specify non-standard sizes, offers a preferred option designers will often follow.



Economical

A common misconception of special designs is the cost. Because of Smalley's unique manufacturing process, application-specific retaining rings or wave springs can be an economical solution for your unique needs. With Smalley's No-Tooling-Cost process we have the flexibility to quickly manufacture products of different diameter, thickness, material and finish at a minimal cost. This means that during the prototype stage we can produce alternative designs with no tooling modifications. It's not uncommon to produce one prototype for evaluation and subsequently make dimensional adjustments for a second single prototype. That's two setups, NO-TOOLING-CHARGES and a final product produced fast and economically.

Availability

Smalley is vertically integrated with onsite material manufacturing and a large warehouse. We are able to produce custom rings or springs using a wide variety of readily available materials, or can produce custom raw material sizes to meet delivery requirements. For customers who use just-in-time inventory control, Smalley will offer to stock parts for immediate shipment, ready for the next purchase order or blanket order release.

Lead Time

Whether you are looking for prototypes, short-runs or high volumes, Smalley's unique No-Tooling-Cost manufacturing process allows for special designs to be manufactured in a timely fashion. Since no special dies or forming tools are necessary for custom rings or springs, prototypes can be designed and produced in days, not weeks.

Engineering Support

Smalley specializes in the design, development and production of custom retaining rings and wave/compression springs. Our design engineers will tailor a design to meet the exact characteristics necessary for individual function, where certain criteria must be considered. For decades we've been doing exactly this at Smalley.

Smalley brings along the combined experience of our engineering staff in designing retaining rings and wave springs for the most demanding of applications. Our capabilities extend well beyond the ordinary manufacturer as we not only design the rings and springs, we design the machinery they run on. We have in-depth knowledge of mechanical assemblies, machining operations, fitting components, dynamics and a host of other elements in the diverse universe of mechanical components. Product Application Engineers have designed and solved thousands of tough applications for OEMs in nearly every industry. Whether it's exposure to high temperature or a cryogenic environment, a dynamic / fatigue problem or simply a static load, we've been involved and resolved complex design issues.

Smalley engineers establish the manufacturing processes needed. This includes primary coiling operations, secondary operations for special product features such as slots, tabs, holes, bends, hooks, joints, etc., plating and finishing, marking and other characteristics for most any feature required.

To develop a packaging solution, Smalley engineering has created standards with which solutions are offered for consideration. Whether the part is coin-wrapped, bulk packaged, wire tied, on a tube or individually bagged a Smalley engineer is involved with all aspects of handling and shipment.

Optimized Design

Smalley has developed sophisticated software that optimizes the variables in a given design. It considers both the dimensions of the product and the cost to produce the ring or spring. The typical analysis provides a product that performs to specification but does not over-design dimensions and/or materials that can raise costs. Because our No-Tooling-Cost process enables an almost infinite selection of dimensions, the software considers the relationships between maximum stress levels, product configurations and

dimensions, and pushes the limits in the choices available for the best design. Based upon the criteria selected, Smalley engineers work with you to best determine what design alternatives will work best for a particular application. By making simple design changes; such as material thickness, radial wall, number of waves or selecting a different alloy, we can quickly determine the design impact. This time saving technology allows for correct parts to be manufactured and ready to test.

Testing

In-house testing is performed on our products to ensure that they satisfy our stringent quality standards prior to shipment. Statistical Process Control, SPC, is performed on a sampling of parts to verify that critical dimensions are in control. Smalley has the ability to test various application-specific performance characteristics. An example would be cycle life.

Cross-Functional Teams

Housing both the manufacturing and office activities under one roof allows Smalley engineers to be involved in all aspects of support in the manufacturing process. From concept to production our engineers work with quality control, manufacturing, shipping and purchasing to ensure that the design and production process move efficiently and effectively.

Re-Engineering

If you are currently considering using Spirolox Retaining Rings or Smalley Wave Springs to replace an existing product, our engineering department will work with you to choose the best new design for your application. Send Smalley a sample of an existing ring or spring, drawings of the assembly or your design requirements and we will engineer and provide new solutions for your consideration. Once an alternative design is presented, engineering will work with you to obtain exact prototypes or samples of similar products for evaluation and testing.

Mid-Stream design changes can also be accomplished with relative ease. It is not uncommon that dimensions need modification right in the middle of production. Once again, Smalley products can usually be changed at any point in the process by making a machine adjustment, without any tooling changes. You can count on the flexibility Smalley products offer for all your applications.

Materials Table

The table below presents the more common alloys used by Smalley Steel Ring Company.

Material	Material Thickness (mm)	Minimum Tensile Strength (N/mm ²)	Shear Strength (N/mm ²)	Maximum Recommended Operating Temp. ⁴ (°C)	Modulus of Elasticity (N/mm ²)	Chemical	Afnor	Number-DIN
CARBON STEEL								
OIL TEMPERED SAE 1070 - 1090	0,152 - 0,356	1855	1055	121	206843	Carbon steel XC67 to XC75	Not applicable	1,1231-1,1248 ¹
	0,357 - 0,533	1758	1000					
	0,534 - 1,092	1524	869					
	≥1,093	1455	827					
HARD DRAWN SAE 1060 - 1075	0,152 - 0,762	1586	896	204	193053	X10 CrNi 18-8	Not applicable	1,4310
	0,763 - 2,794	1248	710					
	2,795 - 5,588	1076	614					
AISI 302								
AMS-5866	0,051 - 0,559	1448	820	204	193053	X10 CrNi 18-8	Not applicable	1,4310
	0,560 - 1,194	1379	786					
	1,195 - 1,575	1276	724					
	1,576 - 1,880	1207	689					
	1,881 - 2,261	1138	648					
	2,262 - 2,413	1069	607					
AISI 316								
ASTM A313 ¹	0,051 - 0,584	1344	765	204	193053	X 5 CrNiMo 17-12-2	Z 7 CND 17-12-2	1,4401
	0,585 - 1,219	1310	745					
	1,220 - 1,549	1207	683					
	≥1,550	1172	669					
17-7 PH								
CONDITION CH900 AMS-5529	ALL	1655 ²	945 ²	343	203395	X 7 CrNiAl 17-7	Z 9 CNA 17-07	1,4568
A-286								
AMS-5810	ALL	1241 ²	724 ²	538	213737	X 6 NiCrTiMoVB 25-15-2	Z6NCTDV25-15	1,4980
INCONEL ⁵ Alloy X-750								
SPRING TEMPER AMS-5699 ³	ALL	1517 ²	862 ²	371	213737	NiCr 15 Fe 7 TiAl	NC 15 Fe 7 TA	2,4669
No. 1 TEMPER "Rc 35 MAXIMUM" AMS-5699 ^{1,3}	ALL	938 ² REF	531 ²	371				
No. 1 TEMPER AMS-5698	ALL	1069 ²	607 ²	538				
INCONEL ⁵ Alloy 718								
AMS-5596 ¹	ALL	1241 ²	703 ²	704	204085	NiCr 19 NbMo	NC 19 FeNb	2,4668
ELGILOY ⁵								
AMS-5876 ^{1,3}	≤ 0,102	2068 ²	1179 ²	427	206843	CoCr20 Ni16 Mo7	Not applicable	Not applicable
	0,103 - 0,483	1999 ²	1138 ²					
	0,484 - 0,635	1931 ²	1096 ²					
	0,636 - 2,54	1862 ²	1062 ²					
BERYLLIUM COPPER								
TEMPER TH02 ASTM B197 ¹	ALL	1276 ²	883 ²	204	127553	CuBe2	Not applicable	2,1247

NOTE: Additional materials available include Phosphor Bronze, C-276, 410 Stainless Steel, MONEL⁵ K-500, MONEL⁵ 400, Waspaloy and others. Please consult Smalley Engineering for further details.

¹ Referenced for chemical composition only.

² Values obtained after precipitation hardening.

³ Conforms to NACE Standard MR-01-75.

⁴ Exceeding these temperatures will cause increased relaxation. Consult Smalley Engineering for High Temperature applications.

⁵ ELGILOY is a registered trademark of Combined Metals of Chicago. INCONEL and MONEL are registered trademarks of Special Metals Corporation. HASTELLOY is a registered trademark of Haynes International.

Material Types

Selecting the proper material for an application requires a general knowledge of what is commonly available for use in Smalley flat wire products. Specifying the correct material can prevent additional cost and failure in operation. Carbon steel is the most commonly specified material. Stainless steels, although more costly than carbon steel, provide far superior corrosion resistance and have higher temperature operating limits.

Carbon Steel Oil Tempered

SAE 1070-1090 high carbon tempered spring steel is a standard material for spiral retaining rings and wave springs. Tensile strength and yield strength are maximized as a result of the oil tempered martensitic structure.

Hard Drawn

SAE 1060-1075 high carbon cold drawn spring steel is a standard material for snap rings. Hard drawn carbon steel has no scale as it receives its strength from the drawing process.

In either temper, carbon steel is best suited in applications having a protected environment as it corrodes if not lubricated or atmospherically sealed. Additional corrosion protection can be added with special finishes. Rings and springs are normally supplied with an oil dip finish providing protection during shipment and for shelf storage.

■ Carbon steel is highly magnetic and can be a variety of different colors including blue, black and gray.

Stainless Steel 302 Stainless Steel

302 is the standard stainless steel for spiral retaining rings. This widely used material is specified because of its combination of corrosion resistance and physical properties. 302 obtains its spring temper condition by cold working. Though it is categorized as being a nonmagnetic stainless, 302 becomes slightly magnetic as a result of cold working. It is not hardenable by heat treatment.

■ 302 has a silver-gray color.

316 Stainless Steel

Nearly identical in physical properties and heat resistance to 302, 316 provides additional corrosion resistance, particularly against pitting, due to its molybdenum chemical content. 316 is generally used in food, chemical and sea water applications.

316 shows less magnetism than 302. However, as with 302, magnetism increases as the wire is cold reduced. This stainless grade is also not hardenable by heat treatment.

■ 316 has a silver-gray color.

17-7 PH Condition CH900 Stainless Steel

Similar in corrosion resistance to type 302, this alloy is used almost exclusively for wave springs, yet offers both high tensile and yield strengths for special ring applications. In fatigue and high stress applications, 17-7 out performs even the finest grade of carbon steel.

Spring properties are achieved by precipitation hardening Condition C to Condition CH900. As a result, the material may be subjected to a temperature of 343°C without a loss of spring properties. 17-7 PH Condition CH900 exhibits magnetism similar to high carbon steel.

■ After precipitation hardening, 17-7 has a blue, brown or silver color as a result of open-air heat treatment, although atmosphere controlled heat treatment provides a bright color.

Super Alloys

Inconel X-750*

This nickel-chromium alloy is used most commonly in high temperature and corrosive environments. Two commonly specified tempers of Inconel are described below.

Most commonly, Inconel X-750 is precipitation heat treated to a spring temper condition. In this state, it has temperature resistance to 371°C. The National Association of Corrosion Engineers (NACE) approves this hard temper to specification MR-01-75 (Rc50 maximum) for spiral retaining rings and wave/compression springs.

#1 temper, which requires a longer heat treatment than spring temper, has a lower tensile strength but provides temperature protection to 538°C.

Both spring temper and #1 temper may be heat treated in either an open air or atmosphere controlled furnace. Open air heat treatment may produce oxidation, which often results in a slight black residue. An atmosphere controlled environment eliminates oxidation and produces a component with no residue.

- Rings and springs manufactured from this grade of Inconel have a blue/silver-gray color and exhibit no magnetism.



A286 Alloy

In applications up to 538°C, this alloy exhibits similar properties to Inconel X-750. Its spring temper condition is obtained by precipitation hardening. A286 may be heat treated similar to spring temper and #1 temper Inconel.

- This material exhibits no magnetism and has a blue/silver-gray color.

Elgiloy*

Known for its excellent resistance to corrosive environments and use at elevated temperatures, this relatively new spring material is now readily available from Smalley. Commonly used in oil industry applications, Elgiloy shows improved reliability over other NACE approved materials by resisting sulfide stress cracking. Additionally, Elgiloy is said to out perform "over 600% better than 17-7 PH in load retention at 343°C and provide over 100% more cycles (in fatigue resistance) than carbon steel, without breakage."

- Elgiloy exhibits no magnetism and is blue-brown in color as a result of heat treatment.

Coppers

Beryllium Copper Alloy #25

Normally specified in a hard temper, this alloy produces excellent spring properties due to a combination of low modulus of elasticity and high ultimate tensile strength. The alloy gains its physical properties by precipitation hardening. In contrast to other copper alloys, beryllium copper has the highest strength and offers remarkable resistance to loss of physical properties at elevated temperatures.

- Beryllium copper is nonmagnetic. Its electrical conductivity is about 2-4 times as great as phosphor bronze

Phosphor Bronze, Grade A

Phosphor bronze offers fair spring properties, fair electrical conductivity and is rated a step below beryllium copper in performance. It is purchased in a spring temper condition to maximize spring characteristics.

- Phosphor bronze is hardenable only by cold working. This material is also nonmagnetic.

*INCONEL X-750 is a registered trademark of Special Metals Corporation. ELGILOY is a registered trademark of Combined Metals of Chicago.

Material Finishes

Black Oxide

MIL-DTL-13924, Class 1

This finish provides a flat black finish. Black oxide is intended more for cosmetic appearance than for corrosion resistance.

Cadmium Plating

Cadmium Plate, AMS-QQ-P-416, Type I, Class 2,

Cadmium Plate w/Chromate Dip, AMS-QQ-P-416, Type II, Class 2

Cadmium plating is used on carbon steel to increase the corrosion resistance of the product. The process of cadmium plating spiral retaining rings is costly and subjects the ring to the possibility of hydrogen embrittlement. Smalley offers stainless steel as the preferable option to cadmium.

Oil Dip

This is the standard finish for all Smalley products produced from carbon steel.

The oil provides resistance to corrosion in transport and normal storage. The oil dip finish should not be considered a permanent finish.

Passivation

AMS 2700, Method 1, Type 2, Class 3

Passivation is an optional cleaning operation for stainless steel. It provides a bright finish and increased corrosion resistance. Passivation dissolves iron particles and other substances, which have become imbedded in the surface of stainless steel during production. If not dissolved, these foreign particles could promote rusting, discoloration or even pitting.

In theory, the corrosion resistance of stainless steel is due to the thin, invisible oxide film that completely covers the surface of the ring and prevents further oxidation. Removing the contaminants prevents breaks in the oxide film for optimum corrosion resistance.

Zinc Phosphate

MIL-DTL-16232, Type Z, Class 2

This finish is sometimes referred to as "Parkerizing" and appears gray-black in color. The corrosion resistance of phosphate is superior to black oxide but inferior to cadmium plating or stainless steel. Phosphate can not be applied to stainless steel.

Vapor Degrease/Ultrasonic Clean

This is the standard cleaning and finish for all stainless steels. The process removes oil and other organic compounds from the material surface by use of a chlorinated solvent. The solvent effectively removes oil and grease from the exposed surfaces of the ring or spring. Ultrasonics are used in forcing the solvent to act between the turns of the ring.

Vibratory Deburr/Hand Deburr

Though all circumferential surfaces and edges of Spirolox Rings are smooth, sharp corners are always present on the gap ends due to the cut-off operation. To break the sharp corners, achieving a blended/smooth surface finish, rings may either be vibratory or hand deburred to meet your specifications.

Specifications

Federal, aerospace and other regulating agencies have prepared several specifications for sheet and strip materials, but few have been published for flat wire. Smalley procures its material to internally generated specifications. In addition to controlling tensile strength, rigid inspection procedures have been established to check for edge contour, physical imperfections, camber, cross-section and chemical composition.

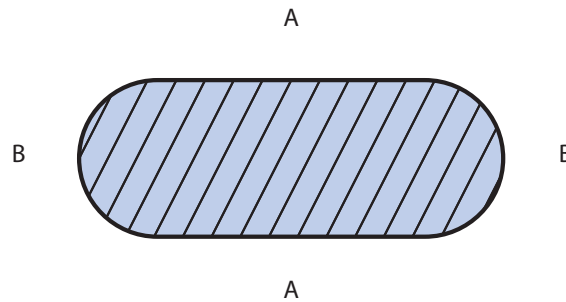

Ultimate Tensile Strength

To check the spring properties of wire, Ultimate Tensile Strength is the preferred test method over hardness because spring temper flat wire develops different hardnesses at various indentation points. As a result of cold rolling, the top and bottom surfaces ("A") become harder as they are more severely worked than the round edge areas ("B"). Tensile tests are more consistent as they evaluate the entire cross-section, not a single point as in a hardness test.



Spring Design Defining the Spring Requirements

Although wave spring applications are extremely diverse, there is a consistently basic set of rules for defining spring requirements. Those requirements are used to select a stock/standard spring or design a special spring to meet the specifications.

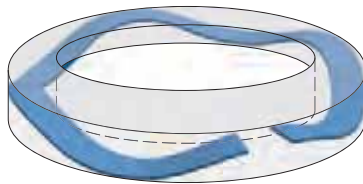

Working Cavity

The working cavity usually consists of a bore the spring operates in and/or a shaft the spring clears. The spring stays positioned by piloting in the bore or on the shaft. The distance between the loading surfaces defines the axial working cavity or work height of the spring.

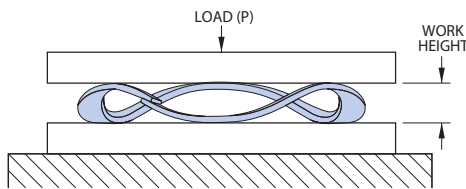

Load Requirement

The load requirement is defined by the amount of axial force the spring must produce when installed at its work height. Some applications require multiple working heights, where loads at 2 or more operating heights are critical and must be considered in the design. Often minimum and/or maximum loads are satisfactory solutions, particularly where tolerance stack-ups are inherent in the application.

Operating Environment

High temperature, dynamic loading (fatigue), a corrosive media or other unusual operating conditions must be considered in spring applications. Solutions to various environmental conditions typically require selection of the optimal raw material and operating stress.

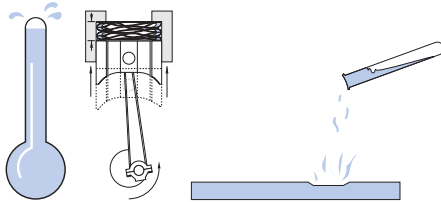

Standard Springs vs. Special Springs

Finding the right spring can be as easy as selecting a standard catalog item. A Smalley engineer can help you choose from over 4000 standard parts available from stock in carbon and stainless steel. Smalley's "no-tooling" method of manufacturing provides the utmost in flexibility and quality. Whether the requirement is for 1 spring or 1000000 consider Smalley for your special spring requirements.

Let Smalley Design Your Spring

Over 50% of Smalley's business is in the design and manufacturing of special springs to suit individual applications. Whether it's a technical question, or the most complex spring design, Smalley engineers are always available and welcome the opportunity to assist you. Utilize the Application Checklist found in this catalog. Or at www.smalley.com we provide a simple procedure to e-mail us your known design parameters. An engineer will recommend a standard catalog item or provide you with design options for a special spring.

Spring Design

Nomenclature

b	Radial Width of Material, mm [(O.D. - I.D.)÷2]	P	Load, N
D _m	Mean Diameter, mm [(O.D. + I.D.)÷2]	S	Operating Stress, N/mm ²
E	Modulus of Elasticity, N/mm ²	t	Thickness of Material, mm
f	Deflection, mm	WH	Work Height, mm (H-f)
H	Free height, mm	Z	Number of Turns
I.D.	Inside Diameter, mm		
K	Multiple Wave Factor, see Table 1		
L	Length, Overall Linear, mm		
N	Number of Waves (per turn)		
O.D.	Outside Diameter, mm		

Multiple Wave Factor (K)			
N	2,0-4,0	4,5-6,5	7,0-9,5
K	3,88	2,90	2,30

Table 1

Single Turn Gap or Overlap Type Applications

1. Low-Medium Force
2. Low-Medium Spring Rate
3. Short Deflection
4. Precise Load/Deflection Characteristics

Single turn wave springs are the basic and most common wave spring product. They are used in the widest variety of spring applications due to their lower cost and simplified design configuration.

Single turn wave springs provide the most flexibility to designers. There are few restrictions in their design. They are specified in the majority of small axial and radial space constraint applications.

Formulas:

$$\text{Deflection} = f = \frac{P K D_m^3}{E b t^3 N^4} * \frac{\text{I.D.}}{\text{O.D.}}$$

$$\text{Operating Stress} = S = \frac{3 \pi P D_m}{4 b t^2 N^2}$$

Example: Smalley Part Number SSB-0158

Calculate free height and operating stress for Smalley part number SSB-0158 (Gap Type, Single Turn, Carbon Spring Temper Steel).

Where:

P = 111,2 N
t = 0,46 mm
b = 3,63 mm
O.D. = 40,00 mm
I.D. = 32,74 mm
D _m = 36,37 mm
N = 3
E = 206843 N/mm ²
K = 3,88
WH = 1,98 mm

$$\text{Deflection} = f = \frac{(111,2)(3,88)(36,37)^3}{(206843)(3,63)(0,46)^3(3)^4} * \frac{32,74}{40,00} = 2,87 \text{ mm}$$

$$*\text{Free Height} = H = (\text{W.H.} + f) = 1,98 + 2,87 = 4,85 \text{ mm}$$

$$\text{Operating Stress} = S = \frac{(3)(\pi)(111,2)(36,37)}{(4)(3,63)(0,46)^2(3)^2} = 1378 \text{ N/mm}^2$$

*Calculated free height may not be the same as the actual springs measure due to variations in raw material and manufacturing process.

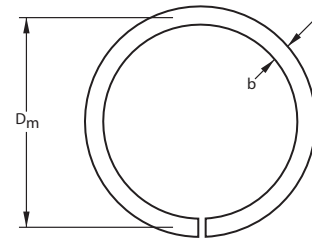

Crest-to-Crest (Series Stacked) Applications

1. Low-Medium Force
2. Low-Medium Spring Rate
3. Long Deflection
4. Precise Load/Deflection Characteristics

Crest-to-Crest flat wire compression springs are pre-stacked in series, decreasing the spring rate by a factor related to the number of turns.

Formulas:

$$\text{Deflection} = f = \frac{P K D_m^3 Z}{E b t^3 N^4} * \frac{\text{I.D.}}{\text{O.D.}}$$

$$\text{Operating Stress} = S = \frac{3 \pi P D_m}{4 b t^2 N^2}$$

Note:
N must be in 1/2 wave increments
Z = Number of active turns

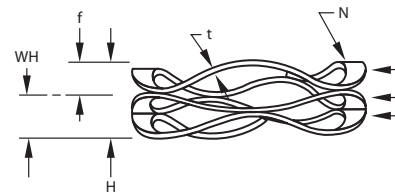
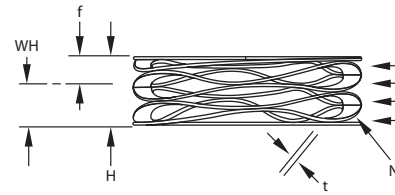

Nested Spirawave® (Parallel Stacked)

1. Higher Force
2. Higher Spring Rate
3. Short Deflection
4. Precise Load/Deflection Characteristics

Nested Spirawave Wave Springs are pre-stacked in parallel, increasing the spring rate by a factor related to the number of turns.

Formulas:

$$\text{Deflection} = f = \frac{P K D_m^3}{E b t^3 N^4 Z} * \frac{\text{I.D.}}{\text{O.D.}}$$

$$\text{Operating Stress} = S = \frac{3 \pi P D_m}{4 b t^2 N^2 Z}$$

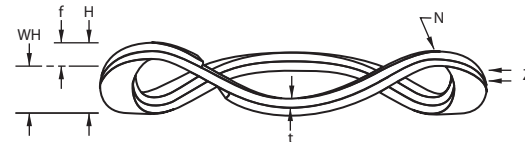

Diameter Expansion

Nested & Crest-to-Crest Spirawaves Only: Multiple turn Spirawaves expand in diameter when compressed. The formula shown below is used to predict the maximum fully compressed diameter.

Formula: Maximum outside diameter at 100% deflection (solid height) = $0,02222 * R * N * \theta + b$

Where:

- R = Wave Radius = $(4Y^2 + X^2) \div 8Y$
 - N = Number of Waves
 - θ = Angle, degrees = $\text{ArcSin}(X \div 2R)$
 - b = Radial Wall
 - X = 1/2 Wave Frequency = $\pi D_m \div 2N$
 - Y = 1/2 Mean Free Height = $(H-t) \div 2$
- Where H = Per Turn Free Height

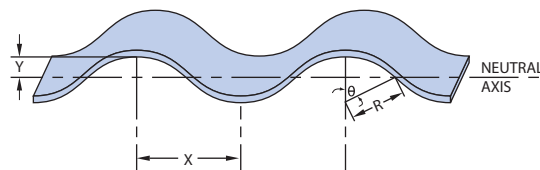

Linear Springs

Linear Springs are a continuous wave formed (marcelled) wire length produced from spring temper materials. They act as a load bearing device having approximately the same load/deflection characteristics as a wave spring.

Forces act axially or radially depending on the installed position. Axial pressure is obtained by laying the spring flat in a straight line. Circular wrapping the spring (around a piston for example) produces a radial force or outward pressure.

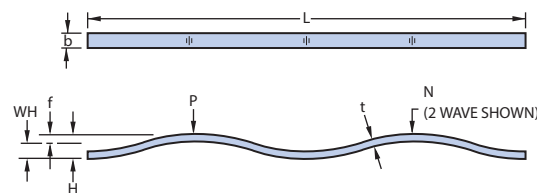

Formula: Single wave linear spring where N=1

$$\text{Deflection} = f = \frac{P L^3}{4 E b t^3} \quad \text{Operating Stress} = S = \frac{3 P L}{2 b t^2}$$

Formula: 2 or more wave linear springs where N>1

$$\text{Deflection} = f = \frac{P L^3}{16 E b t^3 N^4} \quad \text{Operating Stress} = S = \frac{3 P L}{4 b t^2 N^2}$$

Spring Design

Stress

Operating Stress

Compressing a wave spring creates bending stresses similar to a simple beam in bending. These compressive and tensile stresses limit the amount a spring can be compressed before it yields or “takes a set”. Although spring set is sometimes not acceptable, load and deflection requirements will often drive the design to accept some set or “relaxation” over time.

Maximum Design Stress

Static Applications Smalley utilizes the Minimum Tensile Strength found in this catalog’s Materials section to approximate yield strength due to the minimal elongation of the hardened flat wire used in Smalley products. When designing springs for static applications we recommend the calculated operating stress be no greater than 100% of the minimum tensile strength. However, depending on certain applications, operating stress can exceed the minimum tensile strength with allowances for yield strength. Typical factors to consider are permanent set, relaxation, loss of load and/or loss of free height.

Dynamic Applications When designing wave springs for dynamic applications, Smalley recommends that the calculation of operating stress not exceed 80% of the minimum tensile strength. Refer to the “Fatigue Stress Ratio” and Table 2 for further fatigue guidelines.

Residual Stress/Pre-Setting

Increasing the load capacity and/or fatigue life can be achieved by compressing a spring beyond its yield point or “presetting”. Preset springs are manufactured to a higher than needed free height and load and then compressed solid. Both the free height and load are reduced and the material surfaces now exhibit residual stresses, which enhance spring performance.

Fatigue

Fatigue cycling is an important consideration in wave spring design and determining precisely how much the spring will deflect can greatly impact the price of the spring. An analysis should include whether the spring deflects full stroke or only a few thousandths each cycle or possibly a combination of both as parts wear or temperature changes.

The fatigue guidelines in Table 2 provide a conservative approach and allow for calculation of cycle life between 2 work heights. Although these methods of fatigue analysis have proven to be a good approximation, testing is recommended whenever cycle life is critical.

Formula:

$$\text{Fatigue Stress Ratio} = X = \frac{(\sigma - S_1)}{(\sigma - S_2)}$$

(refer to Table 2)

Where: σ = Material tensile strength
 S_1 = Calculated operating stress at lower work height (must be less than σ)
 S_2 = Calculated operating stress at upper work height

Load/Deflection

A comparison of the actual spring rate to the theoretical (calculated) spring rate provides practical limits for the working range of the spring. Spring rate (P/f) can be calculated by manipulating the deflection equations. See formulas in the Spring Design section.

Figure 1 shows a graph of theoretical and tested spring rate. Typically, theoretical rate is accurate until the spring starts to bottom out or reach its “solid height”.

As a general rule, the calculated spring rate is linear through the first 80% of available deflection and for work heights down to 2 times the solid height. Although the spring can operate beyond this “linear” range, measured loads will be much higher than calculated.

X	Estimated Cycle Life
< 0,40	Under 30000
0,40 - 0,49	30000 – 50000
0,50 - 0,55	50000 – 75000
0,56 - 0,60	75000 – 100000
0,61 - 0,67	100000 – 200000
0,68 - 0,70	200000 – 1000000
> 0,70	Over 1000000

Table 2

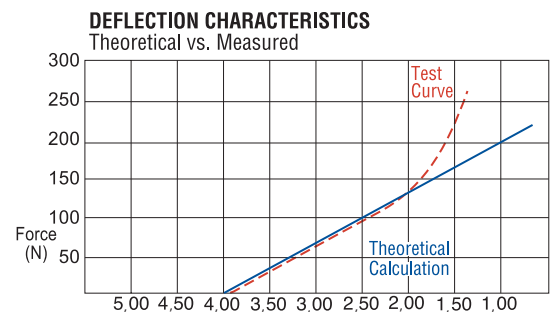

Figure 1

Hysteresis

Wave springs exert a greater force upon loading and lower force upon unloading. This effect is known as hysteresis. The shaded area shows a graphic representation between the curves in Figure 2.

In a single turn spring, friction due to circumferential and radial movements are the prime causes. Crest-to-Crest and Nested Springs also contribute to the frictional loss as adjacent layers rub against each other. Sufficient lubrication will minimize this effect.

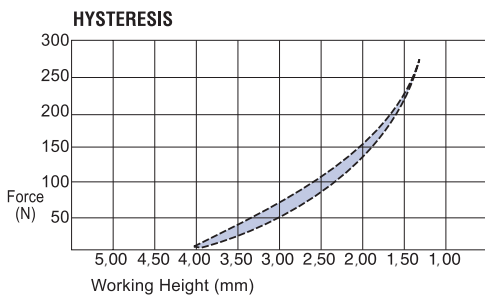

Figure 2

Design Guidelines

Material Cross-Section

Material cross-section plays an important role in wave spring design. The most economical materials are those used in manufacturing Smalley standard springs and retaining rings. In addition, many other material cross sections are commonly used in special spring manufacture designs. Smalley engineering can provide assistance in selecting an economical alloy and cross section.

As a basic guideline, use our standard 'SSR'-Wave Spring series for cross-section/diameter relationships. Lighter material sections are usually acceptable. Heavier sections for a given diameter may be incorporated using the following information:

Special wave spring design criteria for selecting material cross-sections:

Maximum material thickness = standard ('SSR-') thickness * 2

Maximum radial wall = material thickness (any value) * 10

Minimum radial wall = material thickness (any value) * 3

For Overlap Type Wave Springs and multiple turn Spirawaves, the radial wall must be sufficient to prevent misalignment between adjacent layers. For springs with a narrow radial wall, radial misalignment can occur during handling or during operation if the spring is not contained or closely piloted.

Solutions to this problem include dimensioning the spring to pilot closely on the I.D. and/or O.D. or designing the spring as a single turn Gap Type.

Diameters

Figure 3 illustrates two methods of specifying diameters. In either case, the spring diameter is developed to provide proper operation between the bore and the shaft.

Note: Smalley's manufacturing process of edgewinding controls either the O.D. or the I.D. The material radial wall is also tightly controlled. Therefore whenever possible, tolerance only one diameter and the radial wall instead of tolerancing both the O.D. and I.D.

Bore Pilot

For springs that pilot in the bore as shown in figure 3a, the bore and shaft diameters should be included in the spring specifications. Commonly used requirements would read:

"Spring must pilot and operate in a (minimum bore) bore diameter."

"Spring must clear a (maximum shaft) shaft diameter."

The actual spring diameter is then developed at time of manufacture to provide the best fit and prevent binding due to expansion.

For Gap Type and Overlap Type Springs, the outside diameter can be specified because binding is not a concern. The outside diameter can be toleranced to provide a minimum clearance in the bore or provide cling in the bore, as do the Smalley Bearing Preload Springs.

Shaft Pilot

For springs that pilot on a shaft as shown in Figure 3b, the inside diameter can be toleranced to provide a minimum clearance from the shaft. Since wave springs expand during compression, interference with the shaft is generally not a concern.

To insure proper operation, include shaft and bore diameters in the spring specifications. Commonly used requirements would read:

"Spring pilots over and clears a (maximum shaft) shaft diameter."

"Spring operates in a (minimum bore) bore diameter."

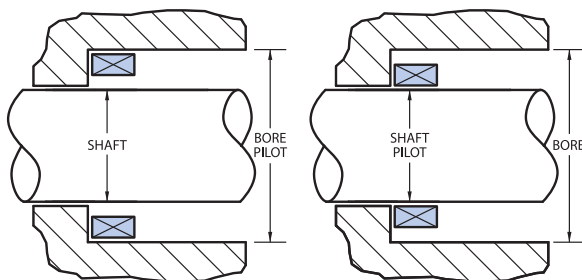

Figure 3a

Figure 3b

Engineering Design

Spirolox Retaining Ring and Constant Section Ring applications, although diverse, can be analyzed with a straight forward set of design calculations. There are four main areas that should be considered in most applications.

1. Material Selection
2. Load Capacity
3. Rotational Capacity
4. Installation Stress

Smalley Application Engineers are available to provide immediate technical assistance.

The following pages of Spirolox Retaining Ring and Constant Section Ring engineering design have been developed from over 50 years of extensive testing and research into the various applications of retaining rings. The formulas are provided for the preliminary analysis of a ring application and the design of a Spirolox Retaining Ring.

Design engineers commonly associate the word "retaining ring" to a basic style or type of retaining device. In reality, retaining rings are nearly as diverse as their applications. Spirolox Retaining Rings offer a distinct alternative, and in many instances an advantage, over the more common retaining rings available on the market today. Some of the major distinctions are:

Spiral Wound in Multiple Turns

Increases load capacity yet allows easy assembly by hand or as an automated process.

360° Retaining Surface

No gap – no protruding ears.

Diameters from 5 mm to 3000 mm

Uniform Radial Section

Provides a pleasant appearance on the assembled product. Beneficial when radial clearance is limited.

Simplified Assembly

Wind into groove. No special pliers/tools needed to install or remove. Removal notch provided for easy removal using a screwdriver.

Design Flexibility

Ring thickness can be changed to accommodate most any application by either varying material thickness and/or number of turns. Standard rings meet military and aerospace specifications. Special designs are produced quickly and economically in many alloys.

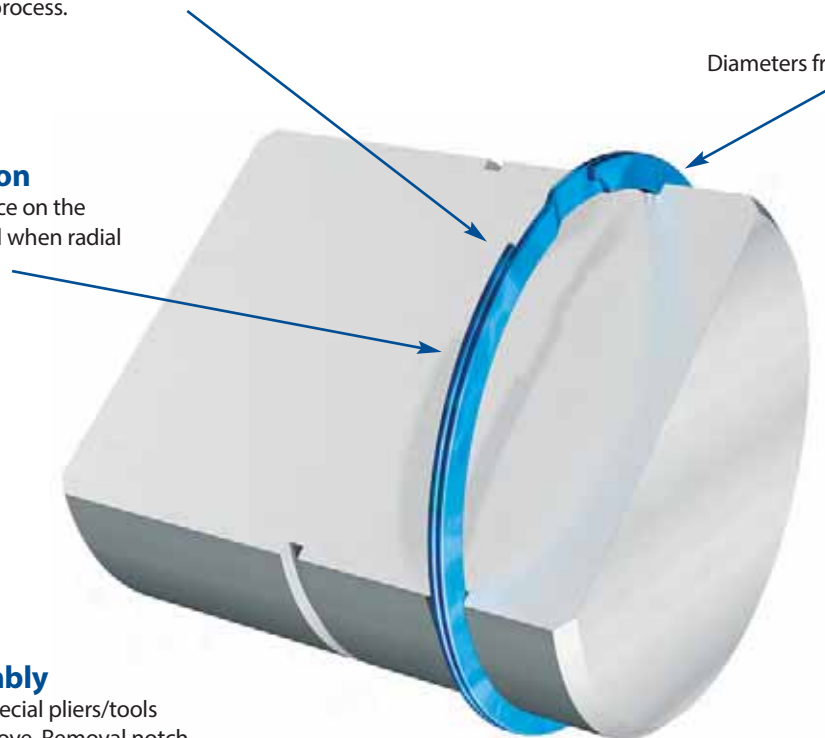

Load Capacity

Understanding the load capacity of a Spirolox Retaining Ring assembly requires calculations for both ring shear and groove deformation, with the design limitation being the lesser of the two.

The load capacity formulas do not take into account any dynamic or eccentric loading. If this type of loading exists, the proper safety factor should be applied and product testing conducted. In addition, the groove geometry and edge margin (i.e.; the distance of the groove from the end of the shaft or housing) should be considered.

When abusive operating conditions exist, true ring performance is best determined through actual testing.

Ring Shear

Although not commonly associated as a typical failure of Spirolox Retaining Rings, ring shear can be a design limitation when hardened steel is used as a groove material. Ring thrust load capacities based on ring shear are provided within this catalog's tables of standard rings. These values are based on a shear strength of carbon steel with the recommended safety factor of 3.

Formula:

$$P_R = \frac{DT S_S \pi}{K}$$

Where:

- P_R = Allowable thrust load based on ring shear (N)
- D = Shaft or housing diameter (mm)
- T = Ring thickness (mm)
- S_S = Shear strength of ring material (N/mm²)
- K = Safety factor (3 recommended)

Example:

1. EH-20-S02
2. Safety factor = 3

$$P_R = \frac{20,00 (0,89) 786 (\pi)}{3}$$

$$P_R = 14651 \text{ N}$$

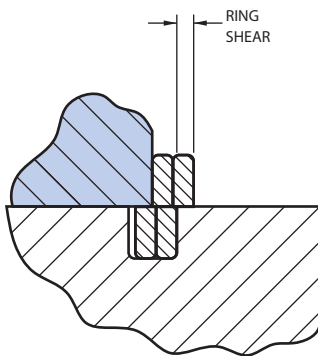

The thrust load based on ring shear above, must be compared to the thrust load based on groove deformation to determine which is the limiting factor in the design.

Groove Deformation (Yield)

Groove deformation is by far the most common design limitation of retaining rings. As permanent groove deformation occurs, the ring begins to twist. As the angle of twist increases, the ring begins to enlarge in diameter. Ultimately, the ring becomes dished and extrudes (rolls) out of the groove. As a conservative interpretation, the following equation calculates the point of initial groove deformation. This does not constitute failure which occurs at a much higher value. A safety factor of 2 is suggested. Ring thrust load capabilities based on groove deformation are provided within this catalog's tables of standard rings.

Formula:

$$P_G = \frac{D d S_y \pi}{K}$$

Where:

- P_G = Allowable thrust load based on groove deformation (N)
- D = Shaft or housing diameter (mm)
- d = Groove depth (mm)
- S_y = Yield strength of groove material (N/mm²), see Table 1
- K = Safety factor (2 recommended)

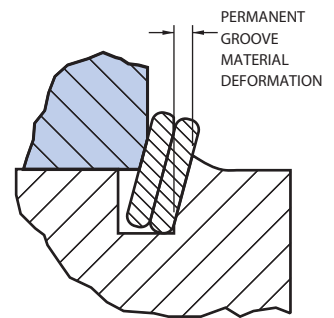

Example:

1. EH-20-S02
2. Groove material yield strength = 310 N/mm²
3. Safety factor = 2

$$P_G = \frac{20,00 (0,61) 310 (\pi)}{2}$$

$$P_G = 5941 \text{ N}$$

Typical Groove material yield strengths

Hardened Steel 8620	750 N/mm ²
Cold Drawn Steel 1018	500 N/mm ²
Hot Rolled Steel 1018	310 N/mm ²
Aluminum 2017	275 N/mm ²
Cast Iron	70-275 N/mm ²

Table 1

Since ring shear was calculated at 14651 N, the groove yields before the ring shears. Therefore 5941 N is the load capacity of the retaining ring.

Ring Design

Groove Geometry

Groove Radius

To assure maximum load capacity it is essential to have square corners on the groove and retained components. Additionally, retained components must always be square to the ring groove in order to maintain a uniform concentric load against the retained part. The radius at the bottom of the groove should be no larger than Table 2 states.

Shaft or Housing Diameter	Maximum Radius on Groove Bottom
25 mm and under	0,10 Max.
Over 25 mm	0,25 Max.

Table 2

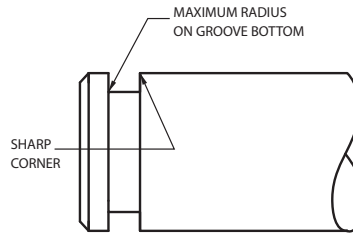

Retained Component

The retained part ideally has a square corner and contacts the ring as close as possible to the housing or shaft. The maximum recommended radius or chamfer allowable on the retained part can be calculated with the following formulas.

Where:

- b = Radial wall (mm)
- d = Groove depth (mm)

Example:

1. DNH-100

Maximum Chamfer = $0,375(6,05-1,61) = 1,61$ mm

Maximum Radius = $0,5(6,05-1,75) = 2,15$ mm

Formula:

Maximum Chamfer = $0,375(b - d)$
(on retained component)

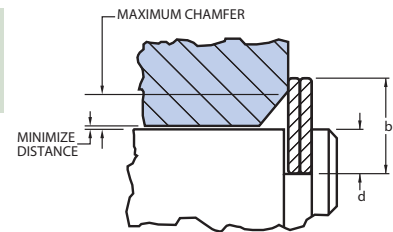

Formula:

Maximum Radius = $0,5(b - d)$
(on retained component)

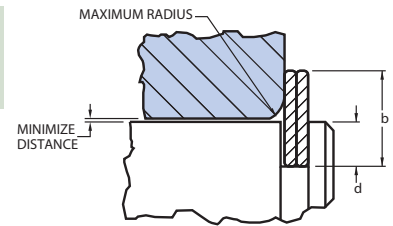

Edge Margin

Ring grooves which are located near the end of a shaft or housing should have an adequate edge margin to maximize strength. Both shear and bending should be checked and the larger value selected for the edge margin. As a general rule, the minimum edge margin may be approximated by a value of 3 times the groove depth.

Formula:

$$\text{Shear} \quad z = \frac{K 3 P}{S_Y D_G \pi}$$

$$\text{Bending} \quad z = \left[\frac{K 6 d P}{S_Y D_G \pi} \right]^{1/2}$$

Where:

- z = Edge margin (mm)
- P = Load (N)
- D_G = Groove diameter (mm)
- S_Y = Yield strength of groove material (N/mm²), Table 1
- d = Groove depth (mm)
- K = Safety factor (3 recommended)

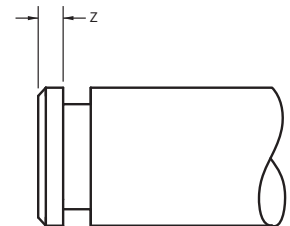

Example:

1. FS-040

2. Groove material yield strength = 310 N/mm²

3. Safety factor = 3

4. Load = 5000 N

Shear

$$z = \frac{3 (3) 5000}{310 (37,50) \pi}$$

$$z = 1,23 \text{ mm}$$

Bending

$$z = \left[\frac{3 (6) 1,25 (5000)}{310 (37,50) \pi} \right]^{1/2}$$

$$z = 1,76 \text{ mm}$$

Therefore the minimum edge margin that should be used is 1,76 mm

Rotational Capacity

The maximum recommended RPM for all standard external Spirolox Retaining Rings are listed in the ring tables of this manual.

A Spirolox Retaining Ring, operating on a rotating shaft, can be limited by centrifugal forces. Failure may occur when these centrifugal forces are great enough to lift the ring from the groove. The formula below calculates the RPM at which the force holding the ring tight on the groove (cling) becomes zero.

Rapid acceleration of the assembly may cause failure of the retaining ring. If this is a potential problem, contact Smalley engineering for design assistance.

Maximum RPM

Formula:

$$N = \left[\frac{3600 V E I g}{(4\pi^2) Y \gamma A R_M^5} \right]^{1/2}$$

- Where: N = Maximum allowable rpm (rpm)
 E = Modulus of elasticity (N/mm²)
 I = Moment of inertia = (t x b³) ÷ 12 (mm⁴)
 g = Gravitational acceleration (mm/sec²), 9810 mm/sec²
 V = Cling ÷ 2 = (D_G - D_I) ÷ 2 (mm)
 D_G = Groove diameter (mm)
 D_I = Free inside diameter (mm)
 Y = Multiple turn factor, Table 3
 n = Number of turns
 γ = Material density (N/mm³), (assume 7,68x10⁻⁵N/mm³)
 A = Cross sectional area = (t x b) - (0,12)t² (mm²)
 t = Material thickness (mm)
 b = Radial wall (mm)
 R_M = Mean free radius = (D_I + b) ÷ 2 (mm)

n	1	2	3	4
Y	1,909	3,407	4,958	6,520

Table 3

Example:

1. DNS-60

$$V = (D_G - D_I) \div 2 = (57,00 - 56,41) \div 2 = 0,30 \text{ mm}$$

$$I = (t \times b^3) \div 12 = (0,91 \times 5,08^3) \div 12 = 9,94 \text{ mm}^4$$

$$A = (t \times b) - (0,12)t^2 = (0,91 \times 5,08) - 0,12(0,91)^2 = 4,52 \text{ mm}^2$$

$$R_M = (D_I + b) \div 2 = (56,41 + 5,08) \div 2 = 30,75 \text{ mm}$$

$$N = \left[\frac{3600 (0,30) 206843 (9,94) 9810}{(4\pi^2) 3,407 (7,68 \times 10^{-5}) 4,52 (30,75)^5} \right]^{1/2}$$

N = 4119 rpm

Self-Locking

This feature allows the ring to function properly at speeds that exceed the recommended rotational capacity. The self-locking option can be incorporated for both external and internal rings. The self-locking feature utilizes a small tab on the inside turn "locking" into a slot on the outside turn. Self-locking allows the ring to operate at high speeds, withstand vibration, function under rapid acceleration and absorb a degree of impact loading.



Balanced

Smalley's balanced feature statically balances the retaining ring. A series of slots, opposite the gap end, account for the missing material in the gap. This characteristic is very useful when the balance of the assembly is critical and it is necessary to reduce eccentric loading.



Left Hand Wound

Smalley retaining rings are wound standard in a clockwise direction. In special applications it is sometimes favorable to have the retaining ring reverse, left hand wound.

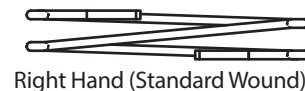

Right Hand (Standard Wound)

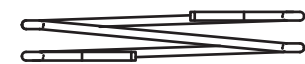

Left Hand (Reverse Wound)

Ring Design

Maximum Allowable RPM for Spirolox Retaining Rings — Metric

Part NUMBER	VSM	ES	DNS	FS	Part NUMBER	VSM	ES	DNS	FS	Part NUMBER	VSM	ES	DNS	FS	Part NUMBER	VSM	ES	DNS	FS	
6	51561	-	-	-	34	7398	7982	7763	10847	70	3402	2315	2982	4411	165	1000	795	753	1201	
7	39742	-	-	-	35	7004	7485	7628	11685	71	-	2309	-	-	170	945	749	715	1151	
8	40518	-	-	-	36	6641	6903	8474	11640	72	3218	2321	2805	3947	175	894	697	671	1088	
9	35627	-	-	-	37	-	7227	-	-	75	2949	2152	2537	3648	180	848	657	636	1030	
10	31833	-	-	-	38	5994	7174	7556	10520	77	-	-	2379	3467	185	898	631	601	1115	
11	25202	-	-	-	40	7573	6172	7181	10841	78	3158	2007	2304	3731	190	854	591	577	860	
12	30875	22153	-	-	42	6888	5715	6546	8972	80	3025	1981	2576	3747	195	813	569	551	880	
13	26805	20094	22915	31185	45	6021	5158	5740	7861	82	2900	1895	2425	3574	200	775	534	518	837	
14	22359	18471	19967	21602	46	-	4909	5505	7006	85	2703	1825	2333	3476	205	-	-	-	495	1068
15	19625	14543	17836	24273	47	-	5570	5283	7232	88	2526	1737	2143	3252	210	802	579	466	1077	
16	17364	14149	18132	29110	48	5309	5744	5075	7881	90	2443	1721	2029	2731	220	734	530	425	932	
17	14958	15923	15677	19841	50	4901	4084	5651	7885	92	-	-	-	-	230	674	482	527	854	
18	13439	12233	16195	22605	52	6057	3616	5251	7318	95	2174	1509	1777	2598	240	622	444	486	735	
19	12140	11685	14221	20417	53	-	3450	-	-	98	-	-	1659	2377	250	575	413	451	726	
20	11066	10810	12948	18532	54	-	3295	4842	6811	100	1955	1508	1579	2542	260	582	381	424	743	
21	15326	9641	12475	16896	55	5380	3360	4680	6576	102	-	-	1530	2746	270	541	354	390	718	
22	13341	10397	11421	13523	56	5238	3215	4525	6354	105	2082	1399	1435	2640	280	505	328	363	714	
23	-	9652	10495	14213	58	4890	3111	4359	5942	108	-	-	1368	2418	290	472	-	382	624	
24	11035	8479	10825	19083	59	-	2982	-	-	110	1902	1323	1391	2279	300	443	-	357	584	
25	10214	8524	10020	11982	60	4575	2862	4050	4793	115	1745	1248	1280	2090	310	-	-	342	-	
26	12483	8642	9301	12494	61	-	2683	-	-	120	1606	1176	1175	1694	320	-	-	316	-	
27	-	11357	8721	14320	62	4323	2884	3738	5490	125	1483	1092	1088	1778	330	-	-	299	-	
28	10648	10259	8609	15229	63	4220	2773	3691	5071	130	1374	993	1017	1647	340	-	-	343	-	
29	9973	9765	8060	18016	64	-	2780	-	-	135	1270	934	952	1530	350	-	-	322	-	
30	9534	9149	7562	12189	65	3967	2577	3430	4806	140	1186	870	888	1519	360	-	-	305	-	
31	-	8495	-	-	66	-	2526	-	-	145	-	821	835	1331	370	-	-	291	-	
32	8437	7778	8686	14215	67	-	2275	3239	4463	150	1022	755	788	1470	380	-	-	276	-	
33	-	-	8205	9511	68	3602	2486	3201	3945	155	961	891	733	1379	390	-	-	262	-	
					69	-	2438	-	-	160	1060	831	690	1296	400	-	-	251	-	

Maximum Allowable RPM for Spirolox Retaining Rings — Imperial

Part NUMBER	VS	WS	WST	WSM	FSE	Part NUMBER	VS	WS	WST	WSM	FSE	Part NUMBER	VS	WS	WST	WSM	FSE
25	45227	-	-	36651	-	146	-	5020	-	-	-	334	-	1840	1810	1960	-
31	39946	-	-	31364	-	150	5900	4940	4670	6540	12178	337	2630	1790	-	-	3433
37	31161	-	-	23025	-	156	7720	5343	5160	6110	9004	343	3500	1750	1690	1880	3334
43	24067	-	-	18019	-	157	-	5240	-	-	-	350	2440	1700	2020	2090	3236
46	-	-	28820	21450	-	162	7220	4880	4690	5750	9118	354	-	1730	1960	2080	-
50	28030	24650	20780	20600	32573	168	6590	4930	4110	5260	8595	356	2370	1680	-	1970	3528
56	-	-	-	-	32410	175	6200	4510	3930	4970	8101	362	2270	1660	1860	1890	2970
53	-	21280	-	-	-	177	-	4410	3960	4990	-	368	2210	1600	1860	1890	2890
55	-	19440	18130	18260	-	181	5700	4290	4170	4720	8470	374	-	1520	-	-	-
56	21060	18520	17270	17400	-	187	5380	4240	3850	4540	6440	375	2120	1530	1790	1860	2964
59	-	17290	15200	15390	-	193	5100	4020	-	-	8047	381	2060	1470	-	-	2701
62	17850	19500	15700	14730	22107	196	-	3860	3320	4730	-	387	2010	1500	1620	1750	2934
65	-	16270	-	-	-	200	4720	3740	3410	4560	7650	393	1930	1510	1560	1690	2529
66	-	16510	15600	13860	-	206	5970	3550	3340	3810	7103	400	1880	1470	1560	1660	2264
68	15340	15470	15600	13510	19520	212	5550	3400	3120	3560	6603	406	-	1400	-	-	-
71	-	13050	-	-	-	215	-	3490	3120	3450	-	412	2090	1350	-	-	2367
75	12350	14290	12750	12190	22451	216	-	3370	-	-	-	413	-	1380	-	-	-
78	-	12960	11590	11110	-	218	5290	3290	-	-	6316	418	-	1360	-	-	-
81	15380	12470	11300	10150	17414	225	5050	3220	2820	3240	6040	425	1960	1360	1350	1440	2350
84	-	10770	-	-	-	231	4720	3020	2730	3040	5786	431	-	1300	-	-	-
87	12800	10570	10660	10340	17374	236	-	2870	-	-	-	433	-	1300	-	-	-
90	-	9180	-	-	-	237	4520	2890	2560	3380	6343	437	1850	1290	1250	1360	2215
93	11500	9400	9100	8760	12757	243	4240	2920	2480	3180	5089	443	-	1230	-	-	-
96	-	8920	-	-	-	250	4063	2750	3040	3090	4994	450	1750	1270	1210	1300	2116
98	-	9530	6980	8640	-	255	-	2600	3430	2920	-	456	-	1280	-	-	-
100	9800	9160	7800	8940	18675	256	3900	2600	-	-	5118	462	1670	1240	-	-	2001
102	-	9070	7400	8500	-	262	3680	2500	2780	2750	4073	468	-	1220	-	-	-
103	-	8080	-	-	-	268	3540	2470	2630	2680	4797	472	-	1180	-	-	-
106	11490	8610	8660	11260	11446	275	3400	2340	2560	2790	3981	475	1580	1180	1160	1180	2193
109	-	7350	-	-	-	281	3220	2380	-	-	4074	481	-	1140	-	-	-
112	9990	7470	7960	9820	12107	287	3100	2260	2260	2590	3927	487	1520	1120	-	-	1816
115	-	6700	-	-	-	293	2940	2140	2200	2460	3727	493	-	1090	-	-	-
118	9220	7350	6320	9040	15056	295	-	2160	-	-	-	500	1440	1050	1020	1080	1724
121	-	6340	-	-	-	300	2840	2080	2150	2410	3537	511	-	1000	-	-	-
125	8500	6750	6500	8042	11970	306	3670	2020	2090	2290	3245	512	-	1020	-	-	-
128	-	5860	-	-	-	312	3030	1980	1990	2240	3853	525	1310	970	1280	1210	-
131	7880	6310	5800	8280	13786	314	-	1980	-	-	-	537	-	900	-	-	-
134	-	5960	-	-	-	315	-	-	1990	2190	-	550	1190	890	1170	1120	-
137	7030	6110	6000	7430	11008	318	2930	1930	-	-	3731	551	-	870	-	-	-
140	-	5580	-	-	-	325	2790	1870	1900	2100	3557	562	-	840	-	-	-
143	6560	5490	5160	6700	11594	331	2700	1840	-	-	3595	575	1090	820	1100	1030	-

Installation Stress Analysis

The equations provided are used to check that the elastic stress limit of the ring material is not exceeded by stress due to installation. Standard parts that are assembled manually in the recommended shaft/bore and groove diameters do not require stress analysis. Special rings, or rings being assembled with special tooling, require stress analysis.

To select a safe stress value, it is necessary to estimate the elastic limit of the raw material. The minimum tensile strength, as shown in the materials table of the catalog, can be used as a suitable estimate. As with any theoretical calculation, a closer analysis of the actual application may reveal that these stress values can be exceeded. However, particular consideration must be made to functional characteristics such as installation method, the number of times the ring will be installed and removed, thrust load and/or centrifugal capacity.

After forming, the ring's natural tendency is to return to its original state. This places the inner edge of the radial wall in residual tension and the outer edge in residual compression. To account for the residual stress in the ring when expansion is taking place, only 80% of the minimum tensile strength should be used to compare to the installation stress; see Table 4.

In special designs, where the installation stress exceeds the material's elastic limit, rings can be produced to diameters which will yield a predetermined amount during assembly. Once installed, the ring will have the proper cling (grip) on the groove.

Installation Stress

Formula:

For external rings

$$S_E = \frac{E b (D_S - D_I)}{(D_I + b)(D_S + b)}$$

For internal rings

$$S_C = \frac{E b (D_O - D_H)}{(D_O - b)(D_H - b)}$$

Where:

- S_E = Stress due to expansion (N/mm²)
- S_C = Stress due to compression (N/mm²)
- E = Modulus of elasticity (N/mm²)
- b = Radial wall (mm)
- D_S = Shaft diameter (mm)
- D_H = Housing diameter (mm)
- D_I = Free inside diameter, minimum (mm)
- D_O = Free outside diameter, maximum (mm)

Application	Percent of Minimum Tensile Strength
Shaft	80%
Housing	100%

Table 4

Example: Compare theoretical installation stress to percent of minimum tensile strength.

1. ES-20-S02

$$S_E = \frac{193053 (1,65) (20,00 - 18,62)}{(18,62 + 1,65)(20,00 + 1,65)}$$

$$S_E = 1002 \text{ N/mm}^2$$

Minimum tensile strength of the ring material: 1448 N/mm².
Using 80%, (Table 4), of 1448 N/mm² = 1158 N/mm².

$$1002 \text{ N/mm}^2 < 1158 \text{ N/mm}^2$$

Since the installation stress is less than 80% of the minimum tensile strength, permanent set is not expected.

End Configurations

Smalley offers 4 series of Eaton style snap rings from stock. Additional end types can be manufactured to meet your snap ring requirements. Inquire about the following end types:

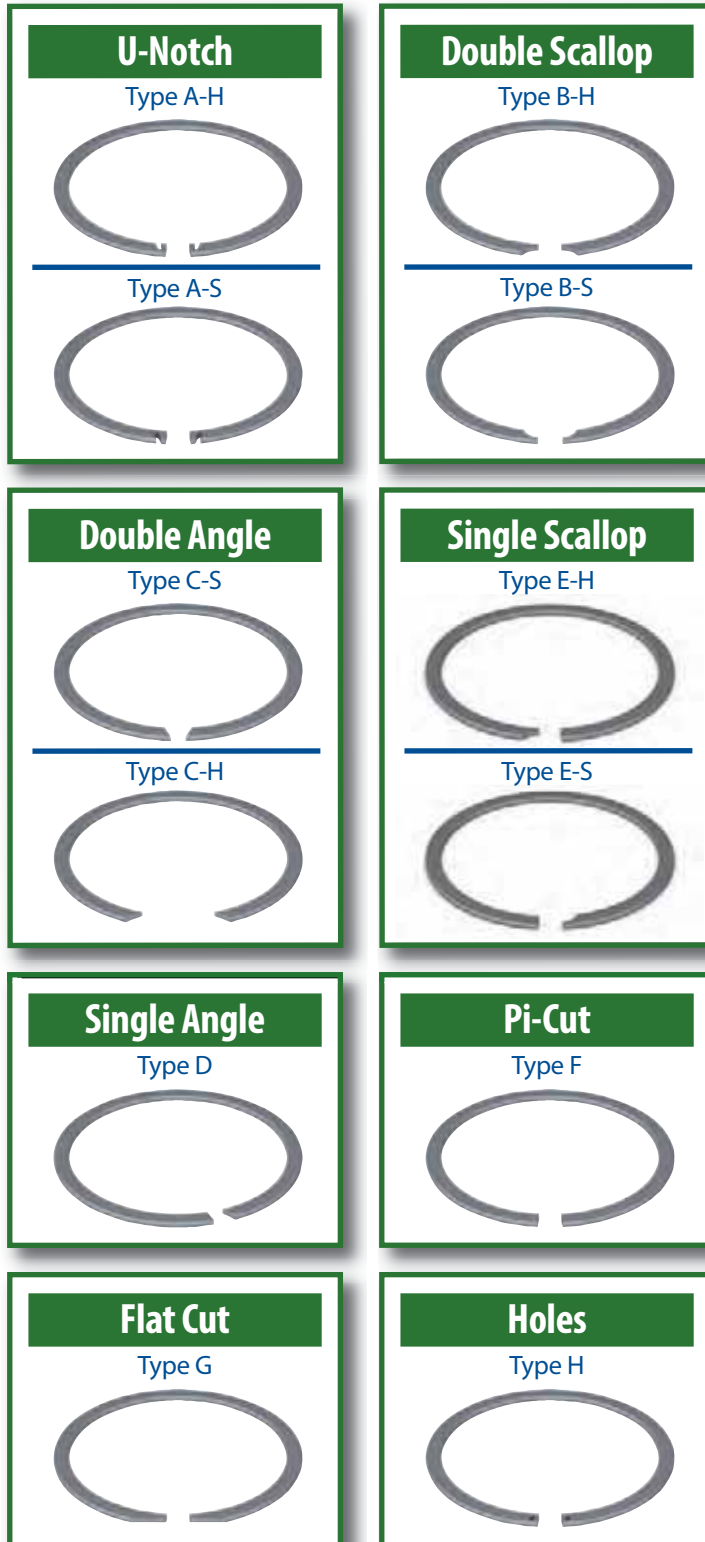

Material Hardness

Thickness (mm)	Hardness (Rc) Min.
Up to 0,56	46,0
Over 0,56 to 1,27	44,0
Over 1,27 to 1,98	42,0
Over 1,98	40,0

Ring Abutment

Unlike a conventional Spiral Retaining Ring or Snap Ring, the retained component in a Hoopster® Retaining Ring* assembly may have a corner break. Thrust load is not sacrificed when the retained component has a broken corner because the moment arm is negligible in a Hoopster design.

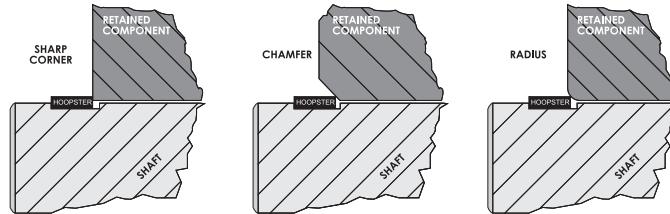

The 3 sketches above illustrate acceptable abutment practice.

Groove Design and Geometry

Groove deformation is by far the most common design limitation of most retaining rings. Unlike a conventional retaining ring or snap ring that fails by deforming and twisting, the Hoopster Retaining Ring shows superior strength from its low profile and mechanical advantage over traditional retaining rings under load. With a Hoopster, there is no moment arm that twists the ring causing premature failure as with a conventional retaining ring.

The shallow groove specification of a Hoopster makes the groove wall a critical specification, to ensure the function of the ring. To obtain maximum load capacity from a Hoopster Retaining Ring, it is essential to have sharp corners on the groove. The maximum radius on the groove bottom should be no greater than 10% of the ring's radial wall. Maintaining a sharp corner on the top of the groove is just as critical.

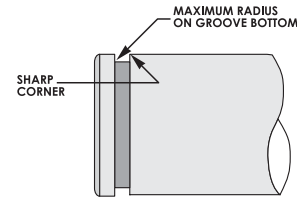

Formula: Maximum Radius on Groove Bottom = .10b

Where: b = Ring radial wall

Thrust Capacity

The shallow groove depth associated with a Hoopster, in combination with the groove material, are the controlling factors in determining thrust capacity. The Hoopster does not twist when loaded so pure thrust load based on the yield strength of the groove material maximizes the Hoopster's load carrying capacity.

Formula:

$$P_G = \frac{D d S_y \pi}{K}$$

Where:

- P_G = Allowable thrust load based on groove deformation (N)
- D = Shaft or housing diameter (mm)
- d = Groove depth (mm)
- S_y = Yield strength of groove material (N/mm²)
- K = Safety factor (2 recommended)

Typical Groove Material Yield Strengths

Hardened Steel 8620	758,42 N/mm ²
Cold Drawn Steel 1018	482,63 N/mm ²
Hot Rolled Steel 1018	310,26 N/mm ²
Aluminum 2017	275,79 N/mm ²
Cast Iron	0,69 - 275,79 N/mm ²

Table 5



*PATENT PENDING

www.smalley.com

Smalley's website is an interactive useful tool designed to help engineers and buyers find the product information needed. Here is a small sample of the resources available:

Product Search

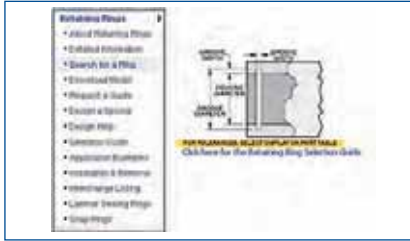
With numerous different product lines, it can be difficult to find the standard part that is best for an application. To simplify the selection of stock items, utilize Smalley's search tools.

Retaining Ring Search: www.smalley.com/retaining_rings/search_for_a_ring.asp	Wave Spring Search: www.smalley.com/wave_springs/search_for_a_spring.asp
	
<p>Smalley has over 6000 retaining rings to select from. Searching for the right ring is easy. Simply enter the application parameters and a list of corresponding rings will be presented to select from. A ring search allows the user to view the dimensions of all the rings for comparison.</p>	<p>Selecting the appropriate wave spring for an application can be a challenge. To simplify the process and differentiate between 4000 stock springs is easy. By searching online, only the springs that fit a particular application will be presented. This makes it easy to see the variety of spring configurations available.</p>

Online Design

To simplify the design process and assist with the selection and design of spiral retaining rings and wave springs, a number of tools are available to assist with part selection, designing a special and receiving design assistance.

Engineering Specs

With the complete dimensions of all standard parts available online, it is simple to view the specifications of the stock items applied to your application.

Retaining Ring Example: Modify the groove material to match your assembly and calculate the new thrust capacity.

Wave Spring Example: Substitute your actual work heights and generate the new loads and cycle life for a standard spring.

Design Your Own Ring or Spring

Smalley's website offers users the ability to configure their own retaining ring or wave spring. Enter the application requirements to design a custom part that can be manufactured to your specifications. Change the material, the operating cavity and the wire properties to see how your design is affected. Print or submit your design directly to Smalley to verify that your design will work. This useful tool can be found at:

Retaining Ring Design: www.smalley.com/retaining_rings/design_a_special.asp

Wave Spring Design: www.smalley.com/wave_springs/design_a_special.asp

Design Assistance

If you would like Smalley's assistance in specifying a retaining ring or wave spring for your application, simply fill out an application checklist and specify the known parameters. Smalley will work with you to determine if a stock item can be provided or if a special design is required. Requests can be submitted online or print the application checklist and fax it back to us.

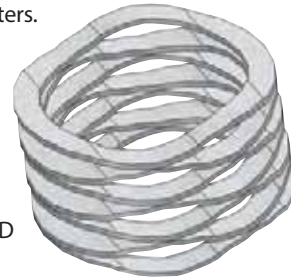

CAD Downloads

Standard retaining rings and wave springs are available for download in all major CAD systems. Once a part number has been selected an option to download a CAD model is presented. After a few simple steps, the model is available for direct download. This powerful CAD tool simplifies the design process by allowing engineers to drop Smalley parts right into any application.

With recently expanded capabilities, it is simple to adjust the operating heights of a wave spring model. Download a spring at either its posted work height, free height or enter a height at which the spring is expected to operate.



Request FREE Samples

Requesting samples to test in an application could not be easier. At www.smalley.com/samples, or on page 130 of this catalog, free samples of any standard catalog item can be requested at any time. Sample requests can be submitted and processed in 24 hours.

Additional Information

Assembly Information:

www.smalley.com/retaining_rings/installation_and_removal.asp

Detailed information on the various methods of assembling spiral retaining rings for high volume and low volume production is provided; includes both automated and manual assembly methods and an 18 page assembly brochure (www.smalley.com/pdfs/spiral_retaining_ring_install_and_removal.pdf).

Smalley News:

www.smalley.com/whats_new/whats_new.asp

As new products and applications are developed, Smalley's website is regularly updated with the latest information. Stay up to date with Smalley and find out What's New and how Smalley products are continuously evolving to meet new manufacturing standards.

Ask the Expert:

www.smalley.com/ask_the_expert/ask_the_expert.asp

Do you have a question that you would like to ask our staff? Questions submitted through "Ask the Expert" are routed directly to the appropriate department and will be promptly answered within 1 business day.

Smalley's engineering department provides free design consultation. Engineers are available to assist with part selection, custom designs, application requirements, materials, and more.

Get Catalog:

www.smalley.com/getcatalog

Need a new catalog or want to make sure you have the latest information? Smalley will promptly send out a copy of our latest catalog. Additionally, a PDF copy of Smalley's latest catalog is always available for download.

Springs Checklist

Application Checklist

Smalley Wave Springs

Custom Orders...Our Specialty

Fax to: +1 847 719 5999

Quick Delivery on Custom Orders • No-Tooling-Cost • Precise Specifications • Engineering/Design Assistance
Complete this application checklist and challenge Smalley's Engineering staff.

Name _____ Title _____ Date _____

Company _____

Address _____

City/State/Zip Code _____ Country _____

Phone _____ Fax _____

Email _____

Dimensions In: () Metric Units () Imperial Units

Operates in _____ bore diameter

Inside diameter clears _____ shaft

Specify which diameter the spring should pilot closest to:

() Bore () Shaft

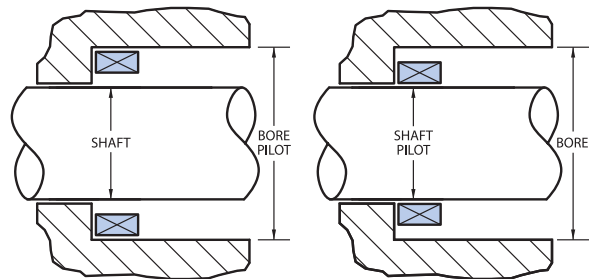

Load Deflection (Select One)

Group A

Min - Max Load @ Work Height () N @ mm () lb @ in

Free Height _____ Approximate

Group B

Min - Max Load @ Work Height () N @ mm () lb @ in

Min - Max Load @ Work Height () N @ mm () lb @ in

Free Height _____ Approximate

Group C

Free Height _____ (min) — _____ (max)

of Waves _____ Material Thickness _____

Radial Wall _____

Sketch

*Denotes standard material or finish.

Material

Consider the environment:
Temperature _____ °
() C () F

Corrosive Media _____

*Carbon Steel ()

*17-7 PH Stainless ()

302 Stainless Steel ()

316 Stainless Steel ()

Inconel X-750 ()

Other _____ ()

Finish

* Oil dipped ()
(Carbon Steel)

* Vapor degreased ()
and ultrasonic cleaned
(Stainless Steel)

Passivate ()

Black Oxide ()

Phosphate Coat ()

Vibratory Deburr ()

Other _____ ()

Fatigue: Specify estimated cycle life

() Static Application () 10⁶ Cycle Life

() Under 10⁵ Cycle Life () Over 10⁶ Cycle Life

() 10⁵ Cycle Life

Quantity: Prototype _____

Production _____

Application: (Description)

Application Checklist

Custom Orders...Our Specialty

Fax to: +1 847 719 5999

Rings Checklist

Quick Delivery on Custom Orders • No-Tooling-Cost • Precise Specifications • Engineering/Design Assistance
Complete this application checklist and challenge Smalley's Engineering staff.

Name _____ Title _____ Date _____
 Company _____
 Address _____
 City/State/Zip Code _____ Country _____
 Phone _____ Fax _____
 Email _____

Dimensions In: () Metric Units () Imperial Units

Housing Diameter _____
 Shaft Diameter _____
 Groove Diameter _____
 Groove Width _____
 RPM _____

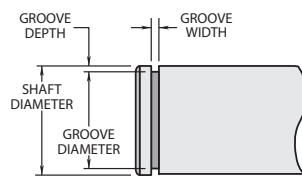

Ring Radial Wall _____

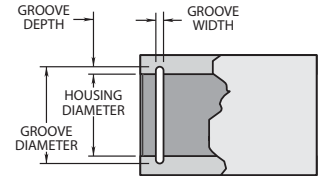

Ring Thickness _____

Thrust Capacity

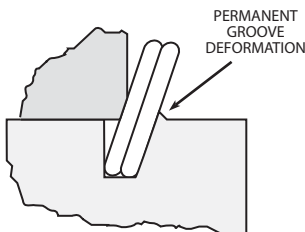

1. Groove Deformation

Occurs when maximum capacity is limited by the groove material (groove material is soft)

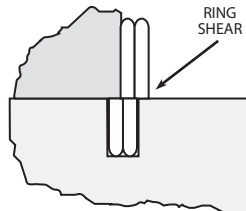

2. Ring Shear

Occurs when maximum capacity is limited by the retaining ring (groove material is hardened)

If thrust is a consideration specify:

Groove Material _____

Load Capacity _____ () N () lb

Sketch

*Denotes standard material or finish.

Material

Consider the environment:
 Temperature _____ °
 () C () F
 Corrosive Media _____
 *Carbon Steel ()
 *302 Stainless Steel ()
 *316 Stainless Steel ()
 Inconel X-750 ()
 A-286 ()
 Other _____ ()

Finish

* Oil dipped ()
 (Carbon Steel)
 * Vapor degreased ()
 and ultrasonic cleaned
 (Stainless Steel)
 Passivate ()
 Black Oxide ()
 Phosphate Coat ()
 Vibratory Deburr ()
 Other _____ ()

Quantity: Prototype _____
 Production _____

Application: (Description)

GO TO WWW.SMALLEY.COM/SPECIALS

How To Order

Specifying Smalley Part Numbers

Smalley ring and spring part numbers consist of three steps. Please use the following guide to correctly identify your part number:

WHT-50-PA-S02

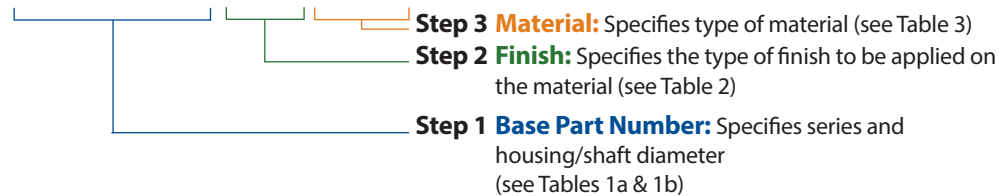

Step 1: Base Part Numbers

Select Series...

TABLE 1a: Retaining Ring Series

SERIES	# TURNS	INTERNAL	EXTERNAL
Light Duty	1	VHM	VSM
Light Duty*	1	VH	VS
Medium Duty*	2	WH	WS
Medium Heavy Duty*	2 or 3	WHT	WST
Heavy Duty	2	WHM	WSM
Constant Section	1	FH	FS
Constant Section (Eaton Style)*	1	XAH	XAS
Constant Section (Eaton Style)*	1	XDH	XDS
Aerospace	2	EH	ES
DIN Series	2	DNH	DNS
Constant Section*	1	FHE	FSE
Hoopster	1	HHM/HHMU	HSM
Hoopster*	1	HH/HHU	HS
WaveRing*	2	WHW	WSW

* Imperial Series

TABLE 1b: Wave Spring Series

SERIES	PREFIX
Bearing Preload	SSB
Standard Single-Turn*	SSR
Narrow Section Single-Turn*	SSR-N
Shim*	SSRS
Crest-to-Crest	CM
Crest-to-Crest with Shim End	CMS
Crest-to-Crest*	C
Crest-to-Crest with Shim End*	CS
Wavo*	RW

* Imperial Series

Then Specify Part Diameter

See the product tables for a complete listing of available diameters in stock. Below are some base part number examples:

VHM-25	25 mm Light Duty Internal Ring
FS-50	50 mm Constant Section Ring
CM10	10 mm Crest-to-Crest Wave Spring
CMS20	20 mm Crest-to-Crest Wave Spring w/Shim Ends
RW-0237	2,375" Wavo Spring

2 Step 2: Finish

To prevent corrosion, carbon steel has an oil dip finish. Stainless steel parts are vapor degreased and go through an ultrasonic cleaning process. To specify a special finish on retaining rings or wave springs add the appropriate suffix to the part number preceding the material suffix. For standard materials, there is no designation necessary.

TABLE 2: Finish

STANDARD		SPECIAL	
Finish	Designation	Finish	Designation
Carbon Steel — Oil Dip	None	Passivation	PA
Stainless Steel — Vapor Degrease & Ultrasonic Clean	None	Black Oxide	BA
		Phosphate Coat	PS
		Cadmium Plate	CD
		Vibratory Deburr	DV

Example: WH-100-**PA**-S02 1.000" Medium Duty Housing Ring, with **passivation** in 302 stainless steel

3 Step 3: Material

To specify the material, add the appropriate designation below to the end of the part number.

TABLE 3: Material

STANDARD		SPECIAL	
Finish	Designation	Finish	Designation
Carbon Steel SAE 1070-1090	None	Inconel X-750	INX
302 Stainless Steel (Retaining Rings)	S02	A286	A86
316 Stainless Steel (Retaining Rings)	S16	Beryllium Copper	BEC
17/7 PH Stainless Steel (Wave Springs)	S17	Phosphor Bronze	PHB
		Elgiloy	LGY

Examples: VHM-50 50 mm Light Duty Housing Ring in **Carbon Steel**
 VSM-100-**S02** 100 mm Light Duty Shaft Ring in **302 Stainless Steel**
 CM15-M5-**INX** 15 mm Crest-to-Crest Wave Spring in **Inconel X-750**

Note: Custom wave springs can be manufactured in 302 & 316 stainless steel, retaining rings can be manufactured in 17-7 PH stainless steel upon request.

Packaging

Smalley has the flexibility to package retaining rings and wave springs using a variety of methods to simplify your assembly process. Standard packaging is based on the diameter. As a general rule for both retaining rings and wave springs:

- 34 mm and under diameters are bulk packaged.
- 35 mm and over diameters are generally tube (coin) packaged in lengths 250 mm to 450 mm.

Placing An Order

Smalley customer service representatives are available to assist you and guide you through the ordering process. For standard catalog rings and springs, Smalley's customer service department can assist with pricing, ordering and delivery information. Contact Smalley customer service at:

+1 847 719 5900

+1 847 719 5999

sales@smalley.com

Bore Diameter: (See housing diameter)

Centrifugal Capacity (N): A mathematical expression for determining the speed (in revolutions per minute, rpm) at which a retaining ring will loose cling on the groove.

Cling: A value that signifies the amount of “interference fit” between a retaining ring and its groove.

Crest-To-Crest: Term used to identify a Smalley Flat Wire Compression spring in a “Series” configuration, having a sinusoidal waveform. The wave contour in each 360° turn provides a peak to valley relationship that decreases spring rate proportionally to the number of turns.

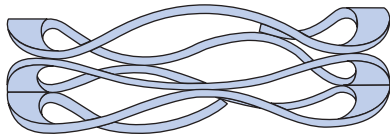

Dish: This ring dimension is the height difference in the ring cross section’s axis of symmetry between O.D. and I.D. as illustrated below:

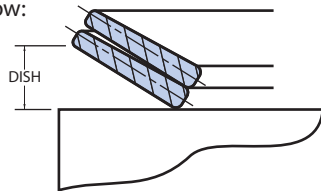

Edgewinding: Smalley’s manufacturing method of circle coiling rectangular section flat wire on edge.

Free Gap: The distance between the “Free Ends” of a ring or spring as it rests in its free state.

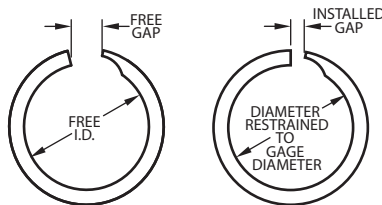

Hardness: The resistance of a material to plastic deformation, usually by indentation.

Helix: (see pitch)

Hoopster: Term used to identify the style of retaining ring with minimal radial projection and shallow groove depth.

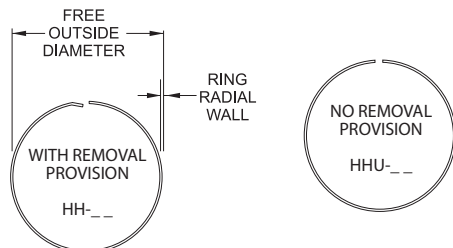

Housing Diameter (D_H): Also referred to as “bore” diameter. This dimension represents the inside diameter of the assembly where an internal retaining ring is installed.

Hydrogen Embrittlement: A condition where hydrogen is absorbed within the internal grain structure of metal tending to make it susceptible to cracking and failure, particularly under sustained loads. Environments such as hydrogen sulfide (H_2S) or processes such as electroplating or pickling can induce hydrogen embrittlement.

Installed Gap: (see Free Gap) This ring dimension is the distance between the ring ends while the ring is restrained at a specific gage diameter. Recommended as a more precise method of control over a free gap.

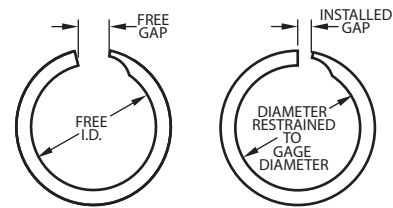

Installation Stress (S_C) or (S_E): Mathematical expression based on a radial strain. Useful in determining how far a Spirolox Retaining Ring can be expanded or contracted during installation.

Keystone: Derived from the definition of a “wedge” shaped stone. This term, illustrated below, refers to the “wedge” shaped cross section as a result of edgewinding flat wire.

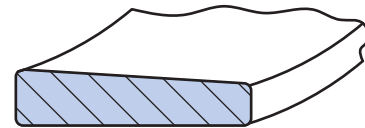

Left Hand Wound: Also referred to as “reverse wound”, design term signifying the counter-clockwise winding direction of a pitched coil.

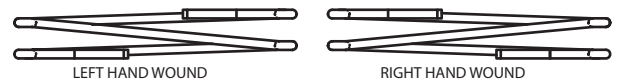

Linear Spring: Term used to identify a straight length of flat wire having a sinusoidal waveform. Used as a compression spring in both axial and radial applications.

Material Thickness (t): Also referred to as “wire” thickness. This dimension, as illustrated below, is useful in determining the overall ring thickness.

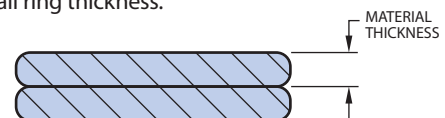

Misalignment: Also referred to as “skew”, this ring dimension is the radial variance of a multiple turn retaining ring.

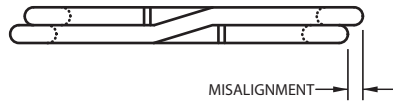

Modulus of elasticity (E): A measure of the rigidity of a material.

Nested: Term used to identify a Smalley Flat Wire Compression Spring in a “Parallel” configuration, having a sinusoidal waveform. The wave contour in each 360° turn matches (nests), increasing the spring rate proportionally to the number of turns.

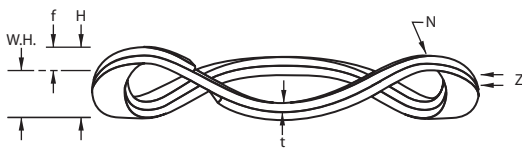

Number of Turns (n): The number of 360° turns of flat wire formed in a retaining ring or wave spring.

Offset: As illustrated below, this design feature is a bend in the material at the gap. This provides flat and parallel surfaces for ease of installation.



Permanent Set: A ring that has been expanded or contracted to a point where its elastic properties have been exceeded and does not return to its original diameter is said to have taken “permanent set”.

Pi-Cut Ends: Term signifying a particular ring design where the ends have been cut in an angular direction from the center of the ring as illustrated below.

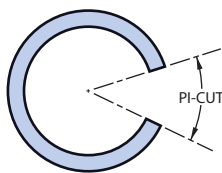

Pitch: Also referred to as helix, this ring dimension is the distance between two adjacent layers of the retaining ring.

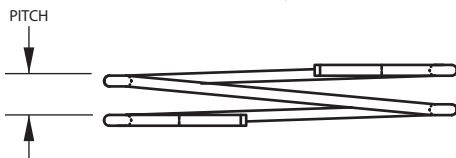

Radial Wall (b): Width of a retaining ring when measured from inside to outside edge.

Radius Notch: (see Removal Notch)

Removal Notch: Also referred to as a “radius notch” or “scallop”, this standard Spirolox Retaining Ring design feature is used to facilitate removal of the ring from its groove by means of a screwdriver or similar type tool.

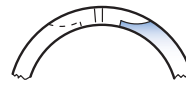

Residual Stress: Stress induced by a cold working process such as edgewinding. It may or may not be beneficial, depending upon the application.

Reverse Wound: (see left hand wound)

Right Hand Wound: Design term signifying the clockwise direction that a Spirolox Retaining Ring is normally wound. (also see Left Hand Wound)

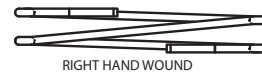

Ring Thickness (T): Total thickness of an edgewound retaining ring. It may be determined by multiplying the material thickness by the number of turns and adding in the keystone value.

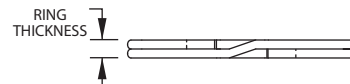

Rod Diameter: (see shaft diameter)

Safety Factor (K): Mathematical constant used in many design formulas to account for theoretical inaccuracies.

Scallop: (see Removal Notch)

Shaft Diameter (D_S): This dimension represents the outside diameter of the assembly where an external retaining ring is installed.

Shear Strength (S_S): An index of the quality of a material through a mathematical expression which divides the force required to shear a material by its cross-sectional area.

Stress Relieve: Low temperature heat treatment for removing any residual stresses induced by edgewinding and/or forming.

Tensile Strength: An index of the quality of a material through a mathematical expression which divides the material's load capacity in tension by its original cross-sectional area. Particularly accurate for spring steels, as there is only a small difference between ultimate tensile strength and yield strength.

Thrust Load Capacity (P_G) or (P_R): Overall capacity of an assembly to withstand a given value of thrust load in pounds. The limitation being the lesser of two mathematical calculations: ring thrust load capacity (P_R) or groove thrust load capacity (P_G).

Yield Strength (S_y): The stress at which a material exhibits initial plastic deformation.

WAVO: Single turn round wire wave spring.



Sample Request Form

Smalley Steel Ring offers **free** samples of catalog retaining rings, constant section rings and wave springs to test in your application.

FAX OR EMAIL NOW!
+1 847 719 5999 • info@smalley.com

Shipping Address

Telephone number required for samples

Name _____

Company _____

Address _____

City/State/Zip Code _____ Country _____

Phone _____ Fax _____

Email _____

Shipping Method

All samples are sent out by US Mail. For expedited delivery, please provide a valid UPS or FedEx account number and specify the service to bill. Please call Smalley at +1 847 719 5900 to request other delivery methods.

Regular US Mail: *(free)*

UPS: Account number for charges *(required)* _____

Ground Overnight 2nd Day

FedEx: Account number for charges *(required)* _____

Overnight 2nd Day

Specific Sample

Please provide us with the part number you would like to test and the requested material:

Smalley Part Number: _____ Carbon Steel Stainless Steel

Smalley Part Number: _____ Carbon Steel Stainless Steel

Assorted Samples

Please send me a sample bag of assorted Smalley retaining rings and wave springs.

Smalley reserves the right to authorize all sample requests.

Spirolox Retaining Rings

No Ears To Interfere®

free samples • free CAD models



Spirolox Rings
Exclusively from
Smalley

COMPATIBLE WITH STAMPED CIRCLIP GROOVES

Uniform cross-section does not interfere with the assembly

Allows for tight radial applications

Exotic alloys available: Inconel, Elgiloy, Titanium and more

STAINLESS STEEL FROM STOCK

6000 stock sizes in carbon and stainless steel (302 & 316)

Available from 6 mm to 400 mm diameters from stock

No-Tooling-Costs™ on specials; available from 5 mm to 3000 mm



www.smalley.com



Lake Zurich, IL • USA • +1 847 719 5900 • info@smalley.com



Coignières • France • +33 130 131 575 • europa@smalley.com



Alingsås • Sweden • +46 322 611 770 • nordic@smalley.com

Smalley Wave Springs

- Reduces spring operating height by 50%
- Wave Springs save space
- Fits tight radial and axial spaces
- 4000 stock sizes in carbon and stainless steel
- No-Tooling-Charges™ on special designs



SMALLEY WAVE SPRING



COIL SPRING

Retaining Rings

- No protruding ears to interfere with assembly
- No gap allows for 360° retaining surface
- No special tools required for removal
- 6000 stock sizes in carbon and stainless steel
- No-Tooling-Charges™ on special designs



SMALLEY	SPIROLOX	MILITARY MIL-DTL-27426	AEROSPACE AS 3219	METRIC AEROSPACE MA 4035	EUROPEAN SPECIFICATION DIN	WALDES TRUARC	EATON	INDUSTRIAL RETAINING RING	OTHER RINGS	ANDERTON
VH	UR	---	---	---						
VS	US	---	---	---						
WH	RR	/3	AS 4299 AS 3217	---						
WS	RS	/1	AS 4299 AS 3218	---						
WHT	RRT	---	---	---	---	---	NAN	---	UHB	---
WST	RST	---	---	---	---	---	XAN	---	USC	---
WHM	RRN	/4	AS 4299 AS 3215	---	---	N5000 5008	IN	3000 4000	HO HOI UHO	N1300
WSM	RSN	/2	AS 4299 AS 3216	---	---	5100 5108	EN	3100 4100	SH SHI USH	N1400
DNH	---	---	---	---	DIN 472	---	---	---	DHO	D1300
DNS	---	---	---	---	DIN 471	---	---	---	DSH	D1400
EH	---	---	---	MA 4017	---	---	---	---	---	---
ES	---	---	---	MA 4016	---	---	---	---	---	---
FH	---	---	---	---	DIN 472	---	---	---	DHO	D1300
FS	---	---	---	---	DIN 471	---	---	---	DSH	D1400
XAH	---	---	---	---	---	---	NAN	---	UHB	---
XAS	---	---	---	---	---	---	XAN	---	USC	---
XDH	---	---	---	---	---	---	ND	---	HN	---
XDS	---	---	---	---	---	---	XD	---	SNL	---
XNH	---	---	---	---	---	---	IN	---	UHO	---
XNS	---	---	---	---	---	---	EN	---	USH	---

GROOVE INTERCHANGE
Use a Smalley Retaining Ring to fit into the same groove of these stamped Retaining Rings (circlips).



Smalley Steel Ring Company

Corporate Headquarters
555 Oakwood Road
Lake Zurich, IL 60047
USA

Phone: +1 847 719 5900
Fax: +1 847 719 5999
Email: info@smalley.com



Smalley Europe

32, Rue des Osiers
78310 Coignières
France

Phone: +33 130 131 575
Fax: +33 130 131 576
Email: europe@smalley.com



Smalley Nordic

Box 653
SE-441 18 Alingsås
Sweden

Phone: +46 322 611 770
Fax: +46 322 611 777
Email: nordic@smalley.com

Smalley WORLDWIDE

Smalley provides customized global supply chain solutions to meet your WORLDWIDE manufacturing requirements in Europe, Asia Pacific and the Americas. For more information, please contact us at: worldwide@smalley.com

Smalley also has representatives that can provide Spanish and Portuguese language support: americas@smalley.com